



External PCMCIA 4X CD-ROM Drive

User's Guide

OPTIONS
by IBM

First Edition (June 1996)

The following paragraph does not apply to the United Kingdom or any country where such provisions are inconsistent with local law: INTERNATIONAL BUSINESS MACHINES CORPORATION PROVIDES THIS PUBLICATION "AS IS" WITHOUT WARRANTY OF ANY KIND, EITHER EXPRESS OR IMPLIED, INCLUDING, BUT NOT LIMITED TO, THE IMPLIED WARRANTIES OF MERCHANTABILITY OR FITNESS FOR A PARTICULAR PURPOSE. Some states do not allow disclaimer of express or implied warranties in certain transactions, therefore, this statement may not apply to you.

This publication could include technical inaccuracies or typographical errors. Changes are periodically made to the information herein; these changes will be incorporated in new editions of the publication. IBM may make improvements and/or changes in the product(s) and/or the program(s) described in this publication at any time.

It is possible that this publication may contain reference to, or information about, IBM products (machines and programs), programming, or services that are not announced in your country. Such references or information must not be construed to mean that IBM intends to announce such IBM products, programming, or services in your country.

Requests for technical information about IBM products should be made to your IBM reseller or IBM marketing representative.

© Copyright International Business Machines Corporation 1996. All rights reserved.

Note to U.S. Government Users — Documentation related to restricted rights — Use, duplication or disclosure is subject to restrictions set forth in GSA ADP Schedule Contract with IBM Corp.

Contents

About This Book	iv
<hr/>	
Part 1: Quick Installation Guide	1-1
<hr/>	
Part 2: User's Guide	2-1
Introduction	2-1
Top of Drive	2-2
Bottom of Drive	2-2
External Connectors of Drive	2-3
Operator Display Panel	2-3
Installation Requirements	2-4
Handling Instructions	2-4
Separately Available Products	2-5
Installing the Drive	2-5
Step 1. Connecting the Drive Power	2-5
Step 2. Connecting the Drive	2-8
Step 3. Installing the Drive Software	2-9
Step 4. Completing the Installation	2-13
Using the Drive	2-14
Position the Speakers (Stereo Model Only)	2-14
Using a Data CD	2-15
Playing an Audio CD	2-17
Using Windows 3.1 Audio Utility	2-19
Maintaining the Drive	2-21
<hr/>	
Part 3: Appendixes	3-1
Appendix A. Help and Service Information	3-1
Step 1: Troubleshooting	3-1
Step 2: Preparing for the Call	3-2
Step 3: Placing the Call to IBM	3-3
Appendix B. Product Warranty and Notices	3-3
Notices	3-5
Trademarks	3-6
Laser Compliance Statement	3-6
Electronic Emission Notices	3-6

About This Book

This book is intended for the person who installs the External PCMCIA 4X CD-ROM Drive with a computer having a PCMCIA adapter. This book is divided into three parts:

- Part 1 contains abbreviated installation instructions in the following languages:

English	German
French	Spanish
Italian	Brazilian Portuguese
- Part 2 provides information on how to prepare for, install, and use your CD-ROM drive.
- Part 3 contains help and service information, notices, warranty, and trademark information.

Note: The illustrations in this publication might be slightly different from your hardware.

Part 1: Quick Installation Guide

The following is an overview of the CD-ROM drive installation instructions. For more detailed instructions, go to "Part 2: User's Guide" on page 2-1. The CD-ROM drive comes in a base and stereo model. The stereo model includes a sound adapter and speakers, the base model does not. The following illustrations are for the stereo model, but you can use these illustrations to locate external connectors and controls on both models.

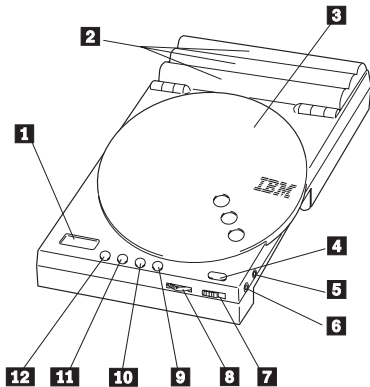

- 1** Operator display panel
- 2** Battery cover
- 3** CD cover
- 4** Open button

- 5** Line output jack (for connection to an audio system)
- 6** Headphone jack (green)
- 7** CD cover-lock button
- 8** Volume control
- 9 10 11 12** Standalone CD-operation buttons

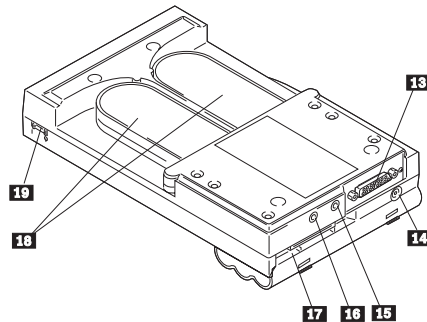

- 13** Joystick connector (stereo model only)
- 14** AC adapter jack (yellow)
- 15** Line input jack (stereo model only)
- 16** Microphone jack (stereo model only)
- 17** Bus connector
- 18** Built-in speakers (stereo model only)
- 19** Power switch

Installing the Drive

1. Select a power source for the CD-ROM drive: AC adapter, Ni-Cd battery pack (rechargeable battery pack), or six AA alkaline batteries.

Note: Do not insert or remove the interface cable connectors crooked or with excessive force since this might damage the connectors.

2. Connect the interface cable connector with the AMP mark facing up to the end of the PCMCIA card with the large IBM logo facing up. Connect the other end of the interface cable with the AMP mark facing up to the CD-ROM drive bus connector **17**. Insert the interface cable connector straight while simultaneously pushing the right and left latches on the connector.
3. Turn on the computer and turn on the CD-ROM drive by moving the power switch **19** to the ON position.
4. If installing under DOS and Windows 3.1x:
 - a. Insert the Setup Diskette into drive A. At the DOS prompt enter **install**, then follow the instructions on the screen. When installation completes, restart DOS.
 - b. If installing the stereo model, start Windows 3.1x. Insert Sound Diskette 1 into drive A and run **SETUP.EXE** using the Windows 3.1x File menu. When the installation process completes, restart Windows.
5. If installing under Windows 95: Turn on the computer. Windows 95 recognizes a new drive and displays the *New Hardware* window. Click on **OK** and follow the instructions. When the installation process completes, restart Windows 95.
6. If installing the base model under OS/2 Warp: Insert the Setup Diskette into drive A. Double-click on **Device Driver Install** in the **System Setup** folder. Click on **Install** and follow the instructions on the screen. When the installation process completes, shut down and restart OS/2.
7. If installing the stereo model under OS/2 Warp:
 - a. Verify that the IBM Multimedia Presentation Manager/2 (MMPM/2) is installed on the computer.
 - b. Insert the Setup Diskette into drive A. Double-click on **Device Driver Install** in the **System Setup** folder. Click on **Install** and follow the instructions. Shut down the system and restart OS/2.
 - c. Insert the Setup Diskette in drive A. Double-click on **MINSTALL.EXE** from **Drive A**. Select *External 4X PCMCIA*, click on **Install**, and follow the instructions. When the installation process completes, shut down and restart OS/2.

Ni-Cd Battery Pack Disposal: Dispose of the battery as required by local ordinances or regulations. In the United States, call 1-800-IBM-4333 for disposal information.

Introduction

The External PCMCIA 4X CD-ROM Drive reads a compact disc (CD) containing 600 MB¹ of information. The drive operates at up to four times (4X) the standard CD-ROM speed. You can use the CD-ROM drive connected to your computer or as a portable audio CD player. The drive comes in two models:

- External PCMCIA 4X CD-ROM Drive (base model)
The base model is a portable CD-ROM drive. It does not include a sound adapter or speakers. To hear sound using speakers, the computer must have a sound adapter previously installed.
- External PCMCIA 4X Stereo CD-ROM Drive (stereo model)
The stereo model is a portable CD-ROM drive that includes a sound adapter and speakers.

The illustrations in this manual are for the stereo model but the illustrations can be used to locate controls and external connectors on both models.

You can use the drive by inserting the PCMCIA card into the PCMCIA slot in the computer. The drive has three power source options: AC adapter, Nickel-Cadmium (Ni-Cd) battery pack, and alkaline batteries (available at stores).

In addition to this manual, the option package contains:

- Base model or stereo model of the CD-ROM drive
- PCMCIA card
- AC adapter
- Power cord for the AC adapter
- Bus interface cable (interface cable)
- Nickel-Cadmium (Ni-Cd) battery pack
- Setup Diskette
- Two Sound Diskettes with the stereo model (used only with Microsoft Windows 3.1x)

If any item in the options package is missing or damaged, contact your place of purchase. Be sure to retain your proof of purchase; it might be required to receive warranty service.

¹ MB equals approximately 1 000 000 bytes capacity.

Top of Drive

The following illustration shows the top view of the drive identifying the connectors and controls.

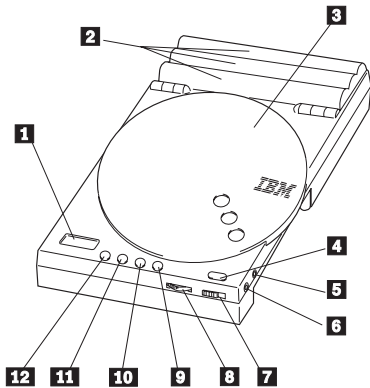

- 1** Operator display panel
- 2** Battery cover
- 3** CD cover
- 4** Open button
- 5** Line output jack (for connection to an audio system)
- 6** Headphone jack (green)
- 7** CD cover-lock button

- 8** Volume control
- 9 10 11 12** Standalone² CD-operation buttons

Bottom of Drive

The following illustration shows the bottom view of the drive identifying the connectors and power switch.

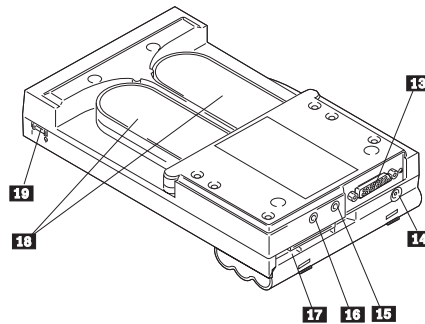

- 13** Joystick connector (stereo model only)
- 14** AC adapter jack (yellow)
- 15** Line input jack (stereo model only)
- 16** Microphone jack (stereo model only)
- 17** Bus connector
- 18** Built-in speakers (stereo model only)
- 19** Power switch

² The CD-ROM drive is not connected to the computer using the bus connector.

External Connectors of Drive

You can use the CD-ROM drive to read data CDs or play audio CDs. These functions are described in “Using the Drive” on page 2-14. The drive external connectors (refer to the illustrations on page 2-2) provide options to allow you to:

- Send an audio signal to an external audio system using the line out jack **5**.
- Connect headphones using the headphone jack **6**.
- Connect a joystick using the joystick connector **13** to play games (stereo model only).
- Feed the audio signal into the drive using the line input jack **15** (stereo model only):
 - Listen to the sound on the drive speakers
 - Route the signal to the computer for recording digital audio files
- Connect a microphone using the microphone jack **16** (stereo model only):
 - Output the sound to the speakers
 - Route the signal to the computer for recording digital audio files
- Route the audio signal or digital data from the drive to the computer through the bus connector **17**.

On the stereo model, the speakers do not operate with the headphones connected to the headphone jack **6**.

Operator Display Panel

Use the operator display panel to determine the operational state of the CD-ROM drive. The following illustration shows the position of each indicator on the display panel when the indicator is active. The table shows the meaning of each indicator.

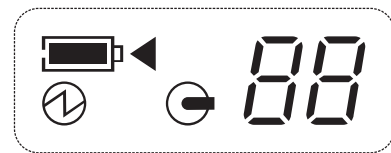







Table 1. Operator Display Indicators

	Battery power sufficient
	Battery power low (when flashing)
	Battery being charged
	Accessing CD
	Power on
	CD track number playing CD operation paused (when flashing)

Installation Requirements

To install the CD-ROM drive you must have:

- IBM or IBM-compatible computer with a 3.5-inch diskette drive
- Slot for PCMCIA card type II
- PCMCIA card service support
- Headphones (optional) for use with the CD-ROM drive
- The documentation that comes with your computer and operating system.

Only one CD-ROM drive can be used with the computer, even if the computer has more than one PCMCIA card slot.

Use the drive with one of the following operating systems:

- Windows 3.1 or later with DOS 5.0 or later

If you are installing the stereo model and the computer already has a sound adapter, disable the adapter. To disable the sound adapter, refer to the instructions that come with your computer or sound adapter.

- OS/2 Warp 3.0 or later

If installing the stereo model, you must have the IBM Multimedia Presentation Manager/2 (MMPM/2) installed. For information about MMPM/2 and how to install it, see the OS/2 Warp documentation.

- Windows 95

Handling Instructions

Read these instructions to preserve and care for the CD-ROM drive:

- Only use the AC adapter in the options package with the drive.
- Do not hold the drive by the CD cover when the cover is open.
- Do not hold the drive by the speakers (stereo model only).
- Do not expose the drive to:
 - High temperature or direct sunlight
 - Excessive dust
 - Excessive vibration or sudden shock
 - Abrupt movement from cold to warm room (condensation might develop)
 - High humidity (might affect proper operation)
- Do not press the cover strongly or stack objects on the drive.
- Do not use a strong solution such as benzene or thinner to clean the drive. The solvent causes deformation or discoloration.

Only use the Ni-Cd battery pack that comes with the CD-ROM drive. Dispose of the battery as required by local ordinances or regulations. In the United States, call 1-800-IBM-4333 for disposal information.

Separately Available Products

The Ni-Cd battery pack and the AC adapter can be purchased separately. The part numbers are:

- For United States, Canada, and Puerto Rico:
 - Ni-Cd battery pack (IBM part number is 41H9719)
 - AC adapter (IBM part number is 41H9722)
- For Europe:
 - Ni-Cd battery pack (IBM part number is 41H9727)
 - AC adapter (IBM part number is 41H9723)

For other locations, contract your IBM reseller or IBM marketing representative.

Installing the Drive

Use the following steps to connect and install the software for the CD-ROM drive. Refer to the illustrations on page 2-2 of the top and bottom of the drive to identify the drive external connectors and controls.

Step 1. Connecting the Drive Power

Select a power source option to operate the CD-ROM drive:

- AC adapter connected to a power outlet
- Ni-Cd battery pack
- Six AA alkaline batteries

This step also includes Ni-Cd battery pack recharging instructions.

Using an AC Adapter

Follow these steps to use the AC adapter to connect the CD-ROM drive to a power outlet.

Note: Do not use a substitute for the AC adapter provided with the option package since it might damage the CD-ROM drive.

1. Verify that the CD-ROM drive is off by observing a blank operator display panel **1** or by moving the power switch **19** to the OFF position.
2. Connect the AC adapter to the AC adapter jack **14**. The AC adapter and the adapter jack are colored yellow.
3. Connect the AC adapter power cord to the AC adapter.
4. Connect the AC adapter power cord to a power outlet.
5. Turn on the CD-ROM drive by moving the power switch **19** to the ON position. On the operator display panel, the following indicator appears: .



Using a Ni-Cd Battery Pack

Follow these steps to use the Ni-Cd battery pack to power the CD-ROM drive.

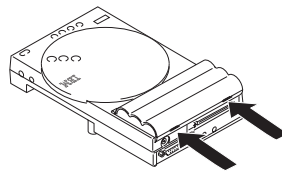
1. Open the battery cover **2** by inserting an object such as a ballpoint pen in one of the two slits in the rear of the CD-ROM drive just below the battery cover. Use the following figure to identify the location of the slits.





2. Lift the battery cover up.
3. Leave the battery removal ribbon lying on the bottom of the case with the end extended outside the battery case.
4. Position the battery pack with the three metal electrodes (negative polarity) facing the three springs at one end of the battery case. Then insert the Ni-Cd battery pack into the battery case. The battery pack shape makes it only fit one way.
5. Fold the battery removal ribbon over the battery pack.
6. Close the battery cover **2**.
7. Turn on the CD-ROM drive by moving the power switch **19** to the ON position. On the operator display panel, the following

indicators appear:  and . (The  only appears on the display panel if the AC adapter is not being used and the battery pack is charged.)

If you have to remove the battery pack, open the battery cover **2** and pull on the battery removal ribbon to dislodge the battery pack.

Charging the Ni-Cd Battery Pack

You can only charge the Ni-Cd battery pack when it is in the CD-ROM drive. Follow these steps to charge the battery pack:

1. Verify that the provided Ni-Cd battery pack is in the CD-ROM drive.
2. Turn off the power to the CD-ROM drive using the power switch **19**.
3. Connect the AC adapter power cord to a power outlet.
4. Press the button  to start the charging process. (You cannot use this button to stop the charging process.)
5. The charging indicator appears:  on the operator display panel.

Do not stop the charging process once you start it. Stopping the charging process before it completes shortens the life of the Ni-Cd battery pack. Charging takes about five hours. The charging indicator disappears when the battery is charged.

If the life of the battery becomes very short, use up the remaining life to drain the battery, then charge the battery. If no improvement is

noticed, the Ni-Cd battery pack might be at the end of its useful life. Replace the battery pack. You can obtain a replacement Ni-Cd battery pack, see “Separately Available Products” on page 2-5.



Using Alkaline Batteries

Follow these steps to use alkaline batteries to power the CD-ROM drive:

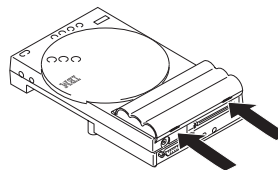
1. Open the battery cover **2** by inserting an object such as a ballpoint pen in one of the two slits in the rear of the CD-ROM drive just below the battery cover. Use the following figure to identify the location of the slits.



2. Lift the battery cover up.
3. Leave the battery removal ribbon lying on the bottom of the case with the end extended outside the battery case.
4. Insert six AA alkaline batteries into the battery case following the diagram markings on the bottom of the battery case. Replace all the batteries using batteries from one manufacturer. Do not combine new and old batteries.
5. Fold the battery removal ribbon over the batteries.

6. Close the battery cover **2**.
7. Turn on the CD-ROM drive by moving the power switch **19** to the ON position. On the operator display panel, the following indicators appear:  and . (The  only appears on the display panel if the AC adapter is not being used and the battery pack is charged.)

If you do not plan to use the alkaline batteries for a long time, or the batteries reach the end of their useful life, remove all the batteries from the drive.

If you have to remove the batteries, open the battery cover **2** and pull on the battery removal ribbon to dislodge the batteries.

Step 2. Connecting the Drive

Follow these instructions to connect the CD-ROM drive to your computer.

Note: Do not insert the cable connectors crooked or with excessive force since this might damage the connectors.

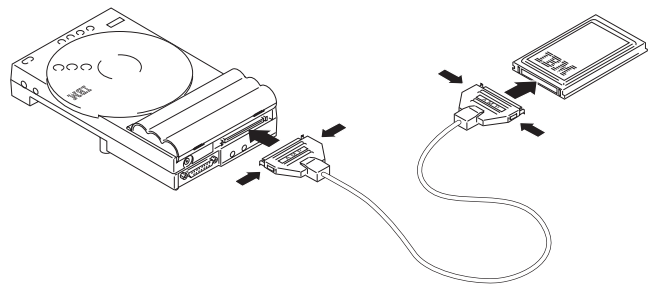

1. Connect the interface cable connector with the AMP mark facing up to the end of the PCMCIA card with the large IBM logo facing up. Insert the interface cable connector straight while simultaneously pushing the right and left latches on the connector.
2. Connect the other end of the interface cable with the AMP mark facing up to the bus connector **17** simultaneously pushing the right and left latches on the connector.
3. Insert the PCMCIA card into the PCMCIA slot of the computer. The PCMCIA card might have to be inserted upside down

depending on the computer. Do not forcibly insert the PCMCIA card.

You can replace or remove the PCMCIA card while the computer is operating and continue using the drive. Do not remove the PCMCIA card during CD-ROM access.

Note: If you remove the interface cable connectors without depressing the right and left latches or with excessive force, you might damage the interface cable connectors.

To remove the interface cable connectors, simultaneously depress the right and left latches on the connector and pull straight out.

Step 3. Installing the Drive Software

Use the installation instructions for the operating system installed in your computer.

DOS and Windows 3.1x

Use these instructions for both the base model and stereo models:

1. Turn on the computer and turn on the CD-ROM drive by moving the power switch **19** to the ON position.
2. Insert the Setup Diskette into drive A.
3. At the DOS prompt, type **A: install**, and press **Enter**.
4. Select one of the following options, then press **Enter**:
 - *Automatic Installation*— Installs the driver and updates the CONFIG.SYS and AUTOEXEC.BAT files.
 - *Custom Installation*— Installs the driver and updates the CONFIG.SYS and AUTOEXEC.BAT files but first it lets you change the default IRQ number and I/O base address.
5. You must confirm the selection by selecting **Yes**. Use the **Up Arrow**(↑) or **Down Arrow**(↓) key to make your selection. Press **Enter**. A message appears requesting that you restart the computer to make the changes to the system.
6. Restart DOS.

Windows 3.1x Audio Utility (Stereo Model Only)

The stereo model provides an audio utility for Windows 3.1x that includes sound and miscellaneous functions. Follow these steps to install the utility:

1. Start Windows 3.1x. (You will hear the Windows startup sound if you have successfully installed the device driver.)
2. Insert the Sound Diskette 1 into drive A.
3. Start the installation program.
 - a. Click on **File** from the Program Manager menu bar.
 - b. Click on **Run** from the menu list.
 - c. Type **A: setup**, and press **Enter**.
4. Review the *Welcome to ..* and click on **Continue**.
5. Click on **Software Installation**.
6. Verify the directory where for the audio utility (default is C:\PCAUDIO), then click on **OK**. You will be prompted to confirm the directory selection. Click on **Confirm Directory**.
7. Select one of the following options:
 - *Complete Installation* to install all the utility functions.
 - *Custom Installation* to install selected utility functions.
8. Follow the instructions and click on **Exit** when the process completes.

If you have to resolve a resource conflict or want to customize the installation, you can edit the CD-ROM device driver statement in the CONFIG.SYS file:

```
DEVICE=C: \CD400\PCMCDSND.SYS /I:nn /P:nnn /D:aaaaaa  
/NOBEEP]
```

Where:

- /I:nn** To assign an IRQ number (**nn**) to the device driver. The IRQ levels you can use with the CD-ROM drive are 7, 9, 11, and 15.
- /P:nnn** To assign a specific I/O address (**nnn**) (hexadecimal) CD-ROM drive.
- /D:aaaaaaaa** To specify another device name (**aaaaaaaa**) for MSCDEX.
- /NOBEEP** To make the device not beep at the insertion of the PCMCIA card.

Windows 95

Use these instructions for both the base model and stereo models. The Windows 95 installation process leads you through the installation process once started. Follow these steps:

1. Turn on the computer and turn on the CD-ROM drive by moving the power switch **19** to the ON position. The CD-ROM drive must be connected to the computer.
2. Start Windows 95.
3. Windows 95 recognizes a new drive and displays the *New Hardware* window. Select **Driver Provided by Hardware Manufacturer**, and click on **OK**.
4. Insert the Setup Diskette into drive A.
5. When you see *Install From Disk*, click on **OK**.
6. When you see the message, *Do you want to restart your computer now?*, click on **YES**. Remove the Setup Diskette from drive A.

OS/2 Warp with the Base Model

Use these instructions to install the base model under OS/2 Warp:

1. Turn on the computer and turn on the CD-ROM drive by moving the power switch **19** to the ON position.
2. Insert the Setup Diskette into drive A.
3. Double-click on the **OS/2 System** folder and then on **System Setup**.
4. Double-click on **Device Driver Install**.
5. Modify the destination directory and path or accept the default destination path, then click on **Install**.
6. Click on **OK** on the *Installation Information* window. Note that *Selective Install* is not required when using these instructions.
7. Click on **Exit** on the *OS/2 Device Driver Installation* window.
8. Click on **YES** when the message, *Exit the program* appears.
9. Click on **OK** when the message, *Changes have been made to your system configuration. You must perform a shutdown and restart OS/2 for these changes to take effect.* appears.

OS/2 Warp with the Stereo Model

Use these instructions to install the stereo model under OS/2 Warp:

1. Verify the presence of Multimedia Presentation Manager:
 - a. Start OS/2.
 - b. If the MMPM/2 is installed on the computer, the Multimedia folder is on the OS/2 desktop. If MMPM/2 is not installed, refer to the OS/2 Warp documentation for installation instructions.
2. Install the CD-ROM Device Driver:
 - a. Turn on the computer and turn on the CD-ROM drive by moving the power switch **19** to the ON position.
 - b. Insert the Setup Diskette into drive A.
 - c. Double-click on the **OS/2 System** folder and then on **System Setup**.
 - d. Double-click on **Device Driver Install**.
 - e. Modify the destination directory and path or accept the default destination path, then click on **Install**.
 - f. Click on **OK** on the *Installation Information* window. Note that *Selective Install* is not required during this part of the installation.
 - g. Click on **Exit** on the *OS/2 Device Driver Installation* window.
 - h. Click on **YES** when the message, *Exit the program* appears.
 - i. Click on **OK** when the message, *Changes have been made to your system configuration. You must perform a shutdown and restart OS/2 for these changes to take effect.* appears.
 - j. Shut down and restart OS/2.
3. Install Sound Support
 - a. Insert the Setup Diskette into drive A.
 - b. Double-click on **OS/2 System** and then on **Drives**.
 - c. Double-click on **Drive A**.
 - d. Double-click on **MINSTALL.EXE** to start the program.
 - e. Click on **External 4X PCMCIA** if it is not already selected, then click on **Install**.
 - f. Click on **Yes** on the *MMPM/2 Change CONFIG.SYS* window.
 - g. Verify that the number of devices is **1** on the *Multimedia Installation* window, then click on **OK**.
 - h. Click on **OK** when the message *MMPM/2-CONFIG.SYS Changed* appears.
 - i. Click on **OK** when the message: *MMPM/2 Installation Successful.* appears.
 - j. Shut down and restart OS/2.

If you have to resolve a resource conflict or want to customize the installation, you can edit the CD-ROM device driver statement in the CONFIG.SYS file:

```
BASEDEV=CD400CRD.SYS [/P:nnn] [/EXIRQ:n]
[/NOBEEP]
```

/P:nnn To assign a specific I/O address (**nnn**) (hexadecimal) to the CD-ROM drive.

/EXIRQ: n To exclude the specified IRQ number (**n**). The program assigns another IRQ number to the CD-ROM drive. The IRQ levels you can use with the CD-ROM drive are 7, 9, 11, and 15.

/NOBEEP To make the device not beep at the insertion of the PCMCIA card.

Step 4. Completing the Installation

Ensure that you have shut down and restarted the operating system so that you can use the drive. Note the following results from the installation process:

- The installation process assigns a drive letter to the CD-ROM drive. If the computer has more than one PCMCIA card slot, the process identifies the slot with the CD-ROM PCMCIA card and enables access to the drive.
- The drive letter assigned at installation remains unchanged even if the PCMCIA card is inserted into another available slot.
- The CD-ROM drive operates the same regardless of whether the computer starts with or without the PCMCIA card inserted into the PCMCIA card slot.
- If using stereo model under OS/2 Warp, new icons are added to the Multimedia folder when the stereo model sound support has been installed. To use the sound support, double-click the corresponding icon.

Using the Drive

Refer to the illustration “Top of Drive” on page 2-2 when loading a CD:

1. Press **Open 4** to release the CD cover **3**.
2. Lift the CD cover up until it snaps into the open position.
3. Do not hold the CD by the edges. Do not touch the surface of the CD.
4. Insert the CD on the drive with the label facing up. Press the CD until it is set firmly at the center with a click.
5. Close the cover.

To remove a CD:

1. Press **Open 4** to release the CD-ROM cover **3**.
2. Lift the edge of the CD edge while pressing the center of the CD.
3. Close the cover.

Position the Speakers (Stereo Model Only)

The built-in speakers of the stereo model are provided to play back sound and audio CDs. To position the speakers:

1. Pull out the right and left speakers from the bottom of the drive until that are parallel with the drive.

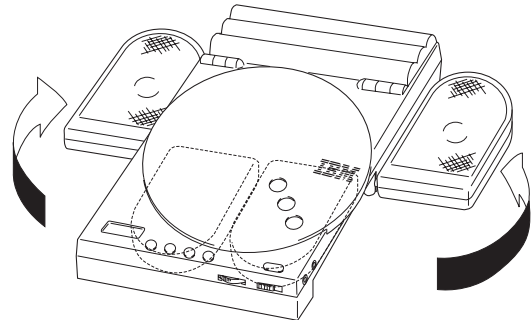

2. Raise the speakers until you hear a click. Do not forcibly turn the raised speakers to the inside.

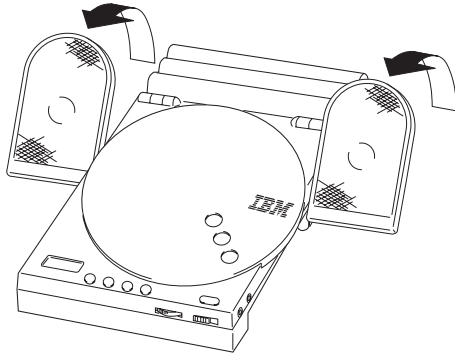

To return the speakers back to their storage positions:

1. Push the speakers flat.

Note: Rotating the speakers before positioning them flat might cause damage to the device.

2. Rotate the speakers back to the storage position.

Using a Data CD

You can use a data CD to read data files, play games, or run applications. The instructions to use a data CD depends on your operating system.

DOS

To use a data CD:

1. Turn on the computer and turn on the CD-ROM drive by moving the power switch **19** to the ON position. The operating system displays messages shown below (drive D is the CD-ROM drive in this example):

```
MSCDEX Version 2.2.3  
Copyright (c) Microsoft Corp. 1986-1993
```

```
Drive D:=Driver PCMC001 unit 0
```

2. Load a data CD.
3. At the DOS prompt, type **dir d:**, and press **Enter**.
4. Verify that you can view the files on the CD.

Windows 3.1x

To use a data CD:

1. Turn on the computer and turn on the CD-ROM drive by moving the power switch **19** to the ON position.
2. Load a data CD.
3. Double-click on **File Manager**.
4. Verify that the *CD* icon is displayed.
5. Double-click on **CD-ROM**.
6. Verify that you can view files on the CD.

Windows 95

To use a data CD:

1. Turn on the computer and turn on the CD-ROM drive by moving the power switch **19** to the ON position.
2. Load a data CD.
3. Click on **My Computer**.
4. Verify that the *CD* icon is displayed.
5. Click on **CD-ROM**.
6. Verify that you can view files on the CD.

OS/2 Warp

To use a data CD:

1. Turn on the computer and turn on the CD-ROM drive by moving the power switch **19** to the ON position.
2. Load a data CD.
3. Double-click on **OS/2 System** and then **Drive**.
4. Verify that the *CD* icon is displayed.
5. Double-click on **CD**.
6. Verify that you can view files on the CD.

Note that if the PCMCIA card is connected when you start the computer, turn on the power to the CD-ROM drive before you bring up OS/2.

Playing an Audio CD

You can control audio CD play by:

- Using audio utility controls on the computer
- Using CD controls on the drive

Using Audio Utility Controls on the Computer

When you play a CD through the computer, use the audio CD control functions available on your operating system. You can adjust the volume with either the volume control in your audio program or with the volume control on the CD-ROM drive. (Note that the standalone CD operation controls, **9 10 11 12**, do not function when the drive is connected to the computer.)

The instructions to play an audio CD depends on your operating system.

Windows 3.1x

To use the Windows audio utility:

1. Turn on the computer and turn on the CD-ROM drive by moving the power switch **19** to the ON position.
2. Load an audio CD.
3. Double-click on **Accessories**.
4. Double-click on **Media Player**, and then on **Device**.
5. Select **CD Audio**.

If you do not see the *CD Audio* on the *Media Player* device menu list, you must install the Windows CD Audio driver. To install the driver, use the following instructions or refer to the Windows documentation for details:

1. Double-click on **Main, Control Panel**, and then **Drivers**.
2. Click on **Add**
3. Select **MCI CD Audio**, click on **OK**, and then follow the directions.
4. Click on **Close**.
5. Restart Windows.

Windows 95

To use the Windows 95 audio utility:

1. Turn on the computer and turn on the CD-ROM drive by moving the power switch **19** to the ON position.
2. Load an audio CD.
3. Click on **Start**.
4. Select **Programs, Accessories, Multimedia**, and then **Media Player**.
5. Click on **Media Player**.
6. Click on **Device**.
7. Select **CD Audio**.

OS/2 Warp





To use the OS/2 audio utility:

1. Turn on the computer and turn on the CD-ROM drive by moving the power switch **19** to the ON position.
2. Load an audio CD.
3. Open **Multimedia**.
4. Select and start **Compact Disk**.

Note that if the PCMCIA card is connected when you start the computer, turn on the power to the CD-ROM drive before you bring up OS/2.

Using CD Controls on the Drive

You can play an audio CD on the CD-ROM drive as a standalone unit. The CD-ROM drive is a standalone unit when it is not connected to the computer. Use the CD standalone operation buttons, **9 10 11 12**, to control audio CD play. The functions of the CD standalone operation buttons are:

Button	Function
	Starts and pauses playing the CD.
	Stops playing the CD.
	Skips to the next tune when pressed once. Skips to the tune after the next one when pressed again.
	Returns to the beginning of the current tune when pressed once. Returns to the previous tune when pressed at the beginning of a tune.

Using Windows 3.1 Audio Utility

The stereo model provides an audio utility for Windows 3.1x with an Audio Applications program group that includes audio and miscellaneous programs. (Refer to “Windows 3.1x Audio Utility (Stereo Model Only)” on page 2-10 for the installation instructions.) Double-click on **Audio Applications** program group to view the functions available. The primary audio functions included are the:

- Audio Recorder
- Extended Recorder

Audio Recorder

Use the Audio Recorder to:

- Record digital audio files from voice, music and other sound sources.
- Playback audio files.
- Edit digital audio files by cutting, copying and pasting a waveform.
- Embed sound objects in documents created in applications that support object linking and embedding (OLE).

The Audio Recorder Help function has additional information not included in this manual.

Making a Digital Recording

With the Audio Recorder, you can record files with a .WAV or .AUD file extension. You can record an audio signal from a microphone, cassette tape player, CD player, or any other line-in source using the external drive connectors, reference “External Connectors of Drive” on page 2-3.

Follow these steps to make a digital recording:

1. Double-click on **Recording Control** and use this window to control the mix of audio sound to record from one or more sources. (If you do not open the Recording Control window, the Audio Recorder uses the sound source settings previously in effect.) Recording Control provides options to:
 - a. Select the input source or sources to be recorded (*Line, Mic, and CD*). (The *Synth* and *AuxB* sources are not supported with the CD-ROM drive.)
 - b. Adjust the volume of each selected input source by moving the (*Vol*) slide up or down.
 - c. Adjust the volume balance between the right and left speakers for each selected input source by moving the (*Vol*) slide left or right.
 - d. Adjust the volume and balance of the *Master* to control the recorded signal from all the sound sources selected.
2. Double-click on **Audio Recorder**.
 - a. Click on **New File** or select **New** from the File menu.

- b. Select the Sound Attributes to specify the audio fidelity of the recorded file:
 - Mono or stereo
 - Sampling rate³ (11, 22, or 44 kHz)
 - Sample size (8-bit or 16-bit)
 - c. Click on **OK**.
 - d. Click on **Record** button to record the input source selected.
 - e. Click on **Stop** button to pause or end the recording.
3. Select **File** from the menu bar.
 4. Select **Save as** and specify the file name and file extension (**.WAV** or **.AUD**).

You can make a high fidelity audio file using stereo, a 16-bit sample size, and a high sampling rate. A high fidelity recording can use large amounts of disk space. For efficient use of file space when recording, consider:

- Recording in mono rather than stereo. Mono mode takes one sample at a time rather than one for the right and left channel.
- Using the lowest sample rate practical.
- Using an 8-bit sample size rather than 16-bit for speech and sound effects when possible.

Playing an Audio File

You can play an audio file with the following file extensions: .WAV, .AUD, .MID and .MFF.

To play an audio file, follow these steps from the Audio Recorder window:

1. Select a sound file by using the File menu on the menu bar.
2. Click on **Play** button to hear the audio file.
3. Select *Volume Control* from the Options menu to regulate the playback sound level or stereo balance.
4. Select *Mixer* from the Options menu to play the current audio file together with the other sound sources.

Extended Recorder

Use the Extended Recorder to recording and playback audio files of meetings, conversations, and dictation using a 4-bit format (sample size) sound attribute. The 4-bit format is a low fidelity specification but it allows you to capture longer conversations using less file space than larger sample sizes.

The Extended Recorder has a voice activation option to pause the recording when there is no input from the recording source.

You can use the Extended Recorder Help function to obtain additional information.

³ The stereo model does not support sampling rates of 5.5 and 8 kHz.

Maintaining the Drive

Use the following instructions to clean your drive and CDs:

- **Cleaning the Surface of the CD-ROM Drive**— Lightly wipe the CD-ROM drive with a dry soft cloth. If stains remain on the surface, use a damp cloth (soak cloth in a diluted mild detergent and squeeze it firmly). Do not use solvents such as thinner, alcohol, and benzene. They cause deformation and discoloration.
- **Cleaning the Lens**— If the lens is dirty, the CD-ROM drive might not operate correctly. Clean the lens with a CD lens cleaner (available at stores).

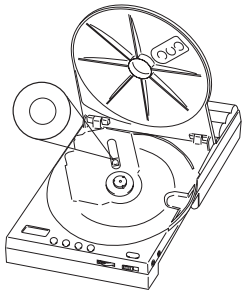

- **Cleaning the CD**— Clean the CD with a soft cloth from the center to the outside radially. If stains remain on the disk, clean it with a damp cloth (soak cloth in water and squeeze it firmly). Then, wipe the disk with a dry soft cloth. Do not use record cleaner or antistatic spray.

Appendix A. ***Help and Service Information***

Before calling, please prepare for your call by following these steps.

Step 1: Troubleshooting

You might be able to solve the problem yourself. If you observe one of the following problems, one of the associated responses might fix the problem.

1. **No symbol appears at power-on:**
 - a. Verify that the AC adapter is connected correctly, see "Using an AC Adapter" on page 2-6.
 - b. Verify that the Ni-Cd battery pack is inserted correctly, see "Using a Ni-Cd Battery Pack" on page 2-6.
 - c. Verify that the Ni-Cd battery pack is fully charged, see "Charging the Ni-Cd Battery Pack" on page 2-7.
 - d. Verify that the AA alkaline batteries are inserted correctly, see "Using Alkaline Batteries" on page 2-7.
 - e. Verify that the batteries are still useful. If the batteries are weak, the battery power indicator will flash (see Table 1 on page 2-3).
2. **The CD-ROM drive is not recognized on the computer:**
 - a. Verify that the required software is installed correctly, see "Step 3. Installing the Drive Software" on page 2-9.
 - b. If you are using Windows 95, your computer model might require a BIOS upgrade. Consult with the computer manufacturer for a BIOS upgrade diskette. IBM Thinkpads models generally require the BIOS upgrade.
3. **The CD-ROM drive fails to operate normally:**
 - a. Verify that the PCMCIA card and interface cables are connected correctly, see "Step 2. Connecting the Drive" on page 2-8.
 - b. Verify that the card and cable connectors are normal and that they are not bent or broken.
 - c. Verify that the CD is loaded properly, see "Using the Drive" on page 2-14.
 - d. Verify that the CD cover is closed firmly., see "Using the Drive" on page 2-14.
 - e. Verify that you are not trying to play an audio CD using the standalone CD operation buttons while the drive is connected to the computer. You can only use the standalone CD operation buttons to play an audio CD when the device is not connected to the computer.

- f. Verify that the correct drive letter is used, see “Step 4. Completing the Installation” on page 2-13 to access the drive.
- g. The CD-ROM drive might fail to operate normally if another PCMCIA card has been installed in your computer.

4. No sound from the speakers (stereo model only):

- a. Verify if the headphones are connected. The speakers do not function if you are using the headphone jack.
- b. Verify the setting volume control adjustments on the drive and the computer audio utility.

5. A CD can be played on the CD-ROM drive, but it cannot be played through the computer:

Verify that the required software is installed correctly, see “Step 3. Installing the Drive Software” on page 2-9.

6. Sound from the headphones is too low:

Verify that the headphones are connected to the LINE OUT terminal by mistake, see “Introduction” on page 2-1. Plug the headphones into the headphone jack (color coded green).

7. No sound from an audio CD:

Verify that the sound specification of the computer is correct, such as the a resource conflict with IRQ or base I/O address. If you have a base model, check the specifications for the sound adapter on the computer.

8. Unusual sound or data cannot be read:

- a. Clean the CD-ROM disk with soft cloth from the center to the outside radially.
- b. Clean the CD-ROM drive lens with a camera lens blower or with CD lens cleaner, see “Maintaining the Drive” on page 2-21.

Step 2: Preparing for the Call

To assist the technical support representative, have available as much of the following information as possible:

1. Computer manufacturer and computer model
2. Option name: External PCMCIA 4X CD-ROM Drive
3. Proof of purchase
4. Exact wording of the error message (if any)
5. Description of the problem
6. Hardware and software configuration information for your system

If possible, be at your computer. Your technical support representative might want to walk you through the problem during the call.

Step 3: Placing the Call to IBM

Technical support⁴ is available during the warranty period to answer any questions about your new IBM option.

For the support telephone number and support hours by country, use the following table. For other countries, contact your IBM reseller or IBM marketing representative.

<i>Support 24 hours a day, 7 days a week⁵</i>	
Canada	1-800-565-3344
Puerto Rico	1-800-426-7299
United States	1-800-426-7299

Appendix B. Product Warranty and Notices

The following warranty information applies to products purchased in the United States, Canada, and Puerto Rico.

The warranty terms and conditions applicable in the country of purchase are available from IBM or your reseller.

International Business Machines Corporation

Armonk, New York, 10504

Statement of Limited Warranty

The warranties provided by IBM in this Statement of Limited Warranty apply only to Machines you originally purchase for your use, and not for resale, from IBM or your reseller. The term "Machine" means an IBM machine, its features, conversions, upgrades, elements, or accessories, or any combination of them. Unless IBM specifies otherwise, the following warranties apply only in the country where you acquire the Machine. If you have any questions, contact IBM or your reseller.

Machine: External PCMCIA 4X CD-ROM Drive

Warranty Period*: One Year

**Contact your place of purchase for warranty service information.*

⁴ Response time will vary depending on the number and nature of calls received.

⁵ Support not available on certain holidays.

Production Status

Each Machine is manufactured from new parts, or new and used parts. In some cases, the Machine may not be new and may have been previously installed. Regardless of the Machine's production status, IBM's warranty terms apply.

The IBM Warranty for Machines

IBM warrants that each Machine 1) is free from defects in materials and workmanship and 2) conforms to IBM's Official Published Specifications. The warranty period for a Machine is a specified, fixed period commencing on its Date of Installation. The date on your receipt is the Date of Installation, unless IBM or your reseller informs you otherwise.

During the warranty period IBM or your reseller, if authorized by IBM, will provide warranty service under the type of service designated for the Machine and will manage and install engineering changes that apply to the Machine.

For IBM or your reseller to provide warranty service for a feature, conversion, or upgrade, IBM or your reseller may require that the Machine on which it is installed be 1) for certain Machines, the designated, serial-numbered Machine and 2) at an engineering-change level compatible with the feature, conversion, or upgrade. Many of these transactions involve the removal of parts and their return to IBM. You represent that all removed parts are genuine and unaltered. A part that replaces a removed part will assume the warranty service status of the replaced part.

If a Machine does not function as warranted during the warranty period, IBM or your reseller will repair it or replace it with one that is at least functionally equivalent, without charge. The replacement may not be new, but will be in good working order. If IBM or your reseller is unable to repair or replace the Machine, you may return it to your place of purchase and your money will be refunded.

If you transfer a Machine to another user, warranty service is available to that user for the remainder of the warranty period. You should give your proof of purchase and this Statement to that user. However, for Machines which have a life-time warranty, this warranty is not transferable.

Warranty Service

To obtain warranty service for the Machine, you should contact your reseller or call IBM. In the United States, call IBM at **1-800-426-7299**. In Canada, call IBM at **1-800-565-3344**. You may be required to present proof of purchase.

IBM or your reseller will provide certain types of repair and exchange service, either at your location or at IBM's or your reseller's service center, to restore a Machine to good working order.

When a type of service involves the exchange of a Machine or part, the item IBM or your reseller replaces becomes its property and the replacement becomes yours. You represent that all removed items are genuine and unaltered. The replacement may not be new, but will be in good working order and at least functionally equivalent to the item replaced. The replacement assumes the warranty service status of the replaced item. Before IBM or your reseller exchanges a Machine or part, you agree to remove all features, parts, options, alterations, and attachments not under warranty service. You also agree to ensure that the Machine is free of any legal obligations or restrictions that prevent its exchange.

You agree to:

1. obtain authorization from the owner to have IBM or your reseller service a Machine that you do not own; and
2. where applicable, before service is provided —
 - a. follow the problem determination, problem analysis, and service request procedures that IBM or your reseller provide,
 - b. secure all programs, data, and funds contained in a Machine, and
 - c. inform IBM or your reseller of changes in a Machine's location.

IBM is responsible for loss of, or damage to, your Machine while it is 1) in IBM's possession or 2) in transit in those cases where IBM is responsible for the transportation charges.

Extent of Warranty

IBM does not warrant uninterrupted or error-free operation of a Machine.

The warranties may be voided by misuse, accident, modification, unsuitable physical or operating environment, improper maintenance by you, removal or alteration of Machine or parts identification labels, or failure caused by a product for which IBM is not responsible.

THESE WARRANTIES REPLACE ALL OTHER WARRANTIES OR CONDITIONS, EXPRESS OR IMPLIED, INCLUDING, BUT NOT LIMITED TO, THE IMPLIED WARRANTIES OR CONDITIONS OF MERCHANTABILITY AND FITNESS FOR A PARTICULAR PURPOSE. THESE WARRANTIES GIVE YOU SPECIFIC LEGAL RIGHTS AND YOU MAY ALSO HAVE OTHER RIGHTS WHICH VARY FROM JURISDICTION TO JURISDICTION. SOME JURISDICTIONS DO NOT ALLOW THE EXCLUSION OR LIMITATION OF EXPRESS OR IMPLIED WARRANTIES, SO THE ABOVE EXCLUSION OR LIMITATION MAY NOT APPLY TO YOU. IN THAT EVENT SUCH WARRANTIES ARE LIMITED IN DURATION TO THE WARRANTY PERIOD. NO WARRANTIES APPLY AFTER THAT PERIOD.

Limitation of Liability

Circumstances may arise where, because of a default on IBM's part or other liability you are entitled to recover damages from IBM. In each such instance, regardless of the basis on which you are entitled to claim damages from IBM (including fundamental breach, negligence, misrepresentation, or other contract or tort claim), IBM is liable only for:

1. damages for bodily injury (including death) and damage to real property and tangible personal property; and
2. the amount of any other actual direct damages or loss, up to the greater of U.S. \$100,000 or the charges (if recurring, 12 months' charges apply) for the Machine that is the subject of the claim.

UNDER NO CIRCUMSTANCES IS IBM LIABLE FOR ANY OF THE FOLLOWING: 1) THIRD-PARTY CLAIMS AGAINST YOU FOR LOSSES OR DAMAGES (OTHER THAN THOSE UNDER THE FIRST ITEM LISTED ABOVE); 2) LOSS OF, OR DAMAGE TO, YOUR RECORDS OR DATA; OR 3) SPECIAL, INCIDENTAL, OR INDIRECT DAMAGES OR FOR ANY ECONOMIC CONSEQUENTIAL DAMAGES (INCLUDING LOST PROFITS OR SAVINGS), EVEN IF IBM OR YOUR RESELLER IS INFORMED OF THEIR POSSIBILITY. SOME JURISDICTIONS DO NOT ALLOW THE EXCLUSION OR LIMITATION OF INCIDENTAL OR CONSEQUENTIAL DAMAGES, SO THE ABOVE EXCLUSION OR LIMITATION MAY NOT APPLY TO YOU.

Notices

References in this publication to IBM products, programs, or services do not imply that IBM intends to make these available in all countries in which IBM operates. Any reference to an IBM product, program, or service is not intended to state or imply that only that IBM product, program, or service may be used. Subject to IBM's valid intellectual property or other legally protectable rights, any functionally equivalent product, program, or service may be used instead of the IBM product, program, or service. The evaluation and verification of operation in conjunction with other products, except those expressly designated by IBM, are the responsibility of the user.

IBM may have patents or pending patent applications covering subject matter in this document. The furnishing of this document does not give you any license to these patents. You can send license inquiries, in writing, to:

IBM Director of Licensing
IBM Corporation
500 Columbus Avenue
Thornwood, NY 10594
U.S.A.

Trademarks

The following terms are trademarks of the IBM Corporation in the United States or other countries or both:

IBM OS/2

The following terms are trademarks of other companies:

PCMCIA	Personal Computer Memory Card International Association
AMP	AMP Incorporated
MSCDEX	Microsoft Corporation

Microsoft and Windows are trademarks or registered trademarks of Microsoft Corporation.

Other company, product, and service names may be trademarks or service marks of others.

Laser Compliance Statement

Some IBM Personal Computer models are equipped from the factory with a CD-ROM drive. The CD-ROM drive is a laser product. The CD-ROM drive is certified in the U.S. to conform to the requirements of the Department of Health and Human Services 21 Code of Federal Regulations (DHHS 21 CFR) Subchapter J for Class 1 laser products. Elsewhere, the drive is certified to conform to the requirements of the Electrotechnical Commission (IEC) 825 and CENELEC EN 60 825 for Class 1 laser products.

Class 1 laser products are not considered to be hazardous.

Electronic Emission Notices

Federal Communications Commission (FCC) Statement

Note: This equipment has been tested and found to comply with the limits for a Class B digital device, pursuant to Part 15 of the FCC Rules. These limits are designed to provide reasonable protection against harmful interference in a residential installation. This equipment generates, uses, and can radiate radio frequency energy and, if not installed and used in accordance with the instructions, may cause harmful interference to radio communications. However, there is no guarantee that interference will not occur in a particular installation. If this equipment does cause harmful interference to radio or television reception, which can be determined by turning the equipment off and on, the user is encouraged to try to correct the interference by one or more of the following measures:

- Reorient or relocate the receiving antenna.
- Increase the separation between the equipment and receiver.
- Connect the equipment into an outlet on a circuit different from that to which the receiver is connected.

- Consult an IBM authorized dealer or service representative for help.

IBM is not responsible for any radio or television interference caused by unauthorized changes or modifications to this equipment. Unauthorized changes or modifications could void the user's authority to operate the equipment.

This device complies with Part 15 of the FCC Rules. Operation is subject to the following two conditions: (1) this device may not cause harmful interference, and (2) this device must accept any interference received, including interference that may cause undesired operation.

The following FCC statement applies to

Industry Canada Class B Emission Compliance Statement

This Class B digital apparatus meets the requirements of the Canadian Interference-Causing Equipment Regulations.

Avis de conformité à la réglementation d

Cet appareil numérique de la classe B respecte toutes les exigences du Règlement sur le matériel brouilleur du Canada.

Deutsche EMV-Direktive (electromagnetische Verträglichkeit)

Dieses Gerät ist berechtigt in Übereinstimmung mit dem deutschen EMVG vom 9.Nov.92 das EG-Konformitätszeichen zu führen.

Der Aussteller der Konformitätserklärung ist die IBM UK, Greenock.

Dieses Gerät erfüllt die Bedingungen der EN 55022 Klasse B.

European Union - EMC Directive

This product is in conformity with the protection requirements of EU Council Directive 89/366/ECC on the approximation of the laws of the Member States relating to electromagnetic compatibility.

IBM can not accept responsibility for any failure to satisfy the protection requirements resulting from a non-recommended modification of the product, including the fitting of non-IBM option cards.

This product has been tested and found to comply with the limits for Class B Information Technology Equipment according to CISPR 22 / European Standard EN 55022. The limits for Class B equipment were derived for typical residential environments to provide reasonable protection against interference with licensed communication devices.

Union Européenne - Directive Conformité électromagnétique

Ce produit est conforme aux exigences de protection de la Directive 89/336/EEC du Conseil de l'UE sur le rapprochement des lois des États membres en matière de compatibilité électromagnétique.

IBM ne peut accepter aucune responsabilité pour le manquement aux exigences de protection résultant d'une modification non recommandée du produit, y compris l'installation de cartes autres que les cartes IBM.

Ce produit a été testé et il satisfait les conditions de l'équipement informatique de Classe B en vertu de CISPR22 / Standard européen EN 55022. Les conditions pour l'équipement de Classe B ont été définies en fonction d'un contexte résidentiel ordinaire afin de fournir une protection raisonnable contre l'interférence d'appareils de communication autorisés.

Unione Europea - Direttiva EMC (Conformidad electromagnética)

Este producto satisface los requisitos de protección del Consejo de la UE, Directiva 89/336/CEE en lo que a la legislatura de los Estados Miembros sobre compatibilidad electromagnética se refiere.

IBM no puede aceptar responsabilidad alguna si este producto deja de satisfacer dichos requisitos de protección como resultado de una modificación no recomendada del producto, incluyendo el ajuste de tarjetas de opción que no sean IBM.

Este producto ha sido probado y satisface los límites para Equipos Informáticos Clase B de conformidad con el Estándar CISPR22 y el Estándar Europeo EN 55022. Los límites para los equipos de Clase B se han establecido para entornos residenciales típicos a fin de proporcionar una protección razonable contra las interferencias con dispositivos de comunicación licenciados.

Union Eurpea - Normativa EMC

Questo prodotto è conforme alle normative di protezione ai sensi della Direttiva del Consiglio dell'Unione Europea 89/336/CEE sull'armonizzazione legislativa degli stati membri in materia di compatibilità elettromagnetica.

IBM non accetta responsabilità alcuna per la mancata conformità alle normative di protezione dovuta a modifiche non consigliate al prodotto, compresa l'installazione di schede e componenti di marca diversa da IBM.

Le prove effettuate sul presente prodotto hanno accertato che esso rientra nei limiti stabiliti per le apparecchiature di informatica Classe B ai sensi del CISPR 22 / Norma Europea EN 55022. I limiti delle apparecchiature della Classe B sono stati stabiliti al fine di fornire ragionevole protezione da interferenze mediante dispositivi di comunicazione in concessione in ambienti residenziali tipici.



Part Number: 52H3387

Printed in U.S.A.

52H3387

