

IBM 48X/32X/48X/16X Max CD-RW/DVD-ROM  
组合驱动器



# 用户指南



IBM 48X/32X/48X/16X Max CD-RW/DVD-ROM  
组合驱动器



# 用户指南

注：在使用本资料及其支持的产品之前，请阅读第 F-1 页的附录 F, 『IBM Statement of Limited Warranty - Z125-4753-07 - 11/2002』和第 G-1 页的附录 G, 『Notices』下的信息。对本手册所包含的内容，IBM 公司拥有最终解释权，如有变更，恕不另行通知。

---

## 安全：请先阅读

Before installing this product, read the Safety Information.

مج، يجب قراءة دات السلامة

Antes de instalar este produto, leia as Informações de Segurança.

在安装本产品之前，请仔细阅读 **Safety Information**  
(安全信息)。

Prije instalacije ovog produkta obavezno pročitajte Sigurnosne Upute.

Před instalací tohoto produktu si přečtěte příručku bezpečnostních instrukcí.

Læs sikkerhedsforskrifterne, før du installerer dette produkt.

Ennen kuin asennat tämän tuotteen, lue turvaohjeet kohdasta Safety Information.

Avant d'installer ce produit, lisez les consignes de sécurité.

Vor der Installation dieses Produkts die Sicherheitshinweise lesen.

Πριν εγκαταστήσετε το προϊόν αυτό, διαβάστε τις πληροφορίες ασφάλειας  
(safety information).

לפני שתתקינו מוצר זה, קראו את הוראות הבטיחות.

A termék telepítése előtt olvassa el a Biztonsági előírásokat!

Prima di installare questo prodotto, leggere le Informazioni sulla Sicurezza.

製品の設置の前に、安全情報をお読みください。

본 제품을 설치하기 전에 안전 정보를 읽으십시오.

Пред да се инсталира овој продукт, прочитајте информацијата за безбедност.

Lees voordat u dit product installeert eerst de veiligheidsvoorschriften.

Les sikkerhetsinformasjonen (Safety Information) før du installerer dette produktet.

Przed zainstalowaniem tego produktu, należy zapoznać się  
z książką "Informacje dotyczące bezpieczeństwa" (Safety Information).

Antes de instalar este produto, leia as Informações sobre Segurança.

Перед установкой продукта прочтите инструкции по  
технике безопасности.

Pred inštaláciou tohto zariadenia si pečítajte Bezpečnostné predpisy.

Pred namestitvijo tega proizvoda preberite Varnostne informacije.

Antes de instalar este producto lea la información de seguridad.

Läs säkerhetsinformationen innan du installerar den här produkten.

安裝本產品之前，請先閱讀「安全資訊」。

---

## 一般安全准则

请始终遵守以下预防措施以降低人身伤害和财产损失的风险。

### 维修

请勿试图自己维修产品，除非 IBM Support 指示您这样操作。请仅允许经 IBM 授权和批准的维修人员维修您的产品。

注：某些部件可由客户升级或更换。这些部件被称为“客户可更换部件”或 CRU。IBM 明确地标明了这些 CRU，并提供了文档，文档中含有客户何时可以更换这些部件的说明。进行此类更换时，您必须严格按照所有说明进行操作。在您尝试更换前，请始终确保电源关闭，并且已经从所有电源拔出产品的电源插头。如果您有任何问题或疑问，请联系 IBM 支持中心。

### 电源线和电源适配器

请仅使用产品制造商提供的电源线和电源适配器。

切勿将电源线缠绕在电源适配器或其它物体上。环绕电源线会绷紧电源线从而导致电源线磨损、破裂或弯曲。这会引起安全隐患。

始终沿特定线路布置电源线以避免遭践踏、绊倒他人或被物体夹紧。

避免电源线和电源适配器接触到液体。例如，切勿将电源线或电源适配器放在水槽、水盆、盥洗室附近，或放在用液体清洗剂清洁过的地板上。液体会导致短路，尤其是因误用而绷紧电源线或施压于电源适配器时。液体还会引起电源线终端和 / 或适配器上的连接器终端逐渐腐蚀，最终导致适配器过热。

始终以正确的顺序连接电源线和信号电缆，并确保所有的电源线连接器都牢固而完全地插入在插座中。

请勿使用交流电源输入引脚处出现腐蚀迹象和 / 或交流电源输入处或其它地方出现过热迹象（例如变形的塑料）的电源适配器。

请勿使用任何一端的电气触点出现腐蚀或过热迹象的电源线，也不要使用出现任何损坏现象的电源线。

## 延长线和相关设备

确保您使用的延长线、电涌保护器、不间断电源和电源拖板的额定值符合产品的电气要求。请勿使这些设备过载。如果使用电源拖板，负载不应该超出电源拖板的输入额定值。如果您对于电源负载、电源要求和输入额定值有疑问，请咨询电工获取更多信息。

## 插头和插座

如果您想要用于计算机设备的插座（电源插座）出现损坏或腐蚀的情况，请勿使用该插座，直至有资格的电工将其更换。

请勿弯曲或改装电源插头。如果电源插头损坏，请与制造商联系以获得替代品。

某些产品装配有三线插头。该插头仅适合插入接地的电源插座。这是一种安全装置。请勿通过尝试将其插入非接地插座弄坏这种安全装置。如果您无法将插头插入插座，则联系电工以获取核准的插座适配器或用支持该安全装置的插座替换该插座。请勿使电源插座过载。整个系统负载不应该超出分支电路额定值的 80%。如果您对于电源负载和分支电路额定值有疑问，请咨询电工以获取更多信息。

请确保您使用的电源插座正确连接、使用方便并紧靠设备放置。完全展开电源线时请勿使其紧绷。

请小心地将设备连接到电源插座和从电源插座断开连接。

## 电池

全部 IBM 个人计算机都包含不可充电的纽扣电池为系统时钟提供电源。另外，许多移动式产品（例如 ThinkPad 笔记本 PC）利用充电电池在便携方式下提供系统电源。IBM 提供的用于产品的电池已经过兼容性测试，并且只可用 IBM 批准的部件进行更换。

请勿尝试打开或维修任何电池。请勿压碎、刺穿或焚烧电池或使金属触点短路。请勿将电池与水或其它液体接触。只能严格根据产品文档中所包含的说明对电池进行充电。

滥用或不正确处理电池会引起电池过热，而过热会导致电池或纽扣电池释放气体或发出火焰。若电池已经损坏或者发现有物质从电池中流出或电池引线上有异物堆积，请停止使用该电池，并从电池制造商处获取新电池。

电池长期闲置不用后，其性能会下降。对于某些可充电电池（尤其是锂离子电池），将其以放电状态闲置可能会增加发生电路短路的风险，这样会缩短电池寿命，也会引起安全隐患。请勿将可充电锂离子电池完全放电，或将这些电池以放电状态存储。

## 产品散热与通风

当计算机开启和电池充电时，计算机会发热。由于外型轻巧紧凑，因此笔记本 PC 会产生很大的热量。请始终遵循以下基本预防措施：

- 当计算机运行或电池充电时，请避免使计算机底部与腿部或身体任何部分的接触时间过长。计算机在正常操作过程中会产生一些热量。与身体长时间的接触会导致不适甚至可能灼伤皮肤。
- 请勿在易燃物质附近或易爆环境中操作计算机或对电池充电。

- 为了安全、舒适和可靠地操作产品，随产品一起提供了通风槽、风扇和 / 或散热器。将产品放在床、沙发、地毯或其它柔性物体表面上有可能无意中会妨碍这些功能部件的运行。切勿阻塞、覆盖或禁用这些功能部件。

## CD 和 DVD 驱动器安全

CD 和 DVD 驱动器以高速度旋转光盘。如果 CD 或 DVD 破裂或有其它物理损坏，则在使用 CD 驱动器时光盘可能断裂或者甚至粉碎。要避免因这种情况造成伤害的可能性并且减少损坏您机器的危险，请执行以下操作：

- 始终将 CD/DVD 光盘存放在它们的原始包装中
- 存放 CD/DVD 光盘时，始终确保避免阳光直射并且远离直接热源
- 不使用时，从计算机中取出 CD/DVD 光盘
- 请勿弯曲 CD/DVD 光盘或将它们强行放入计算机或它们的包装
- 使用每张光盘前，请检查 CD/DVD 光盘是否有破裂。请勿使用破裂或损坏的光盘



# 目录

安全：请先阅读 . . . . .	iii	制作可引导 CD 或 DVD . . . . .	1-9
一般安全准则 . . . . .	iv	关于 CD 和 DVD 映像 . . . . .	1-10
维修 . . . . .	iv	观看 DVD 电影 . . . . .	1-10
电源线和电源适配器 . . . . .	iv	DVD 区域代码 . . . . .	1-10
延长线和相关设备 . . . . .	v	保养和维护 . . . . .	1-10
插头和插座 . . . . .	v	CD 安全信息 . . . . .	1-11
电池 . . . . .	v	保养 CD 或 DVD . . . . .	1-11
产品散热与通风 . . . . .	v	保养 CD-RW/DVD-ROM 组合驱动器 . . . . .	1-11
CD 和 DVD 驱动器安全 . . . . .	vi	手动弹出光盘 . . . . .	1-12
关于本书 . . . . .	ix	附录 A. 产品规格 . . . . .	A-1
注册选件 . . . . .	ix	附录 B. 问题解决 . . . . .	B-1
安装与用户指南 . . . . .	1-1	附录 C. 定制设备驱动程序配置设置 . . . . .	C-1
产品描述 . . . . .	1-1	对 Windows Me 启用 DMA . . . . .	C-1
软件描述 . . . . .	1-1	启用 Windows 2000 的 DMA . . . . .	C-1
安装要求 . . . . .	1-2	对 Windows XP 启用 DMA . . . . .	C-2
开始前 . . . . .	1-2		
操作预防措施 . . . . .	1-2	附录 D. 启用数字音频抽取 . . . . .	D-1
驱动器控件和接口 . . . . .	1-2		
安装驱动器 . . . . .	1-3	附录 E. 服务与支持 . . . . .	E-1
步骤 1. 打开计算机 . . . . .	1-3	联机技术支持 . . . . .	E-1
步骤 2. 除去驱动器的包装 . . . . .	1-4	电话技术支持 . . . . .	E-1
步骤 3. 设置配置跳线 . . . . .	1-4		
步骤 4. 选择 IDE 接口 . . . . .	1-5	附录 F. IBM Statement of Limited	
步骤 5. 将驱动器安装在托架中 . . . . .	1-5	Warranty - Z125-4753-07 - 11/2002 . . . . .	F-1
步骤 6. 将电缆连接到驱动器 . . . . .	1-5	Part 2 - Country-unique Terms . . . . .	F-4
步骤 7. 完成硬件安装 . . . . .	1-6	Part 3 - Warranty Information . . . . .	F-16
步骤 8. 更新计算机配置 . . . . .	1-6		
步骤 9. 安装 CD-RW 和 DVD 软件 . . . . .	1-6	附录 G. Notices . . . . .	G-1
步骤 10. 设置计算机用于 DVD 视频回放 . . . . .	1-7	Federal Communications Commission (FCC) statement . . . . .	G-1
步骤 11. 设置系统用于 CD 回放 . . . . .	1-7	Trademarks . . . . .	G-4
使用 CD-R 和 CD-RW 光盘 . . . . .	1-7	Electronic emission notices . . . . .	G-4
格式化 CD . . . . .	1-9	Federal Communications Commission (FCC)	
使用 RecordNow 软件 . . . . .	1-9	statement . . . . .	G-4
RecordNow 项目 . . . . .	1-9		



---

## 关于本书

本手册包含安装和使用 IBM<sup>®</sup> 48X/32X/48X/16X Max CD-RW/DVD-ROM 组合驱动器的说明。本手册分为以下几个部分：

第一部分：安装和用户指南

本指南包含用以下几种语言版本的产品描述和安装说明：

- 巴西葡萄牙语
- 捷克语
- 英语
- 法语
- 德语
- 意大利语
- 日语
- 简体中文
- 斯洛伐克语
- 西班牙语
- 繁体中文
- 土耳其语

第二部分：附录

本部分包含设备驱动程序、问题解决、保修与支持信息以及声明信息

注：本手册中的插图可能与您的硬件稍微有些不同。

---

## 注册选件

感谢您购买该 IBM 产品。请花点时间注册您的产品，并向我们提供有助于 IBM 将来更好地为您服务的信息。您的反馈对于我们在开发对您相当重要的产品和服务，以及寻找更好的方式以便与您沟通方面具有重要价值。请在以下 IBM Web 站点中注册您的产品：

<http://www.ibm.com/pc/register>

IBM 将向您发送有关您所注册的产品信息和更新，除非您在 Web 站点的调查表中表明您不希望接收进一步的信息。



---

## 安装与用户指南

本部分包含 IBM 48X/32X/48X/16X Max CD-RW/DVD-ROM 组合驱动器的产品描述、硬件和软件安装说明以及操作信息。

---

### 产品描述

本产品包含一个可以读写 CD-R 和 CD-RW 光盘，也可以读 CD-ROM、DVD-ROM、DVD-RAM、DVD-RW 和 DVD-R 光盘的独特的多功能驱动器。本工具包还包括一张 CD，其中含有“联机用户指南”、DVD 回放软件和适用于 Microsoft® Windows® 2000 Professional、Microsoft Windows Millennium Edition (Me)、Microsoft Windows XP Home 和 Microsoft Windows XP Professional 的 CD 刻录软件。

选件包中包含以下物品：

- 一个 IBM 48X/32X/48X/16X Max CD-RW/DVD-ROM 组合驱动器
- 一包安装螺钉（4 个 M3 x 5-mm 螺钉，已开槽）
- 一根 18 英寸的 IDE 电缆
- 一张 IBM CD-RW/DVD-ROM 组合驱动器软件 and 用户指南 CD
- 一本《快速安装指南》

如果某一物品缺少或损坏，请与购买处联系。务必保留购货凭证；可能需要它来接受保修服务。有关技术支持信息，请参阅第 F-1 页的附录 F，『IBM Statement of Limited Warranty - Z125-4753-07 - 11/2002』。

该驱动器可以读许多 DVD 和 CD 格式，包括 DVD 视频、VCD 和音频 CD 格式。它还能写大多数 CD-RW 可重写和 CD-R 可刻录格式，包括高速 CD-R 介质。您必须安装所包含的 DVD 回放软件来播放 DVD 视频，同时必须安装所包含的 CD 刻录软件来写 CD-R 和 CD-RW 光盘。该驱动器还能读多段、扩展体系结构 (CD-XA) 光盘和 Kodak Photo CD。本驱动器能以高达 48 倍 (48X) 于 CD-ROM 和 CD-R 介质的标准 CD-ROM 驱动器速度来传送数据。本驱动器能以高达 16 倍 (16X) 于 DVD 介质的标准 DVD-ROM 驱动器速度来传送数据。该驱动器能读大多数 DVD-RAM、DVD-RW 和 DVD-R 介质类型，并符合 DVD-Multi Player 兼容性规范。该驱动器设计为适用于安装在使用集成驱动电子设备 (IDE) 或增强型 IDE (EIDE) 体系结构的个人计算机中。

---

### 软件描述

用户指南和软件 CD 包含以下软件：

- **IBM RecordNow**：通过 RecordNow，可以用多种方式刻录您自己的 CD。可以使用 CD 复制器功能来制作 CD 的备份副本，或者可以从硬盘驱动器上的文件制作数据 CD。也可以从 MP3 文件或其它音频 CD 创建音频 CD。RecordNow 还使您能将光盘映像保存到硬盘驱动器，并在以后将那些映像刻录成 CD。还可以使用 RecordNow 创建可引导 CD。

- **IBM Drive Letter Access (DLA)** : 您可以使用 DLA 通过驱动器盘符来访问 CD-RW 驱动器。可以使用 Windows 命令行或使用拖放方法将文件复制到可刻录的介质。
- **UDF Reader** : 您可以使用 UDF Reader 在其它计算机中读取通过 DLA 写的 CD。

---

## 安装要求

在安装驱动器之前，请确保计算机满足以下系统要求：

- 最低处理器要求：
  - Intel® Pentium® 133 MHz
  - Intel Pentium II 233 MHz 用于 DVD 回放
- 最小 RAM : 32 MB
- Windows 2000、Windows Me、Windows XP Home 或 Windows XP Professional 操作系统
- 可用的半高驱动器托架
- 可用的 IDE 连接
- 40 MB 可用硬盘驱动器空间
- 700 MB 可用硬盘驱动器空间（用于 CD 复制功能）
- 支持 44.1 或 48 kHz 采样速率的音频解决方案
- 可选立体声扬声器
- 2X AGP 视频，并且支持 DVD 回放

---

## 开始前

在安装 CD-RW/DVD-ROM 组合驱动器之前，请阅读本部分中有关操作预防措施以及有关使用驱动器控件和接口的信息。

---

## 操作预防措施

请采用以下操作预防措施来保护您的驱动器：

- 在准备好安装 CD-RW/DVD-ROM 组合驱动器之前，将其保存在防静电袋中。安装时尽量不要移动；移动会使静电累积起来。
- 小心操作驱动器。跌落或震动驱动器可能会损坏驱动器外壳内的组件。
- 请勿强行插入 IDE 电缆或电源线。这样做可能会损坏接口或驱动器。

---

## 驱动器控件和接口

下图显示了驱动器控件和接口的位置和功能。

驱动器前视图：

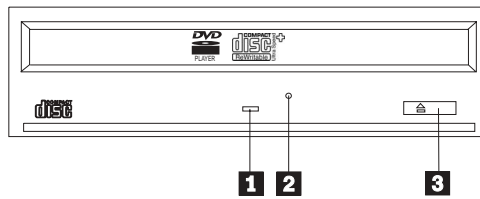

**1** 忙指示灯

当驱动器从光盘读取或写入光盘时，该指示灯亮起。

**2** 紧急弹出孔

该孔使用户能够使用弹出装置将光盘从驱动器中取出。

**3** 打开 / 关闭按钮

按此按钮时可打开和关闭光盘托盘。

驱动器后视图

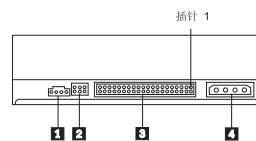

**1** 音频输出接口

该接口将模拟音频信号传送至音频适配器。

**2** 配置插针

这些插针用于设置驱动器配置。

**3** IDE 接口

该接口将 CD-RW/DVD-ROM 组合驱动器连接到 IDE 电缆。

**4** 电源接口

该接口将 CD-RW/DVD-ROM 组合驱动器连接到电源线。

---

## 安装驱动器

请按照以下步骤来安装 CD-RW/DVD-ROM 组合驱动器：

### 步骤 1. 打开计算机

1. 关闭计算机和所有连接的设备。
2. 从计算机和所有连接的设备上拔下所有电源线。
3. 从计算机上卸下外盖。有关卸下计算机外盖的说明，请参考计算机文档。

## 步骤 2. 除去驱动器的包装

1. 在打开包装驱动器的防静电袋之前，让袋子与未上漆的金属表面接触至少两秒钟。这样可排尽包装和您身上的静电。
2. 从袋子中取出驱动器。

如果必须放下驱动器，请将防静电袋放在垫平的表面（比如杂志）上，再将驱动器放在防静电袋上。

## 步骤 3. 设置配置跳线

如图所示，通过在配置插针上安插跳线，可将您的驱动器设置为主 **1**、从 **2** 或电缆选择 **3**。

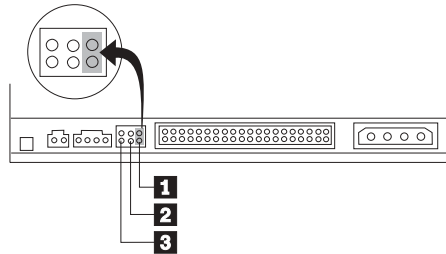

请使用以下准则来确定 CD-RW/DVD-ROM 组合驱动器的正确配置。

- 如果 CD-RW/DVD-ROM 组合驱动器是与 IDE 电缆连接的唯一设备，请将该驱动器配置为主设备。这是预配置。
- 如果 CD-RW/DVD-ROM 组合驱动器将是 IDE 电缆上的第二个设备，请将该驱动器配置为从设备。请务必将另一个设备配置为主设备。在某些情况下，当同一电缆上的另一个设备配置为从设备时，硬盘驱动器可能需要“存在从设备情况下的主设备”跳线设置。有关在其它设备上设置配置跳线的更多信息，请参考计算机随附的文档。
- 一些非 IBM 计算机使用特殊的 ATA 电缆，该电缆的两根电线反接在设备接口中，使得可通过电缆而非跳线位置来配置驱动器。请仅对配备了这些特殊电缆的计算机使用电缆选择位置。请参阅计算机随附的文档，以确定您的 ATA 适配器是否需要将跳线置于电缆选择位置。

如果将跳线置于电缆选择位置，IDE 电缆会根据电缆上驱动器的位置自动指定主设置和从设置。无论 CD-RW/DVD-ROM 组合驱动器是电缆上连接的唯一设备还是第二个设备，都必须对该布线系统使用电缆选择设置。最靠近 IDE 控制器的驱动器会自动成为主驱动器。IDE 电缆上的任何其它设备也须设置为电缆选择。



## 步骤 4. 选择 IDE 接口

较新的计算机通常有两个 IDE 接口。如果您的计算机有两个 IDE 接口，请使用第二个 IDE 接口来连接 CD-RW/DVD-ROM 组合驱动器。第二个 IDE 接口通常与连接到硬盘驱动器的主 IDE 接口相邻。所选择的 IDE 接口和电缆位置将决定要对驱动器使用哪一种配置跳线设置。

- 如果有两个 IDE 接口，请将 CD-RW/DVD-ROM 组合驱动器用驱动器随附的 IDE 电缆连接到第二个 IDE 接口。如果 CD-RW/DVD-ROM 组合驱动器是第二个 IDE 接口上唯一的设备，则使用主配置设置。如果第二个接口上除了 CD-RW/DVD-ROM 组合驱动器之外还有另一个设备，则使用从配置设置。
- 如果必须将 CD-RW/DVD-ROM 组合驱动器连接到与较快的设备（比如硬盘驱动器）相同的 IDE 接口，请对 CD-RW/DVD-ROM 组合驱动器使用从设置，而对较快的设备使用主设置。在某些实例中，当同一电缆上的另一个设备配置为从时，硬盘驱动器可能需要存在从设备之下的主设备设置。有关在其它设备上设置配置跳线的进一步信息，请参考计算机或所述设备随附的文档。
- 一些非 IBM 计算机支持电缆选择设置，其中设备在电缆上的位置决定了设备是主设备还是从设备。请参阅计算机随附的文档以确定系统是否支持此设置。

## 步骤 5. 将驱动器安装在托架中

**警告：** 当您直接将螺钉拧进驱动器时，请务必使用选件包中的安装螺钉。使用过长的螺钉可能会损坏驱动器。

可将 CD-RW/DVD-ROM 组合驱动器水平或垂直安装在计算机中。如果垂直安装 CD-RW/DVD-ROM 组合驱动器，则必须在关闭驱动器托盘之前固定好放入驱动器的任何光盘，否则该驱动器将不能正确读光盘。

1. 将驱动器滑入托架中。您的计算机可能对安装存储设备有特定要求的过程。有关存储设备的更多信息，请参考计算机随附的文档。
2. 将驱动器托架的螺钉孔对准驱动器外壳或安装支架的螺纹孔。
3. 请先不要旋紧螺钉，以检查它们的位置。通常，每一侧使用两个螺钉。验证是否已对准；然后拧紧螺钉以固定驱动器。请勿拧得过紧。

## 步骤 6. 将电缆连接到驱动器

下图显示了电缆连接到驱动器的位置。

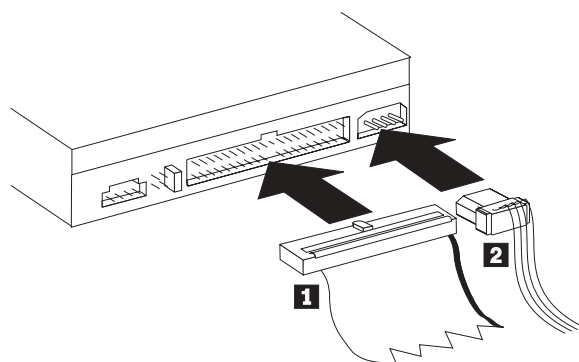

1. 将 40 针 IDE 电缆接口 **1** 连接到驱动器上的 IDE 接口。对齐电缆，将有颜色的一侧靠近电源线接口 **2**。如果没有电缆连接到 IDE 端口、如果计算机 IDE 电缆上只有一个设备接口或者如果计算机中的现有电缆是低速 40 线类型，请使用该选件

随附的 80 线高速 IDE 电缆。IDE 电缆最多可有三个接口。当要在 IDE 电缆上仅连接一个设备时，为获得最佳信号质量，请将此电缆的一端连接到 IDE 接口，并将电缆的另一端连接到设备上。请勿使用中间接口。

如果要将两个设备连接到 IDE 电缆上，请将电缆的一端连接到 IDE 接口，并将主设备和从属设备连接到另一端的其余接口。许多计算机具有两根电缆，用于连接最多四个 ATA 设备。为获得最佳性能，请将快速设备（比如硬盘驱动器）连接到与主 IDE 接口连接的电缆上，并将 CD-RW/DVD-ROM 组合驱动器或其它速度较慢的设备（比如 CD-ROM 驱动器、磁带机和可移动介质）连接到与第二个 IDE 接口连接的电缆上。

2. 将四针电源线 **2** 连接到 CD-RW/DVD-ROM 组合驱动器的电源接口。

确保电缆不会受到计算机外盖的挤压，且所有其它电缆和电源连接都是安全可靠的。

## 步骤 7. 完成硬件安装

1. 确保 CD-RW/DVD-ROM 组合驱动器已牢固安装，并且各接口已紧密连接。
2. 确保电缆不妨碍计算机外盖，且未阻塞电源风扇叶片或气流通路。
3. 重新安装计算机外盖。
4. 重新连接所有外接设备。
5. 将所有电源线插入电源插座。

## 步骤 8. 更新计算机配置

完成硬件安装后，请重新启动计算机。通常，开启计算机时，显示配置设置信息屏幕。如果没有看见此屏幕，请查看您的计算机文档获取有关访问配置或设置实用程序的信息。

要查看大多数 IBM 计算机的配置信息，请在启动过程中屏幕右上角显示 IBM 图形时按 F1。完成信息浏览后，请保存更改并退出。

## 步骤 9. 安装 CD-RW 和 DVD 软件

您必须安装三种软件应用程序，以便使用该驱动器的 CD-RW 和 DVD 视频功能。所有这些软件都包含在 *IBM CD-RW/ DVD-ROM 软件和用户指南 CD* 上。

*IBM CD-RW/DVD-ROM 软件和用户指南 CD* 包含以下软件应用程序：

- Intervideo WinDVD，用来支持 DVD 视频回放
- IBM RecordNow，用来支持传统 CD 制作
- IBM Drive Letter Access (DLA)，用来支持拖放式 CD 刻录
- UDF Reader 软件，用于在其它计算机中读 DLA 光盘

Windows XP 内置了拖放支持。该功能不需要其它软件即可与您的驱动器一起工作。如果安装 DLA，则操作系统内置的支持便由 DLA 功能取代，但可从驱动器盘符的属性菜单中启用。

要安装这些应用程序，请执行以下步骤：

1. 将 *IBM CD-RW/DVD-ROM 软件*和*用户指南 CD* 插入 CD-RW/DVD-ROM 组合驱动器。浏览器自动启动。
2. 在浏览器中单击 **RecordNow**，单击 **Drive Letter Access**，然后单击 **WinDVD**。
3. 重新启动计算机。
4. 如果浏览器不启动，请打开命令窗口，对每个应用程序输入以下内容，其中 e 是 CD-RW/DVD 组合驱动器的驱动器盘符：  
e:\launch.bat

## 步骤 10. 设置计算机用于 DVD 视频回放

本部分提供有关启用 DMA 设置的说明，这样您可以通过 CD-RW/DVD-ROM 组合驱动器来播放 DVD 电影。

1. 在桌面上或“开始”菜单中右键单击我的电脑。
2. 从弹出菜单中选择“属性”。
3. 检查操作系统，然后按照第 C-1 页的附录 C，『定制设备驱动程序配置设置』中包含的启用 DMA 的适当说明进行操作。
  - 如果操作系统是 Windows Me，请按照第 C-1 页的『对 Windows Me 启用 DMA』中的说明进行操作。
  - 如果操作系统是 Windows 2000，请按照第 C-1 页的『启用 Windows 2000 的 DMA』中的说明进行操作。
  - 如果操作系统是 Windows XP，请按照第 C-2 页的『对 Windows XP 启用 DMA』中的说明进行操作。

## 步骤 11. 设置系统用于 CD 回放

为了在驱动器上播放音频 CD，必须启用数字回放。数字回放使用 IDE 数据电缆将音频数据从驱动器发送到计算机而不是使用模拟音频电缆。这样通常会得到更好的回放质量，但代价是计算机需要消耗稍多一些的资源将数字数据转换为模拟音频。要收听 CD 音频，有两个部分需要设置：配置驱动器和配置回放应用程序。

### 配置驱动器以用于数字回放

如果具有 Windows XP，则驱动器应该自动配置为数字回放。

如果具有 Windows 2000 或 Windows Me，则将需要将系统配置为使用数字回放。有关如何启用数字抽取的循序渐进的过程，请参考附录 D 中的说明。

### 配置回放应用程序以用于数字回放

要在系统上进行 CD 音频的数字回放，您还必须配置 CD 回放应用程序。如果希望将 Windows Media Player 用作回放应用程序，请按照附录 D 中的说明来启用 Windows Media Player 中的该功能。如果有第三方 CD 播放器应用程序，请参考该应用程序的文档来获取详细信息。

---

## 使用 CD-R 和 CD-RW 光盘

CD-RW/DVD-ROM 组合驱动器还可以写入 CD-R 和 CD-RW 光盘。CD-RW 光盘可以擦除和重新使用多次；CD-R 光盘只可写一次。









RecordNow 用于复制 CD，创建新的数据 CD 以及制作可由标准 CD-RW 驱动器和 CD 播放器读取的新的音频 CD。RecordNow 也可以用来创建 ISO9660 格式的 CD 映像并将以前保存的映像刻录成 CD。

DLA 用于制作可以修改多次的文件归档和数据 CD。它还提供了直接访问盘符这个便利功能。当与 CD-RW 介质一起使用时，DLA 与使用软盘存储文件非常相似。如果 DLA 与 CD-R 介质一起使用，则在 CD 写满之前可进行写入和重写，然后数据便固定下来。DLA 创建的介质只能用支持多重读取方式的较新 CD-ROM 驱动器和 DVD-ROM 驱动器来读取。

当使用其它计算机读取未终结的 DLA 介质时，可能需要 UDF Reader。请将提供的 UDF Reader 安装在其它需要读光盘的系统上，而不是安装在您的系统上。

CD-R 光盘在音频 CD 播放器上是可播放的。CD-RW 光盘在大多数音频 CD 播放器中不可播放。

CD-RW 介质具有 4 种不同的类型：多速、高速、超高速和超高速+。多速介质通常指定为 2X 或 2X-4X。高速介质常常列为 4X-10X 或 4X-12X 并带有高速徽标。超高速介质通常列为 16X-24X 并带有超高速徽标。超高速+介质通常列为 16X-32X 并带有超高速+徽标。您的 CD-RW 可以写入所有 4 种类型的 CD-RW 介质。如果您使用高速或超高速或超高速+ CD-RW 介质，则具有较低速度 CD-RW 驱动器的计算机无法将数据添加到此介质中。下表显示了不同介质在不同驱动器中的兼容性，以及各驱动器和介质上的徽标。

	驱动器类型			
				
介质类型：  2X - 4X 介质	读 写	读 写	读 写	读 写
 4X - 12X 介质	读	读 写	读 写	读 写
 16X - 24X 介质	读	读	读 写	读 写
 16X - 32X 介质	读	读	读	读 写

## 格式化 CD

要使用 DLA 拖放文件，您必须首先格式化空白的 CD-R 或 CD-RW 光盘。

要用 DLA 程序格式化 CD-R 或 CD-RW 光盘：

1. 插入空白光盘。
2. 双击我的电脑。
3. 右键单击 **CD-RW** 图标。
4. 单击格式化。
5. 在 Volume Label 窗口中输入光盘的标题。光盘名称最多可有 11 字符。
6. 如果想要使用 EasyWrite 进行后台格式化，请选中 **EasyWrite** 复选框。
7. 单击 **Start** 以开始光盘格式化，格式化完成时请单击 **OK**。
8. 当格式化完成框出现时单击 **OK**。现在可将信息写入光盘了。

注：正常的格式化将花费 4 到 45 分钟，这取决于介质的速度。EasyWrite 格式化将花费不到 2 分钟，但是如果 CD 弹出或计算机关闭，则需花费额外的时间。

注：在格式化光盘的同时可以在计算机上执行其它任务。

---

## 使用 RecordNow 软件

RecordNow 允许您刻录 DVD、音频 CD、数据 CD 并且复制现有光盘。它还允许您将映像保存到硬盘并且从先前创建的映像烧录。有关使用 RecordNow 的详细信息包含在 RecordNow 帮助中。可以通过按 RecordNow 菜单中的 F1 来访问 RecordNow 帮助。

要在 Windows Me 或 Windows 2000 中启动 RecordNow，请选择开始 → 程序 → **IBM RecordNow**。

## RecordNow 项目

一旦 RecordNow 启动，就可以选择具有不同功能的 3 个选项卡。

Audio Project 选项卡允许您创建音频 CD、MP3 Jukebox 磁盘或者收听音频 CD 或制作 CD 标签。

Data Project 选项卡允许您制作数据光盘、制作精确副本、擦除可重写光盘或制作 CD 或 DVD 标签。

Backup Project 菜单允许您对文件进行归档、制作精确副本、保存 CD 或 DVD 的映像、将保存的映像烧录到磁盘或制作磁盘标签。

对于可追加的 CD 和 DVD 项目，选中该项目后，RecordNow 将从驱动器中 CD 或 DVD 上的任何数据。

## 制作可引导 CD 或 DVD

要制作可引导 CD 或 DVD，请打开数据项目并且按项目窗口右上角的可引导 CD 按钮。将提示您从硬盘选择引导映像或从软盘制作引导映像。

## 关于 CD 和 DVD 映像

RecordNow 可以保存和创建 ISO 和 GI 类型的 CD 映像。ISO 映像只能用于保存只有一个数据会话的数据 CD。必须使用 GI 格式保存音频 CD、DVD、多会话 CD 和混合类型的 CD。

---

## 观看 DVD 电影

在安装 CD-RW/DVD-ROM 组合驱动器、配置 DMA 和安装 DVD 观看软件后，您可以观看 DVD 电影。

当插入 DVD 时，WinDVD 将自动启动。如果想手工启动 WinDVD，请按以下说明操作：

1. 单击开始，单击程序，然后单击 **Intervideo WinDVD**。
2. 单击 **Intervideo WinDVD**。

DVD 电影播放器窗口打开。有关如何使用 DVD 电影播放器的更多信息，请按 F1 参考 WinDVD 联机帮助。

## DVD 区域代码

区域代码有助于防止未经授权而复制 DVD 内容。全球分为六个区域，MPEG-2 解码软件包含与驱动器要使用的区域相应的区域代码设置。通常，每张 DVD 制造时都带有区域代码设置，使得它只能在具有相同区域代码设置的 DVD 驱动器中观看。DVD 的区域代码设置由包装背面的区域代码符号指示。下表列出了六个区域代码及其相应的区域代码符号。

区域代码	区域
1	美国、加拿大
2	欧洲、中东、南非、日本
3	东南亚、台湾、韩国
4	拉丁美洲、澳大利亚、新西兰
5	前苏联、非洲其它地区、印度
6	中华人民共和国

系统会提示您进行初始区域选择。如果插入的 DVD 具有不同于初始区域代码的区域代码，则 WinDVD 将询问是否要更改区域代码设置。在设置初始区域代码后，从初始设置开始最多可更改区域代码四次。从初始设置开始更改区域代码四次后，它便固定下来，不能再做更改。要更改区域代码，必须有一张具有新的区域代码设置的 DVD。

要显示区域代码状态，请按照以下说明进行操作：

1. 在 WinDVD 窗口中单击 **DVD** 选项。
2. 单击 **DVD** 区域。

---

## 保养和维护

本部分包含有关保养 CD-RW/DVD-ROM 组合驱动器以及与该驱动器一起使用的 CD 和 DVD 的信息。

## CD 安全信息

小心地处理和清洁光盘，特别是可写的介质类型，例如 CD-R 和 CD-RW 光盘，以便使它们保持可读。通过使用以下预防措施可以延长光盘寿命：

- 请始终将光盘存储在其原始包装中
- 请始终将光盘存放在没有阳光直射的地方
- 请始终将光盘存放在远离直接热源的地方
- 不使用光盘时请将其从计算机中取出
- 每次使用前，请“先”检查光盘是否有裂纹
- 请勿将光盘强行插入计算机 / 包装中
- 请勿弯曲或扭曲光盘

## 保养 CD 或 DVD

数字光盘是高密度介质，必须谨慎操作并保持清洁，以确保它们保持可读。以下预防措施有助于延长光盘寿命。

**警告：** 以圆周运行擦拭光盘可能损坏光盘并导致数据丢失。

- 请握住光盘的边缘或中心孔。请勿触摸光盘表面。
- 要除去灰尘或指纹，请用无绒软布从中心向边缘擦拭光盘。
- 请勿在表面上书写。
- 请勿将光盘置于阳光直射下。
- 请勿使用工业用清洗剂来清洁光盘。
- 请勿弯曲光盘。

## 保养 CD-RW/DVD-ROM 组合驱动器

要在操作过程中保护 CD-RW/DVD-ROM 组合驱动器，请遵循以下预防措施：

- 当驱动器在使用时请勿移动它。这样做可能导致数据错误，或可能损坏驱动器或光盘。
- 避免使驱动器遇到以下情况：
  - 高湿度
  - 高温
  - 过多灰尘
  - 机械振动
  - 意外震动或跌落
  - 置于倾斜表面上
  - 阳光直射
  - 突然的温度变化
- 请勿将不相关的物体插入驱动器中。
- 请勿将物品堆叠在驱动器上。
- 请勿卸下驱动器盖或试图维修驱动器。
- 在移动驱动器部件之前，请从光盘托盘中取出任何光盘，并确保关闭托盘。
- 保存原始包装材料。如果需要将驱动器部件装运到另一位置，请使用原始包装材料以确保驱动器安全运送。

## 手动弹出光盘

如果发生电源故障，且驱动器不能弹出光盘，请关闭计算机，并拉直一个大回形针以形成一个工具。伸直端必须伸出至少 45 mm (1.8 in.)。将伸出端插入驱动器正面的紧急弹出孔中（请参阅第 1-3 页的“驱动器前视图”）。推送回形针直到托盘打开。轻轻地拉出托盘直到您可以取出光盘。

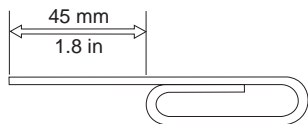



---

## 附录 A. 产品规格

本附录包含以下信息：

- 物理规格
- 电源需求
- 环境需求
- 读速度
- 写速度

### 物理规格

48X/32X/48X/16 Max CD-RW/DVD-ROM 组合驱动器的物理规格<sup>1</sup>在下表中列出。

物理规格	
高度	41.3 mm ( 1.62 in. )
宽度	146 mm ( 5.75 in. )
长度	190 mm ( 7.48 in. )
重量	900 g ( 1.98 lb. )

### 电源需求

下表按电压级别列出了 48X/32X/48X/16 Max CD-RW/DVD-ROM 组合驱动器的电源规格。这些电源规格在驱动器的电源接口处测得，并且都是额定值。

电源规格	电压	平均值	最大
电压	5V dc	700 mA	1300 mA
电压	12V dc	650 mA	1300 mA

---

1. 产品描述数据代表 IBM 的设计目标并出于比较的目的而提供；实际结果可能根据各种因素的不同而有所不同。本产品数据不构成保证。数据如有更改，恕不另行通知。

## 环境需求

规格	运行时	非运行时
温度 (无冷凝)	+5° C 至 +45° C (+41° F 至 +113° F)	-20° C 至 +60° C (-4° F 至 140° F)
相对湿度 (无冷凝)	10% 至 80%	5% 至 90%

## 读速度

介质	持续的数据传输率
DVD-ROM	(6.5x-16x CAV, 4.7 GB DVD-ROM 读) : 8.7 到 22.1 MB/s
DVD-ROM	(3.3x-8x CAV, 8.5 GB 双层读) : 4.4 到 11.0 MB/s
DVD-R	(2.5x-6x CAV, 4.7 GB DVD-R 读) : 3.3 到 8.1 MB/s
DVD+R	(2.5x-6x CAV, 4.7 GB DVD+R 读) : 3.3 到 8.1 MB/s
DVD-R	(2.5x-5x CAV, 3.95 GB DVD-R 读) : 3.3 到 6.7 MB/s
DVD-RAM	(2x CLV, 4.7 GB DVD-RAM 读) : 2.7 MB/s
DVD-RW	(2.5x-6x CAV, 4.7 GB DVD-RW 读) : 3.3 到 8.1 MB/s
DVD+RW	(2.5x-6x CAV, 4.7 GB DVD+RW 读) : 3.3 到 8.1 MB/s
CD-ROM	(20x-48x CAV, CD-ROM 读) : 3.0 到 7.2 MB/s
CD-R	(20x-48x CAV, CD-R 读) : 3.0 到 7.2 MB/s
CD-RW	(18x-40x CAV, CD-RW 读) : 2.7 到 6.0 MB/s

### 最大突发数据传输率 :

- Ultra DMA 方式 2 : 33 MB/s

### 平均存取时间 :

- DVD-ROM (包括等待时间, 单层) : 120 ms
- CD-ROM (包括等待时间) : 110 ms
- RW (包括等待时间) : 110 ms
- 2 MB 数据缓冲区

## 写速度

介质	写速度
CD-R (48X)	3.0 到 7.2 MB/s CAV

介质	写速度
CD-RW <ul style="list-style-type: none"> <li>• 多速 (4X)</li> <li>• 高速 (10X)</li> <li>• 超高速 (最大 24X)</li> <li>• 超高速+ (最大 32X)</li> </ul>	<ul style="list-style-type: none"> <li>• 0.6 MB/s CLV</li> <li>• 1.5 MB/s CLV</li> <li>• 2.4 到 3.6 MB/s PCAV</li> <li>• 3.0 到 4.8 MB/s PCAV</li> </ul>

注：可以水平或垂直安装该驱动器。



---

## 附录 B. 问题解决

计算机问题可能由硬件、软件或用户错误造成。使用本部分中的信息，您也许能自己解决问题或搜集可以传递给服务技术人员的有用信息。您可能还需要参考计算机、操作系统或声卡的文档。

请检查以下列表，以获取可能符合您所遇到情况的任何问题描述。

- 您的计算机或 **CD-RW/DVD-ROM** 组合驱动器运行不正常，或者忙指示灯不亮起。

采取以下操作：

1. 检查光盘是以标签一侧朝上装入的。
2. 检查所有设备已正确连接到计算机和电源插座上。
3. 关闭计算机，拔下计算机和所有连接设备的电缆，并卸下计算机外盖。
4. 检查所有电源线和 IDE 电缆是否妥善连接。断开 IDE 电缆的连接，并检查是否有弯曲或方向偏离的插针。如果未发现任何问题，请重新连接接口电缆。将计算机外盖装回原处，并重新连接所有电缆和电源线。开启计算机，重新启动操作系统，并通过按打开 / 关闭按钮来尝试打开装入托盘。如果托盘未能打开，且忙指示灯不亮起，请关闭计算机并尝试使用另一根 4 芯直流电源线。
5. 检查 IDE 电缆上有颜色代码的一侧与 IDE 接口上的插针 1 对齐，且最靠近 CD-RW/DVD-ROM 组合驱动器上的电源线。请参阅第 1-5 页的『步骤 6. 将电缆连接到驱动器』。
6. 检查 IDE 电缆上的 CD-RW/DVD-ROM 组合驱动器和任何其它设备的设置是否正确。
7. 如果 IDE 电缆的中间接口连接到系统板上的 IDE 接口，请拔下该接口并重新连接电缆。如果 IDE 接口上只有一个设备，请将电缆一端的接口连接到 IDE 接口，而另一端的接口连接到设备上，保留中间接口（如果有一个）空着。

如果 IDE 接口上有两个设备，请将电缆一端的接口连接到 IDE 接口。如果有一个硬盘驱动器，请把它连接到电缆另一端的接口上，而把 CD-RW/DVD-ROM 组合驱动器连接到中间接口上。

- 无法访问 **CD-RW/DVD-ROM** 组合驱动器，或者不显示 **DVD-ROM (CD-ROM)** 图标。

在正确安装了 CD-RW/DVD-ROM 组合驱动器后，DVD-ROM 或 CD-ROM 图标显示在“我的电脑”窗口中。双击我的电脑。如果 CD-ROM 图标不显示在打开的窗口中，请验证是否已正确安装了驱动器。验证是否正确设置了配置跳线。重新启动计算机。如果驱动器图标仍旧不显示，请继续执行以下步骤：

1. 单击开始，单击设置，然后单击控制面板。
2. 单击系统。
3. 单击设备管理器选项卡。
4. 双击依类型排序设备。
5. 从“设备管理器”窗口显示的列表中选择硬盘控制器。验证与控制器不存在冲突。设备状态指示控制器是否在正确工作。

6. 从“设备管理器”窗口显示的列表中选择 **CD-ROM**。验证列表中存在 CD-ROM 设备且不存在冲突。设备状态指示该设备是否在正常工作。
7. 单击确定。
8. 关闭所有窗口并重新启动计算机。

如果仍旧不显示设备图标，请检查电缆连接和设备跳线设置，并解决可能存在的任何冲突。

- 操作系统无法识别 **CD-RW/DVD-ROM** 组合驱动器，或者驱动器运行不稳定。

某些计算机具有用于海量存储设备的“兼容”和“高性能”方式。通常，CD-RW/DVD-ROM 组合驱动器在“高性能”方式下运行的效果较好。但是，如果驱动器在该方式下不能正确运行，则可能需要使用“兼容”方式。

请使用以下过程来检查计算机的配置设置信息。

1. 访问系统配置实用程序。在大多数 IBM 计算机上，当系统启动时按 F1 即可执行该操作。
2. 选择 **Devices**。
3. 向下滚动至 **Mass Storage Devices** 区域。

有关选择 IDE 性能方式的附加详细信息，请参考计算机随附的文档。

- 无法读光盘。

采取以下操作：

1. 光盘可能已弄脏；请如第 1-11 页的『保养 CD 或 DVD』所述来清洁光盘。
  2. 光盘可能损坏；请尝试使用另一张光盘。
  3. 光盘是 ISO-9660、High Sierra Group (HSG) 或 Universal Disc Format (UDF) 不兼容的。请与购买处协商。
- 光盘没有声音。
    1. 确定使用的不是数据 CD。
    2. 调整音频适配器音量控制钮。请参阅音频适配器和音频 CD 播放器程序随附的文档。
    3. 如第 D-1 页的附录 D，『启用数字音频抽取』中所述启用数字音频。
  - 在 **Windows 2000** 下使用 **WinDVD** 时，出现 **Unable to Create Overlay Window** (无法创建重叠窗口) 消息。
    1. 您需要更新视频设备驱动程序以启用重叠支持。请与视频适配器或计算机的制造商联系以获取更新。某些设备驱动程序已在 *IBM CD-RW/DVD-ROM 软件和用户指南 CD* 上提供。
    2. 屏幕分辨率可能过高。尝试将分辨率设置为 800 x 600 x 16 bpp, 60 Hz。
  - 当将 **DVD** 插入 **CD-RW/DVD-ROM** 组合驱动器后，**DVD** 电影不自动开始播放。
    1. 自动播放已关闭。请按照以下说明操作以打开自动播放：
      - a. 单击开始，然后单击控制面板，然后单击设备管理器。
      - b. 选中自动插入通告。
    2. 既包含程序，又包含 DVD 视频内容的 DVD 将自动播放程序内容。要观看视频内容，请手工启动 WinDVD。有关手工启动 WinDVD 的更多信息，请参阅第 1-10 页的『观看 DVD 电影』。

- 视频看起来不连贯或掉帧。
  1. 确保对您的计算机硬盘驱动器控制器启用了 DMA。
  2. 屏幕分辨率可能过高。尝试将分辨率设置为 800 x 600 x 16 bpp, 60 Hz。
  3. 如果您的计算机微处理器的性能低于奔腾 II 450 微处理器, 则在某些 DVD 上出现一点抖动是正常的。
- 不重新启动系统的情况下不能在 **Windows 2000** 系统中读 **CD** 介质 (数据或音频)。
  1. “IBM Rapid Access II 键盘”设备驱动程序可能会妨碍 CD 驱动器运行。
    - a. 通过“控制面板”中的“添加/删除程序”来除去“Rapid Access II 键盘”设备驱动程序。
    - b. 如果您有“Rapid Access II 键盘”并想复原其功能, 则需要访问 IBM 支持 Web 站点以下载最新的设备驱动程序 (版本 1007 或更高版本)。





---

## 附录 C. 定制设备驱动程序配置设置

Windows Me 有两个设备驱动程序配置参数：“自动插入通告”和 DMA。

“自动插入通告”参数使计算机能在光盘插入驱动器后自动开始播放或访问光盘。

DMA 参数通过将计算机 DMA 控制器句柄数据从 CD 转移到内存，释放计算机微处理器来执行更重要的任务，从而改善了计算机性能。例如，激活 DMA 可能使电影和游戏运行更流畅，因为微处理器将分配给视频更长的处理时间。

---

### 对 Windows Me 启用 DMA

要从 Windows Me 桌面更改 DMA 参数设置，请执行以下操作：

1. 单击开始 --> 设置 --> 控制面板。
2. 单击查看所有控制面板选项。
3. 双击系统。
4. 单击设备管理器选项卡。
5. 双击 **CD-ROM**。
6. 单击要修改的驱动器。
7. 单击设置选项卡。
8. 单击以选中 **DMA** 复选框。
9. 单击确定。

---

### 启用 Windows 2000 的 DMA

要更改 Windows 2000 的 DMA 参数设置，请执行以下操作：

1. 单击开始 --> 设置 --> 控制面板。
2. 双击系统。
3. 单击硬件选项卡。
4. 单击设备管理器。
5. 单击 **IDE ATA/ATAPI 控制器**以展开树。
6. 双击与 CD-ROM 端口的相对应的设备。设备是 **Primary IDE Channel** 或 **Secondary IDE Channel**。
7. 单击高级设置选项卡。
8. 单击传送方式菜单并选择 **DMA**（若可用）。
9. 单击确定。
10. 单击关闭以关闭“系统属性”窗口。显示一条消息，通知您系统设置已更改。
11. 单击确定以重新启动计算机。

---

## 对 Windows XP 启用 DMA

要从 Windows XP 桌面更改 DMA 参数设置，请执行以下操作：

1. 单击开始 --> 控制面板。
2. 单击切换到经典视图。
3. 双击系统。
4. 单击硬件选项卡。
5. 单击设备管理器按钮。
6. 单击 **IDE ATA/ATAPI** 控制器以展开树。
7. 双击与 CD-RW 所在位置相对应的控制器（主要 **IDE** 通道或次要 **IDE** 通道）。
8. 单击高级设置选项卡。
9. 选择与 CD-RW 位置相对应的适当传送方式下拉列表，（设备 **0** 为主设备、设备 **1** 为从设备）。
10. 选择 **DMA**（若可用）。
11. 单击确定。

## 附录 D. 启用数字音频抽取

系统必须正确配置以便从该驱动器回放数字音频。有两个设置必须配置。一个设置在设备属性中，而第二个设置在 Windows Media Player 中。

要设置设备属性，请采用以下过程：

1. 右键单击我的电脑，选择“属性”。

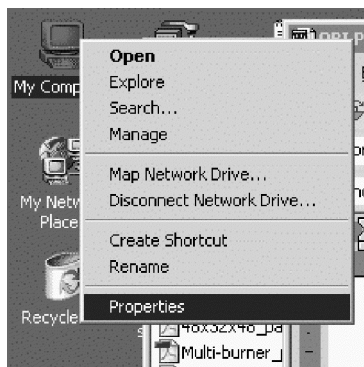

2. 从“硬件”选项卡选择“设备管理器”。在 Windows Me 中，“硬件”选项卡直接显示“设备管理器”而不需要单击按钮。

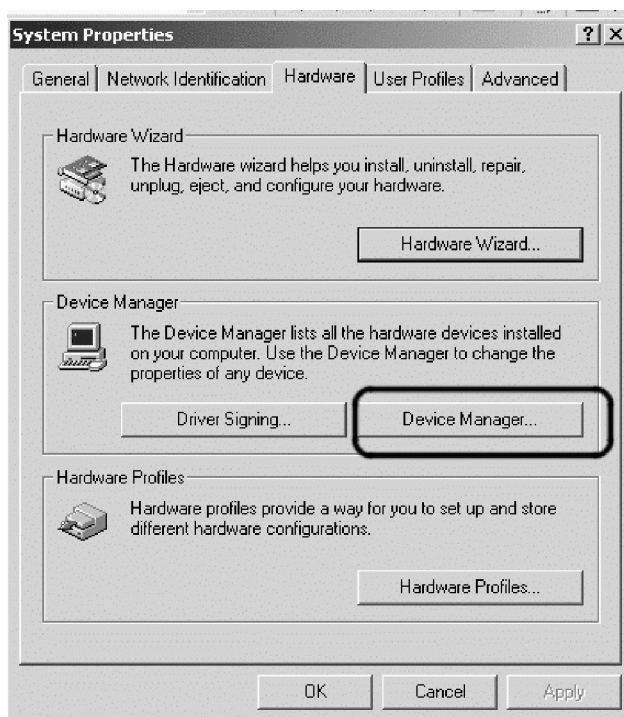

3. 在“设备管理器”中，单击 DVD/CD-ROM 驱动器的 +，右键单击驱动器，然后选择“属性”。



4. 选择“属性”选项卡，选中“启用数字音频”复选框。

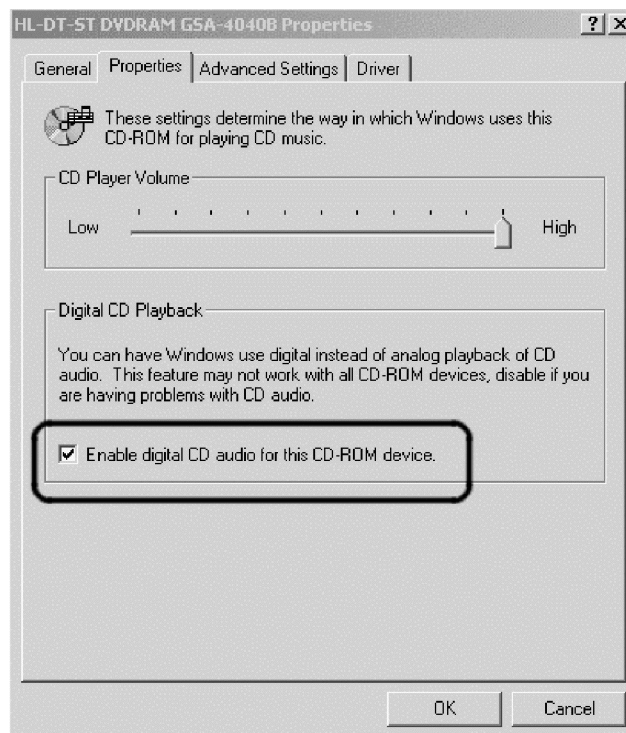

要在 Windows Media Player 中启用“数字音频回放”，请执行以下步骤：

- a. 打开 Windows Media Player。
- b. 从 Media Player 菜单选择工具 → 选项...
- c. 选择“CD 音频”选项卡并且选中“数字播放”框

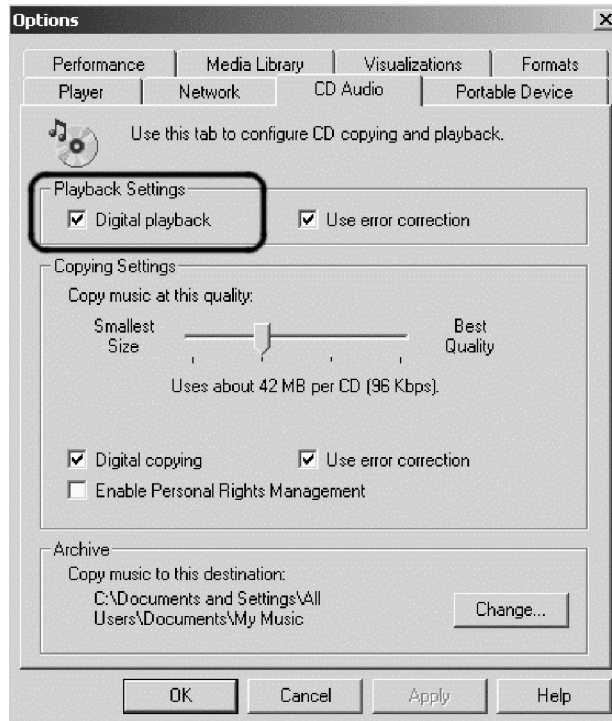



---

## 附录 E. 服务与支持

以下信息描述了在保修期内或产品使用过程中对您产品可用的技术支持。有关 IBM 保修条款的完整解释，请参考 IBM 有限保证声明。

---

### 联机技术支持

在产品使用过程中，联机技术支持可通过以下个人计算支持 Web 站点获取：

[www.ibm.com/pc/support](http://www.ibm.com/pc/support)

在保修期内，可帮助更换或调换质量有问题的组件。另外，如果 IBM 选件安装在 IBM 计算机中，则可能有权在当地进行维修。技术支持代表可以帮助您确定最好的备用方法。

---

### 电话技术支持

根据 IBM 的决定，在选件从市场上撤销后 90 天内，通过 IBM HelpCenter® 的安装和配置支持将被撤销或者进行有偿使用。在支付一定费用后，您可以获得其它的支持（包括循序渐进的安装帮助）。

要协助技术支持代表，请尽可能地获取以下信息：

- 选件名称
- 选件号
- 购货凭证
- 计算机制造商、型号、序列号（如果是 IBM 的产品）和手册
- 错误消息（如果有的话）的确切描述
- 问题描述
- 系统的硬件和软件配置信息

如果可能，请呆在计算机旁边。技术支持代表可能希望通过电话来逐步指导您解决问题。

对于您所在国家或地区的支持电话号码和支持时段，请参考下表。如果您所在国家或地区的电话号码没有列出，请致电 IBM 经销商或 IBM 销售代表。回复时间可能根据您拨打的电话号码的不同以及您在电话中所描述问题的性质的不同而有所不同。

电话号码如有更改，恕不另行通知。有关电话号码的最新列表，请转至 [www.ibm.com/pc/support](http://www.ibm.com/pc/support) 并且单击 **Support Phone List**。

国家或地区	电话号码	国家或地区	电话号码
阿根廷	0800-666-0011	马来西亚	03-7727-7800
澳大利亚	1300-130-426	墨西哥	001-866-434-2080
奥地利	01-24592-5901	荷兰	020-514-5770

国家或地区	电话号码	国家或地区	电话号码
比利时	荷兰语 02-210-9820 法语 02-210-9800	新西兰	0800-446-149
玻利维亚	0800-0189	挪威	66 81 11 00
巴西	55-11-3889-8986	秘鲁	0-800-50-866
加拿大	1-800-565-3344 多伦多 416-383-3344	菲律宾	632-995-2225
智利	800-224-488	葡萄牙	21-791 51 47
中国 ( PRC )	800-810-1818	俄罗斯	095-940-2000
中国香港特别行政区	852-2825-7799	新加坡	1800-840-9911
哥伦比亚	980-912-3021	西班牙	91-662 49 16
丹麦	45 20 82 00	瑞典	08-477 4420
厄瓜多尔	1-800-426911 ( 选项 #4 )	瑞士	058-333-09-00
芬兰	09-459 69 60	台湾	886-2-2725-9799
法国	02 38 55 74 50	泰国	66-2-273-4000
德国	07032-1549 201	土耳其	00-800-446-32-041
印度尼西亚	021-523-8535	英国	0-1475-555 055
爱尔兰	01-815-9202	美国	1-800-426-7378
意大利	02-7031-6101	乌拉圭	000-411-005-6649
日本	消费者 0120-887-870 商业客户 0120-887-874	委内瑞拉	0-800-100-2011
卢森堡	298-977 5063	越南	848-8295-160



---

## 附录 F. IBM Statement of Limited Warranty - Z125-4753-07 - 11/2002

### Part 1 - General Terms

*This Statement of Limited Warranty includes Part 1 - General Terms, Part 2 - Country-unique Terms, and Part 3 - Warranty Information. The terms of Part 2 replace or modify those of Part 1. The warranties provided by IBM in this Statement of Limited Warranty apply only to Machines you purchase for your use, and not for resale. The term "Machine" means an IBM machine, its features, conversions, upgrades, elements, or accessories, or any combination of them. The term "Machine" does not include any software programs, whether pre-loaded with the Machine, installed subsequently or otherwise. **Nothing in this Statement of Limited Warranty affects any statutory rights of consumers that cannot be waived or limited by contract.***

### What this Warranty Covers

IBM warrants that each Machine 1) is free from defects in materials and workmanship and 2) conforms to IBM's Official Published Specifications ("Specifications") which are available on request. The warranty period for the Machine starts on the original Date of Installation and is specified in Part 3 - Warranty Information. The date on your invoice or sales receipt is the Date of Installation unless IBM or your reseller informs you otherwise. Many features, conversions, or upgrades involve the removal of parts and their return to IBM. A part that replaces a removed part will assume the warranty service status of the removed part. Unless IBM specifies otherwise, these warranties apply only in the country or region in which you purchased the Machine.

**THESE WARRANTIES ARE YOUR EXCLUSIVE WARRANTIES AND REPLACE ALL OTHER WARRANTIES OR CONDITIONS, EXPRESS OR IMPLIED, INCLUDING, BUT NOT LIMITED TO, THE IMPLIED WARRANTIES OR CONDITIONS OF MERCHANTABILITY AND FITNESS FOR A PARTICULAR PURPOSE. SOME STATES OR JURISDICTIONS DO NOT ALLOW THE EXCLUSION OF EXPRESS OR IMPLIED WARRANTIES, SO THE ABOVE EXCLUSION MAY NOT APPLY TO YOU. IN THAT EVENT, SUCH WARRANTIES ARE LIMITED IN DURATION TO THE WARRANTY PERIOD. NO WARRANTIES APPLY AFTER THAT PERIOD. SOME STATES OR JURISDICTIONS DO NOT ALLOW LIMITATIONS ON HOW LONG AN IMPLIED WARRANTY LASTS, SO THE ABOVE LIMITATION MAY NOT APPLY TO YOU.**

### What this Warranty Does not Cover

This warranty does not cover the following:

- any software programs, whether pre-loaded or shipped with the Machine, or installed subsequently;

- failure resulting from misuse (including but not limited to use of any Machine capacity or capability, other than that authorized by IBM in writing), accident, modification, unsuitable physical or operating environment, or improper maintenance by you;
- failure caused by a product for which IBM is not responsible; and
- any non-IBM products, including those that IBM may procure and provide with or integrate into an IBM Machine at your request.

The warranty is voided by removal or alteration of identification labels on the Machine or its parts.

IBM does not warrant uninterrupted or error-free operation of a Machine.

Any technical or other support provided for a Machine under warranty, such as assistance via telephone with "how-to" questions and those regarding Machine set-up and installation, is provided **WITHOUT WARRANTIES OF ANY KIND**.

### **How to Obtain Warranty Service**

If the Machine does not function as warranted during the warranty period, contact IBM or your reseller to obtain warranty service. If you do not register the Machine with IBM, you may be required to present proof of purchase as evidence of your entitlement to warranty service.

### **What IBM Will Do to Correct Problems**

When you call for service, you must follow the problem determination and resolution procedures that IBM specifies. A technician will attempt to make an initial diagnosis of your problem and help you resolve it over the telephone.

The type of warranty service applicable to your Machine is specified in Part 3 - Warranty Information.

You are responsible for downloading and installing designated Machine Code (microcode, basic input/output system code (called "BIOS"), utility programs, device drivers, and diagnostics delivered with an IBM Machine ) and other software updates from an IBM Internet Web site or from other electronic media, and following the instructions that IBM provides.

If your problem can be resolved with a Customer Replaceable Unit ("CRU") (e.g., keyboard, mouse, speaker, memory, hard disk drive and other easily replaceable parts), IBM will ship these parts to you for replacement by you.

If the Machine does not function as warranted during the warranty period and your problem cannot be resolved over the telephone, through your application of Machine Code or software updates, or with a CRU, IBM or your reseller, if approved by IBM to provide warranty service, will either, at its discretion, 1) repair it to make it function as warranted, or 2) replace it with one that is at least functionally equivalent. If IBM is unable to do either, you may return the Machine to your place of purchase and your money will be refunded.

IBM or your reseller will also manage and install selected engineering changes that apply to the Machine.

### **Exchange of a Machine or Part**

When the warranty service involves the exchange of a Machine or part, the item IBM or your reseller replaces becomes its property and the replacement becomes yours. You represent that all removed items are genuine and unaltered. The replacement may not be new, but will be in good working order and at least functionally equivalent to the item replaced. The replacement assumes the warranty service status of the replaced item.

### **Your Additional Responsibilities**

Before IBM or your reseller exchanges a Machine or part, you agree to remove all features, parts, options, alterations, and attachments not under warranty service.

You also agree to:

1. ensure that the Machine is free of any legal obligations or restrictions that prevent its exchange;
2. obtain authorization from the owner to have IBM or your reseller service a Machine that you do not own; and
3. where applicable, before service is provided:
  - a. follow the service request procedures that IBM or your reseller provides;
  - b. backup or secure all programs, data, and funds contained in the Machine;
  - c. IBM or your reseller with sufficient, free, and safe access to your facilities to permit IBM to fulfill its obligations; and
  - d. inform IBM or your reseller of changes in the Machine's location.
4. (a) ensure all information about identified or identifiable individuals (Personal Data) is deleted from the Machine (to the extent technically possible), (b) allow IBM, your reseller or an IBM supplier to process on your behalf any remaining Personal Data as IBM or your reseller considers necessary to fulfill its obligations under this Statement of Limited Warranty (which may include shipping the Machine for such processing to other IBM service locations around the world), and (c) ensure that such processing complies with any laws applicable to such Personal Data.

### **Limitation of Liability**

IBM is responsible for loss of, or damage to, your Machine only while it is 1) in IBM's possession or 2) in transit in those cases where IBM is responsible for the transportation charges.

Neither IBM nor your reseller are responsible for any of your confidential, proprietary or personal information contained in a Machine which you return to IBM for any reason. You should remove all such information from the Machine prior to its return.

Circumstances may arise where, because of a default on IBM's part or other liability, you are entitled to recover damages from IBM. In each such instance, regardless of the basis on which you are entitled to claim damages from IBM (including fundamental breach, negligence, misrepresentation, or other contract or tort claim), except for any liability that cannot be waived or limited by applicable laws, IBM is liable for no more than

1. damages for bodily injury (including death) and damage to real property and tangible personal property; and
2. the amount of any other actual direct damages, up to the charges (if recurring, 12 months' charges apply) for the Machine that is subject of the claim. For purposes of this item, the term "Machine" includes Machine Code and Licensed Internal Code ("LIC").

This limit also applies to IBM's suppliers and your reseller. It is the maximum for which IBM, its suppliers, and your reseller are collectively responsible.

**UNDER NO CIRCUMSTANCES IS IBM, ITS SUPPLIERS OR RESELLERS LIABLE FOR ANY OF THE FOLLOWING EVEN IF INFORMED OF THEIR POSSIBILITY: 1) THIRD PARTY CLAIMS AGAINST YOU FOR DAMAGES (OTHER THAN THOSE UNDER THE FIRST ITEM LISTED ABOVE); 2) LOSS OF, OR DAMAGE TO, DATA; 3) SPECIAL, INCIDENTAL, OR INDIRECT DAMAGES OR FOR ANY ECONOMIC CONSEQUENTIAL DAMAGES; OR 4) LOST PROFITS, BUSINESS REVENUE, GOODWILL OR ANTICIPATED SAVINGS. SOME STATES OR JURISDICTIONS DO NOT ALLOW THE EXCLUSION OR LIMITATION OF INCIDENTAL OR CONSEQUENTIAL DAMAGES, SO THE ABOVE LIMITATION OR EXCLUSION MAY NOT APPLY TO YOU. SOME STATES OR JURISDICTIONS DO NOT ALLOW LIMITATIONS ON HOW LONG AN IMPLIED WARRANTY LASTS, SO THE ABOVE LIMITATION MAY NOT APPLY TO YOU.**

#### **Governing Law**

Both you and IBM consent to the application of the laws of the country in which you acquired the Machine to govern, interpret, and enforce all of your and IBM's rights, duties, and obligations arising from, or relating in any manner to, the subject matter of this Statement of Limited Warranty, without regard to conflict of law principles.

**THESE WARRANTIES GIVE YOU SPECIFIC LEGAL RIGHTS AND YOU MAY ALSO HAVE OTHER RIGHTS WHICH VARY FROM STATE TO STATE OR JURISDICTION TO JURISDICTION.**

#### **Jurisdiction**

All of our rights, duties, and obligations are subject to the courts of the country in which you acquired the Machine.

---

## **Part 2 - Country-unique Terms**

### **AMERICAS**

#### **ARGENTINA**

**Governing Law:** *The following is added after the first sentence:*

Any litigation arising from this Statement of Limited Warranty will be settled exclusively by the Ordinary Commercial Court of the city of Buenos Aires.

#### **BRAZIL**

**Governing Law:** *The following is added after the first sentence:*

Any litigation arising from this Statement of Limited Warranty will be settled exclusively by the court of Rio de Janeiro, RJ.

## **Peru**

**Limitation of Liability:** *The following is added at the end of this section:*

In accordance with Article 1328 of the Peruvian Civil Code the limitations and exclusions specified in this section will not apply to damages caused by IBM's willful misconduct ("dolo") or gross negligence ("culpa inexcusable").

## **NORTH AMERICA**

**How to Obtain Warranty Service:** *The following is added to this Section:*

To obtain warranty service from IBM in Canada or the United States, call 1-800-IBM-SERV (426-7378).

## **CANADA**

**Limitation of Liability:** *The following replaces item 1 of this section:*

1. damages for bodily injury (including death) or physical harm to real property and tangible personal property caused by IBM's negligence; and

**Governing Law:** *The following replaces ¶laws of the country in which you acquired the Machine in the first sentence:*  
laws in the Province of Ontario.

## **UNITED STATES**

**Governing Law:** *The following replaces ¶laws of the country in which you acquired the Machine in the first sentence:*  
laws of the State of New York.

## **ASIA PACIFIC**

### **AUSTRALIA**

**What this Warranty Covers:** *The following paragraph is added to this Section:*

The warranties specified in this Section are in addition to any rights you may have under the Trade Practices Act 1974 or other similar legislation and are only limited to the extent permitted by the applicable legislation.

**Limitation of Liability:** *The following is added to this Section:*

Where IBM is in breach of a condition or warranty implied by the Trade Practices Act 1974 or other similar legislation, IBM's liability is limited to the repair or replacement of the goods or the supply of equivalent goods. Where that condition or warranty relates to right to sell, quiet possession or clear title, or the goods are of a kind ordinarily acquired for personal, domestic or household use or consumption, then none of the limitations in this paragraph apply.

**Governing Law:** *The following replaces ¶laws of the country in which you acquired the Machine in the first sentence:*  
laws of the State or Territory.

### **CAMBODIA, LAOS, AND VIETNAM**

**Governing Law:** *The following replaces ¶laws of the country in which you acquired the Machine in the first sentence:*  
laws of the State of New York, United States of America.

### **CAMBODIA, INDONESIA, LAOS, AND VIETNAM**

*Arbitration: The following is added under this heading:*

Disputes arising out of or in connection with this Statement of Limited Warranty shall be finally settled by arbitration which shall be held in Singapore in accordance with the Arbitration Rules of Singapore International Arbitration Center ("SIAC Rules") then in effect. The arbitration award shall be final and binding for the parties without appeal and shall be in writing and set forth the findings of fact and the conclusions of law.

The number of arbitrators shall be three, with each side to the dispute being entitled to appoint one arbitrator. The two arbitrators appointed by the parties shall appoint a third arbitrator who shall act as chairman of the proceedings. Vacancies in the post of chairman shall be filled by the president of the SIAC. Other vacancies shall be filled by the respective nominating party. Proceedings shall continue from the stage they were at when the vacancy occurred.

If one of the parties refuses or otherwise fails to appoint an arbitrator within 30 days of the date the other party appoints its, the first appointed arbitrator shall be the sole arbitrator, provided that the arbitrator was validly and properly appointed.

All proceedings shall be conducted, including all documents presented in such proceedings, in the English language. The English language version of this Statement of Limited Warranty prevails over any other language version.

### **HONG KONG S.A.R. OF CHINA AND MACAU S.A.R. OF CHINA**

**Governing Law:** *The following replaces ¶laws of the country in which you acquired the Machine in the first sentence:*  
laws of Hong Kong Special Administrative Region of China.

### **INDIA**

**Limitation of Liability:** *The following replaces items 1 and 2 of this Section:*

1. liability for bodily injury (including death) or damage to real property and tangible personal property will be limited to that caused by IBM's negligence; and
2. as to any other actual damage arising in any situation involving nonperformance by IBM pursuant to, or in any way related to the subject of this Statement of Limited Warranty, , the charge paid by you for the individual Machine that is the subject of the claim. For purposes of this item, the term "Machine" includes Machine Code and Licensed Internal Code ("LIC").

**Arbitration:** *The following is added under this heading :*

Disputes arising out of or in connection with this Statement of Limited Warranty shall be finally settled by arbitration which shall be held in Bangalore, India in accordance with the laws of India then in effect. The arbitration award shall be final and binding for the parties without appeal and shall be in writing and set forth the findings of fact and the conclusions of law.

The number of arbitrators shall be three, with each side to the dispute being entitled to appoint one arbitrator. The two arbitrators appointed by the parties shall appoint a third arbitrator who shall act as chairman of the proceedings. Vacancies in the post of chairman shall be filled by the president of the Bar Council of India. Other vacancies shall be filled by the respective nominating party. Proceedings shall continue from the stage they were at when the vacancy occurred.

If one of the parties refuses or otherwise fails to appoint an arbitrator within 30 days of the date the other party appoints its, the first appointed arbitrator shall be the sole arbitrator, provided that the arbitrator was validly and properly appointed.

All proceedings shall be conducted, including all documents presented in such proceedings, in the English language. The English language version of this Statement of Limited Warranty prevails over any other language version.

## **JAPAN**

**Governing Law:** *The following sentence is added to this section:*

Any doubts concerning this Statement of Limited Warranty will be initially resolved between us in good faith and in accordance with the principle of mutual trust.

## **MALAYSIA**

**Limitation of Liability:** *The word "SPECIAL" in item 3 of the fifth paragraph is deleted.*

## **NEW ZEALAND**

**What this Warranty Covers:** *The following paragraph is added to this section:*

The warranties specified in this section are in addition to any rights you may have under the Consumer Guarantees Act 1993 or other legislation which cannot be excluded or limited. The Consumer Guarantees Act 1993 will not apply in respect of any goods which IBM provides, if you require the goods for the purposes of a business as defined in that Act.

**Limitation of Liability:** *The following is added to this section:*

Where Machines are not acquired for the purposes of a business as defined in the Consumer Guarantees Act 1993, the limitations in this section are subject to the limitations in that Act.

## **PEOPLE'S REPUBLIC OF CHINA (PRC)**

**Governing Law:** *The following replaces "laws of the country in which you acquired the Machine" in the first sentence:*

laws of the State of New York, United States of America (except when local law requires otherwise).

## **PHILIPPINES**

**Limitation of Liability:** *Item 3 in the fifth paragraph is replaced by the following:*

**SPECIAL (INCLUDING NOMINAL AND EXEMPLARY DAMAGES), MORAL, INCIDENTAL, OR INDIRECT DAMAGES FOR ANY ECONOMIC CONSEQUENTIAL DAMAGES; OR**

**Arbitration:** The following is added under this heading

Disputes arising out of or in connection with this Statement of Limited Warranty shall be finally settled by arbitration which shall be held in Metro Manila, Philippines in accordance with the laws of the Philippines then in effect. The arbitration award shall be final and binding for the parties without appeal and shall be in writing and set forth the findings of fact and the conclusions of law.

The number of arbitrators shall be three, with each side to the dispute being entitled to appoint one arbitrator. The two arbitrators appointed by the parties shall appoint a third arbitrator who shall act as chairman of the proceedings. Vacancies in the post of chairman shall be filled by the president of the Philippine Dispute Resolution Center, Inc.. Other vacancies shall be filled by the respective nominating party. Proceedings shall continue from the stage they were at when the vacancy occurred.

If one of the parties refuses or otherwise fails to appoint an arbitrator within 30 days of the date the other party appoints its, the first appointed arbitrator shall be the sole arbitrator, provided that the arbitrator was validly and properly appointed.

All proceedings shall be conducted, including all documents presented in such proceedings, in the English language. The English language version of this Statement of Limited Warranty prevails over any other language version.

## **SINGAPORE**

**Limitation of Liability:** The words "**SPECIAL**" and "**ECONOMIC**" in item 3 in the fifth paragraph are deleted.

## **EUROPE, MIDDLE EAST, AFRICA (EMEA)**

### ***THE FOLLOWING TERMS APPLY TO ALL EMEA COUNTRIES:***

The terms of this Statement of Limited Warranty apply to Machines purchased from IBM or an IBM reseller.

**How to Obtain Warranty Service:** If you purchase a Machine in Austria, Belgium, Cyprus, Denmark, Estonia, Finland, France, Germany, Greece, Iceland, Ireland, Italy, Latvia, Liechtenstein, Lithuania, Luxembourg, Monaco, Netherlands, Norway, Portugal, Spain, San Marino, Sweden, Switzerland, United Kingdom or Vatican State, you may obtain warranty service for that Machine in any of those countries from either (1) an IBM reseller approved to perform warranty service or (2) from IBM, provided the Machine has been announced and made available by IBM in the country in which you wish to obtain service. If you



purchased a Personal Computer Machine in Albania, Armenia, Belarus, Bosnia and Herzegovina, Bulgaria, Croatia, Czech Republic, Georgia, Hungary, Kazakhstan, Kyrgyzstan, Federal Republic of Yugoslavia, Former Yugoslav Republic of Macedonia (FYROM), Moldova, Poland, Romania, Russia, Slovak Republic, Slovenia, or Ukraine, you may obtain warranty service for that Machine in any of those countries from either (1) an IBM reseller approved to perform warranty service or (2) from IBM.

If you purchase a Machine in a Middle Eastern or African country, you may obtain warranty service for that Machine from the IBM entity within the country of purchase, if that IBM entity provides warranty service in that country, or from an IBM reseller, approved by IBM to perform warranty service on that Machine in that country. Warranty service in Africa is available within 50 kilometers of an IBM approved service provider. You are responsible for transportation costs for Machines located outside 50 kilometers of an IBM approved service provider.

*Add the following paragraph in **Western Europe** (Austria, Belgium, Cyprus, Denmark, Finland, France, Germany, Greece, Iceland, Ireland, Italy, Liechtenstein, Luxembourg, Monaco, Netherlands, Norway, Portugal, Spain, San Marino, Sweden, Switzerland, United Kingdom, Vatican State):*

The warranty for Machines acquired in Western Europe shall be valid and applicable in all Western Europe countries provided the Machines have been announced and made available in such countries.

#### **Governing Law:**

*The phrase "the laws of the country in which you acquired the Machine" is replaced by:*

1) "the laws of Austria" in **Albania, Armenia, Azerbaijan, Belarus, Bosnia-Herzegovina, Bulgaria, Croatia, Georgia, Hungary, Kazakhstan, Kyrgyzstan, FYR Macedonia, Moldova, Poland, Romania, Russia, Slovakia, Slovenia, Tajikistan, Turkmenistan, Ukraine, Uzbekistan, and FR Yugoslavia;** 2) "the laws of France" in **Algeria, Benin, Burkina Faso, Cameroon, Cape Verde, Central African Republic, Chad, Comoros, Congo Republic, Djibouti, Democratic Republic of Congo, Equatorial Guinea, French Guiana, French Polynesia, Gabon, Gambia, Guinea, Guinea-Bissau, Ivory Coast, Lebanon, Madagascar, Mali, Mauritania, Mauritius, Mayotte, Morocco, New Caledonia, Niger, Reunion, Senegal, Seychelles, Togo, Tunisia, Vanuatu, and Wallis & Futuna;** 3) "the laws of Finland" in **Estonia, Latvia, and Lithuania;** 4) "the laws of England" in **Angola, Bahrain, Botswana, Burundi, Egypt, Eritrea, Ethiopia, Ghana, Jordan, Kenya, Kuwait, Liberia, Malawi, Malta, Mozambique, Nigeria, Oman, Pakistan, Qatar, Rwanda, Sao Tome, Saudi Arabia, Sierra Leone, Somalia, Tanzania, Uganda, United Arab Emirates, the United Kingdom, West Bank/Gaza, Yemen, Zambia, and Zimbabwe;** and 5) "the laws of South Africa" in **South Africa, Namibia, Lesotho and Swaziland.**

**Jurisdiction:** *The following exceptions are added to this section:*

1) In **Austria** the choice of jurisdiction for all disputes arising out of this Statement of Limited Warranty and relating thereto, including its existence, will be the competent court of law in Vienna, Austria (Inner-City); 2) in **Angola, Bahrain, Botswana, Burundi, Egypt, Eritrea, Ethiopia, Ghana, Jordan, Kenya, Kuwait, Liberia, Malawi, Malta, Mozambique, Nigeria, Oman, Pakistan, Qatar, Rwanda, Sao Tome, Saudi Arabia, Sierra Leone, Somalia, Tanzania, Uganda, United Arab Emirates, West Bank/Gaza, Yemen, Zambia, and Zimbabwe** all disputes arising out of this Statement of Limited Warranty or related to its execution, including summary proceedings, will be submitted to the exclusive jurisdiction of the English courts; 3) in **Belgium and Luxembourg**, all disputes arising out of this Statement of Limited Warranty or related to its interpretation or its execution, the law, and the courts of the capital city, of the country of your registered office and/or commercial site location only are competent; 4) in **France, Algeria, Benin, Burkina Faso, Cameroon, Cape Verde, Central African Republic, Chad, Comoros, Congo Republic, Djibouti, Democratic Republic of Congo, Equatorial Guinea, French Guiana, French Polynesia, Gabon, Gambia, Guinea, Guinea-Bissau, Ivory Coast, Lebanon, Madagascar, Mali, Mauritania, Mauritius, Mayotte, Morocco, New Caledonia, Niger, Reunion, Senegal, Seychelles, Togo, Tunisia, Vanuatu, and Wallis & Futuna** all disputes arising out of this Statement of Limited Warranty or related to its violation or execution, including summary proceedings, will be settled exclusively by the Commercial Court of Paris; 5) in **Russia**, all disputes arising out of or in relation to the interpretation, the violation, the termination, the nullity of the execution of this Statement of Limited Warranty shall be settled by Arbitration Court of Moscow; 6) in **South Africa, Namibia, Lesotho and Swaziland**, both of us agree to submit all disputes relating to this Statement of Limited Warranty to the jurisdiction of the High Court in Johannesburg; 7) in **Turkey** all disputes arising out of or in connection with this Statement of Limited Warranty shall be resolved by the Istanbul Central (Sultanahmet) Courts and Execution Directorates of Istanbul, the Republic of Turkey; 8) in each of the following specified countries, any legal claim arising out of this Statement of Limited Warranty will be brought before, and settled exclusively by, the competent court of a) Athens for **Greece**, b) Tel Aviv-Jaffa for **Israel**, c) Milan for **Italy**, d) Lisbon for **Portugal**, and e) Madrid for **Spain**; and 9) in **the United Kingdom**, both of us agree to submit all disputes relating to this Statement of Limited Warranty to the jurisdiction of the English courts.

**Arbitration:** *The following is added under this heading:*

In **Albania, Armenia, Azerbaijan, Belarus, Bosnia-Herzegovina, Bulgaria, Croatia, Georgia, Hungary, Kazakhstan, Kyrgyzstan, FYR Macedonia, Moldova, Poland, Romania, Russia, Slovakia, Slovenia, Tajikistan, Turkmenistan, Ukraine, Uzbekistan, and FR Yugoslavia** all disputes arising out of this Statement of Limited Warranty or related to its violation, termination or nullity will be finally settled under the Rules of Arbitration and Conciliation of the International Arbitral Center of the Federal Economic Chamber in Vienna (Vienna Rules) by three arbitrators appointed in accordance with these rules. The arbitration will be held in Vienna, Austria, and the official language of the proceedings will be English. The decision of the arbitrators will be final and binding upon both parties. Therefore, pursuant to paragraph 598 (2) of the Austrian Code of Civil Procedure, the parties expressly waive the application of paragraph 595 (1) figure 7 of the Code. IBM may, however, institute proceedings in a competent court in the country of installation.

**In Estonia, Latvia and Lithuania** all disputes arising in connection with this Statement of Limited Warranty will be finally settled in arbitration that will be held in Helsinki, Finland in accordance with the arbitration laws of Finland then in effect. Each party will appoint one arbitrator. The arbitrators will then jointly appoint the chairman. If arbitrators cannot agree on the chairman, then the Central Chamber of Commerce in Helsinki will appoint the chairman.

## **EUROPEAN UNION (EU)**

### ***THE FOLLOWING TERMS APPLY TO ALL EU COUNTRIES:***

Consumers have legal rights under applicable national legislation governing the sale of consumer goods. Such rights are not affected by the warranties provided in this Statement of Limited Warranty.

#### **How to Obtain Warranty Service:** *The following is added to this section:*

To obtain warranty service from IBM in EU countries, see the telephone listing in Part 3 - Warranty Information.

You may contact IBM at the following address:

IBM Warranty & Service Quality Dept.

PO Box 30

Spango Valley

Greenock

Scotland PA 16 OAH

## **AUSTRIA, DENMARK, FINLAND, GREECE, ITALY, NETHERLANDS, PORTUGAL, SPAIN, SWEDEN AND SWITZERLAND**

#### **Limitation of Liability:** *The following replaces the terms of this section in its entirety:*

Except as otherwise provided by mandatory law:

1. IBM's liability for any damages and losses that may arise as a consequence of the fulfillment of its obligations under or in connection with this Statement of Limited Warranty or due to any other cause related to this Statement of Limited Warranty is limited to the compensation of only those damages and losses proved and actually arising as an immediate and direct consequence of the non-fulfillment of such obligations (if IBM is at fault) or of such cause, for a maximum amount equal to the charges you paid for the Machine. For purposes of this item, the term "Machine" includes Machine Code and Licensed Internal Code ("LIC").

The above limitation shall not apply to damages for bodily injuries (including death) and damages to real property and tangible personal property for which IBM is legally liable.

2. **UNDER NO CIRCUMSTANCES IS IBM, ITS SUPPLIERS OR RESELLERS LIABLE FOR ANY OF THE FOLLOWING, EVEN IF INFORMED OF THEIR**

**POSSIBILITY: 1) LOSS OF, OR DAMAGE TO, DATA; 2) INCIDENTAL OR INDIRECT DAMAGES, OR FOR ANY ECONOMIC CONSEQUENTIAL DAMAGES; 3) LOST PROFITS, EVEN IF THEY ARISE AS AN IMMEDIATE CONSEQUENCE OF THE EVENT THAT GENERATED THE DAMAGES; OR 4) LOSS OF BUSINESS, REVENUE, GOODWILL, OR ANTICIPATED SAVINGS.**

## **FRANCE AND BELGIUM**

**Limitation of Liability:** *The following replaces the terms of this section in its entirety:*

Except as otherwise provided by mandatory law:

1. IBM's liability for any damages and losses that may arise as a consequence of the fulfillment of its obligations under or in connection with this Statement of Limited Warranty is limited to the compensation of only those damages and losses proved and actually arising as an immediate and direct consequence of the non-fulfillment of such obligations (if IBM is at fault), for a maximum amount equal to the charges you paid for the Machine that has caused the damages. For purposes of this item, the term "Machine" includes Machine Code and Licensed Internal Code ("LIC").

The above limitation shall not apply to damages for bodily injuries (including death) and damages to real property and tangible personal property for which IBM is legally liable.

2. **UNDER NO CIRCUMSTANCES IS IBM, ITS SUPPLIERS OR RESELLERS LIABLE FOR ANY OF THE FOLLOWING, EVEN IF INFORMED OF THEIR POSSIBILITY: 1) LOSS OF, OR DAMAGE TO, DATA; 2) INCIDENTAL OR INDIRECT DAMAGES, OR FOR ANY ECONOMIC CONSEQUENTIAL DAMAGES; 3) LOST PROFITS, EVEN IF THEY ARISE AS AN IMMEDIATE CONSEQUENCE OF THE EVENT THAT GENERATED THE DAMAGES; OR 4) LOSS OF BUSINESS, REVENUE, GOODWILL, OR ANTICIPATED SAVINGS.**

**THE FOLLOWING TERMS APPLY TO THE COUNTRY SPECIFIED:**

### **AUSTRIA**

**What this Warranty Covers:** *The following replaces the first sentence of the first paragraph of this section:*

The warranty for an IBM Machine covers the functionality of the Machine for its normal use and the Machine's conformity to its Specifications.

*The following paragraphs are added to this Section:*

The minimum warranty period for Machines is 12 months from the date of delivery. . The limitation period for consumers in action for breach of warranty is the statutory period as a minimum. In case IBM or your reseller is unable to repair an IBM Machine, you can alternatively ask for a partial refund as far as justified by the reduced value of the unrepaired Machine or ask for a cancellation of the respective agreement for such Machine and get your money refunded.

*The second paragraph does not apply.*

**What IBM Will Do to Correct Problems:** *The following is added to this section:*

During the warranty period, transportation for delivery of the failing Machine to IBM will be at IBM's expense.

**Limitation of Liability:** *The following paragraph is added to this section:*

The limitations and exclusions specified in the Statement of Limited Warranty will not apply to damages caused by IBM with fraud or gross negligence and for express warranty.

*The following sentence is added to the end of item 2:*

IBM's liability under this item is limited to the violation of essential contractual terms in cases of ordinary negligence.

## **EGYPT**

**Limitation of Liability:** *The following replaces item 2 in this section:*

as to any other actual direct damages, IBM's liability will be limited to the total amount you paid for the Machine that is the subject of the claim. For purposes of this item, the term "Machine" includes Machine Code and Licensed Internal Code (LIC).

*Applicability of suppliers and resellers (unchanged).*

## **FRANCE**

**Limitation of Liability:** *The following replaces the second sentence of the first paragraph of this section:*

In such instances, regardless of the basis on which you are entitled to claim damages from IBM, IBM is liable for no more than: *(items 1 and 2 unchanged).*

## **GERMANY**

**What this Warranty Covers:** *The following replaces the first sentence of the first paragraph of this section:*

The warranty for an IBM Machine covers the functionality of the Machine for its normal use and the Machine's conformity to its Specifications.

*The following paragraphs are added to this section:*

The minimum warranty period for Machines is twelve months. In case IBM or your reseller is unable to repair an IBM Machine, you can alternatively ask for a partial refund as far as justified by the reduced value of the unrepaired Machine or ask for a cancellation of the respective agreement for such Machine and get your money refunded.

*The second paragraph does not apply.*

**What IBM Will Do to Correct Problems:** *The following is added to this section:*

During the warranty period, transportation for delivery of the failing Machine to IBM will be at IBM's expense.

**Limitation of Liability:** *The following paragraph is added to this section:*

The limitations and exclusions specified in the Statement of Limited Warranty will not apply to damages caused by IBM with fraud or gross negligence and for express warranty.

*The following sentence is added to the end of item 2:*

IBM's liability under this item is limited to the violation of essential contractual terms in cases of ordinary negligence.

## **HUNGARY**

**Limitation of Liability:** *The following is added at the end of this section:*

The limitation and exclusion specified herein shall not apply to liability for a breach of contract damaging life, physical well-being, or health that has been caused intentionally, by gross negligence, or by a criminal act.

The parties accept the limitations of liability as valid provisions and state that the Section 314.(2) of the Hungarian Civil Code applies as the acquisition price as well as other advantages arising out of the present Statement of Limited Warranty balance this limitation of liability.

## **IRELAND**

**What this Warranty Covers:** *The following is added to this section:*

Except as expressly provided in these terms and conditions, all statutory conditions, including all warranties implied, but without prejudice to the generality of the foregoing all warranties implied by the Sale of Goods Act 1893 or the Sale of Goods and Supply of Services Act 1980 are hereby excluded.

**Limitation of Liability:** *The following replaces the terms of this section in its entirety:*

For the purposes of this section, a "Default" means any act, statement, omission, or negligence on the part of IBM in connection with, or in relation to, the subject matter of this Statement of Limited Warranty in respect of which IBM is legally liable to you, whether in contract or tort. A number of Defaults which together result in, or contribute to, substantially the same loss or damage will be treated as one Default occurring on the date of occurrence of the last such Default.

Circumstances may arise where, because of a Default, you are entitled to recover damages from IBM.

This section sets out the extent of IBM's liability and your sole remedy.

1. IBM will accept unlimited liability for death or personal injury caused by the negligence of IBM.
2. Subject always to the Items for Which IBM is Not Liable below, IBM will accept unlimited liability for physical damage to your tangible property resulting from the negligence of IBM.
3. Except as provided in items 1 and 2 above, IBM's entire liability for actual damages for any one Default will not in any event exceed the greater of 1) EUR 125,000, or 2) 125% of the amount you paid for the Machine directly relating to the Default.

## **Items for Which IBM is Not Liable**

Save with respect to any liability referred to in item 1 above, under no circumstances is IBM, its suppliers or resellers liable for any of the following, even if IBM or they were informed of the possibility of such losses:

1. loss of, or damage to, data;
2. special, indirect, or consequential loss; or
3. loss of profits, business, revenue, goodwill, or anticipated savings.

## **SLOVAKIA**

**Limitation of Liability:** *The following is added to the end of the last paragraph:*

The limitations apply to the extent they are not prohibited under §§ 373-386 of the Slovak Commercial Code.

## **SOUTH AFRICA, NAMIBIA, BOTSWANA, LESOTHO AND SWAZILAND**

**Limitation of Liability:** *The following is added to this section:*

IBM's entire liability to you for actual damages arising in all situations involving nonperformance by IBM in respect of the subject matter of this Statement of Warranty will be limited to the charge paid by you for the individual Machine that is the subject of your claim from IBM.

## **UNITED KINGDOM**

**Limitation of Liability:** *The following replaces the terms of this section in its entirety:*

For the purposes of this section, a "Default" means any act, statement, omission, or negligence on the part of IBM in connection with, or in relation to, the subject matter of this Statement of Limited Warranty in respect of which IBM is legally liable to you, whether in contract or tort. A number of Defaults which together result in, or contribute to, substantially the same loss or damage will be treated as one Default.

Circumstances may arise where, because of a Default, you are entitled to recover damages from IBM.

This section sets out the extent of IBM's liability and your sole remedy.

1. IBM will accept unlimited liability for:
  - a. death or personal injury caused by the negligence of IBM; and
  - b. any breach of its obligations implied by Section 12 of the Sale of Goods Act 1979 or Section 2 of the Supply of Goods and Services Act 1982, or any statutory modification or re-enactment of either such Section.
2. IBM will accept unlimited liability, subject always to the Items for Which IBM is Not Liable below, for physical damage to your tangible property resulting from the negligence of IBM.

3. IBM's entire liability for actual damages for any one Default will not in any event, except as provided in items 1 and 2 above, exceed the greater of 1) Pounds Sterling 75,000, or 2) 125% of the total purchase price payable or the charges for the Machine directly relating to the Default.

These limits also apply to IBM's suppliers and resellers. They state the maximum for which IBM and such suppliers and resellers are collectively responsible.

#### **Items for Which IBM is Not Liable**

Save with respect to any liability referred to in item 1 above, under no circumstances is IBM or any of its suppliers or resellers liable for any of the following, even if IBM or they were informed of the possibility of such losses:

1. loss of, or damage to, data:
2. special, indirect, or consequential loss; or
3. loss of profits, business, revenue, goodwill, or anticipated savings.

---

## **Part 3 - Warranty Information**

This Part 3 provides information regarding the warranty applicable to your Machine, including the warranty period and type of warranty service IBM provides.

#### **Warranty Period**

The warranty period may vary by country or region and is specified in the table below. NOTE: "Region" means either Hong Kong or Macau Special Administrative Region of China.

#### **48X/32X/48X/16X Max CD-RW/DVD-ROM Combination Drive**

<b>Country or Region of Purchase</b>	<b>Warranty Period</b>	<b>Type of Warranty Service</b>
Worldwide	1 year	1, 4

A warranty period of 1 year on parts and 1 year on labor means that IBM provides warranty service without charge for parts and labor during the 1 year warranty period.

#### **Types of Warranty Service**

If required, IBM provides repair or exchange service depending on the type of warranty service specified for your Machine in the above table and as described below. Warranty service may be provided by your reseller if approved by IBM to perform warranty service. Scheduling of service will depend upon the time of your call and is subject to parts availability. Service levels are response time objectives and are not guaranteed. The specified level of warranty service may not be available in all worldwide locations, additional charges may apply outside IBM's normal service area, contact your local IBM representative or your reseller for country and location specific information.

#### **1. Customer Replaceable Unit ("CRU") Service**



IBM will ship CRU parts to you for your replacement. If IBM instructs you to return the replaced CRU, you are responsible for returning it to IBM in accordance with IBM's instructions. If you do not return the defective CRU, if IBM so instructs, within 30 days of your receipt of the replacement CRU, IBM may charge you for the replacement.

## 2. On-site Service

IBM or your reseller will either repair or exchange the failing Machine at your location and verify its operation. You must provide suitable working area to allow disassembly and reassembly of the IBM Machine. The area must be clean, well lit and suitable for the purpose. **For some Machines, certain repairs may require sending the Machine to an IBM service center.**

## 3. Courier or Depot Service<sup>1</sup>

You will disconnect the failing Machine for collection arranged by IBM. IBM will provide you with a shipping container for you to return your Machine to a designated service center. A courier will pick up your Machine and deliver it to the designated service center. Following its repair or exchange, IBM will arrange the return delivery of the Machine to your location. You are responsible for its installation and verification.

## 4. Customer Carry-In or Mail-In Service

You will deliver or mail as IBM specifies (prepaid unless IBM specifies otherwise) the failing Machine suitably packaged to a location IBM designates. After IBM has repaired or exchanged the Machine, IBM will make it available for your collection or, for Mail-in Service, IBM will return it to you at IBM's expense, unless IBM specifies otherwise. You are responsible for the subsequent installation and verification of the Machine.

The IBM Machine Warranty worldwide web site at [http://www.ibm.com/servers/support/machine\\_warranties/](http://www.ibm.com/servers/support/machine_warranties/) provides a worldwide overview of IBM's Limited Warranty for Machines, a Glossary of IBM definitions, Frequently Asked Questions (FAQs) and Support by Product (Machine) with links to Product Support pages. **The IBM Statement of Limited Warranty is also available on this site in 29 languages.**

To obtain warranty service contact IBM or your IBM reseller. In Canada or the United States, call 1-800-IBM-SERV (426-7378). For other countries, see the telephone numbers below.

Phone numbers are subject to change without notice. For the latest phone number list, go to [www-3.ibm.com/pc/support/site.wss/](http://www-3.ibm.com/pc/support/site.wss/) and click **Support Phone List**.

Country or Region	Telephone Number	Country or Region	Telephone Number
Argentina	0800-666-0011	Malaysia	03-7727-7800
Australia	1300-130-426	Mexico	001-866-434-2080
Austria	01-24592-5901	Netherlands	020-514-5770

---

1. This type of service is called ThinkPad EasyServ or EasyServ in some countries.

Country or Region	Telephone Number	Country or Region	Telephone Number
Belgium	Dutch 02-210-9820	New Zealand	0800-446-149
	French 02-210-9800		
Bolivia	0800-0189	Norway	66 81 11 00
Brazil	55-11-3889-8986	Peru	0-800-50-866
Canada	1-800-565-3344	Philippines	632-995-2225
	Toronto 416-383-3344		
Chile	800-224-488	Portugal	21-791 51 47
China (PRC)	800-810-1818	Russia	095-940-2000
China (Hong Kong S.A.R.)	852-2825-7799	Singapore	1800-840-9911
Columbia	980-912-3021	Spain	91-662 49 16
Denmark	45 20 82 00	Sweden	08-477 4420
Ecuador	1-800-426911 (option #4)	Switzerland	058-333-09-00
Finland	09-459 69 60	Taiwan	886-2-2725-9799
France	02 38 55 74 50	Thailand	66-2-273-4000
Germany	07032-1549 201	Turkey	00-800-446-32-041
Indonesia	021-523-8535	United Kingdom	0-1475-555 055
Ireland	01-815-9202	United States	1-800-426-7378
Italy	02-7031-6101	Uruguay	000-411-005-6649
Japan	Consumer customers 0120-887-870	Venezuela	0-800-100-2011
	Business customers 0120-887-874		
Luxembourg	298-977 5063	Vietnam	848-8295-160

---

## 附录 G. Notices

---

### Federal Communications Commission (FCC) statement

**Note:** This equipment has been tested and found to comply with the limits for a Class B digital device, pursuant to Part 15 of the FCC Rules. These limits are designed to provide reasonable protection against harmful interference in a residential installation. This equipment generates, uses, and can radiate radio frequency energy and, if not installed and used in accordance with the instructions, may cause harmful interference to radio communications. However, there is no guarantee that interference will not occur in a particular installation. If this equipment does cause harmful interference to radio or television reception, which can be determined by turning the equipment off and on, the user is encouraged to try to correct the interference by one or more of the following measures:

- Reorient or relocate the receiving antenna.
- Increase the separation between the equipment and receiver.
- Connect the equipment into an outlet on a circuit different from that to which the receiver is connected.
- Consult an IBM authorized dealer or service representative for help.

Properly shielded and grounded cables and connectors must be used in order to meet FCC emission limits. Proper cables and connectors are available from IBM authorized dealers. IBM is not responsible for any radio or television interference caused by using other than recommended cables and connectors or by unauthorized changes or modifications to this equipment. Unauthorized changes or modifications could void the user's authority to operate the equipment.

This device complies with Part 15 of the FCC Rules. Operation is subject to the following two conditions: (1) this device may not cause harmful interference, and (2) this device must accept any interference received, including interference that may cause undesired operation.

Responsible party:

International Business Machines Corporation  
New Orchard Road  
Armonk, NY 10504  
Telephone: 1-919-543-2193

 Tested To Comply  
With FCC Standards  
FOR HOME OR OFFICE USE

### Industry Canada Class B emission compliance statement

This Class B digital apparatus complies with Canadian ICES-003.

## **Avis de conformite a la reglementation d'Industrie Canada**

Cet appareil numérique de la classe B est conforme à la norme NMB-003 du Canada.

## **Deutsche EMV-Direktive (electromagnetische Verträglichkeit)**

Zulassungbescheinigung laut dem Deutschen Gesetz über die elektromagnetische Verträglichkeit von Geräten (EMVG) vom 30. August 1995 (bzw. der EMC EG Richtlinie 89/336):

Dieses Gerät ist berechtigt in Übereinstimmung mit dem Deutschen EMVG das EG-Konformitätszeichen - CE - zu führen. Verantwortlich für die Konformitätserklärung nach Paragraph 5 des EMVG ist die:

IBM Deutschland Informationssysteme GmbH, 70548 Stuttgart.

Informationen in Hinsicht EMVG Paragraph 3 Abs. (2) 2:

Das Gerät erfüllt die Schutzanforderungen nach EN 55024:1998 und EN 55022:1998 Klasse B.
--

EN 55022 Hinweis:

☞ Wird dieses Gerät in einer industriellen Umgebung betrieben (wie in EN 55022:B festgelegt), dann kann es dabei eventuell gestört werden. In solch einem Fall ist der Abstand bzw. die Abschirmung zu der industriellen Störquelle zu vergrößern. ☞

Anmerkung:

Um die Einhaltung des EMVG sicherzustellen sind die Geräte, wie in den IBM Handbüchern angegeben, zu installieren und zu betreiben.

## **European Union - emission directive**

This product is in conformity with the protection requirements of EU Council Directive 89/336/ECC on the approximation of the laws of the Member States relating to electromagnetic compatibility.

IBM can not accept responsibility for any failure to satisfy the protection requirements resulting from a non-recommended modification of the product, including the fitting of non-IBM option cards.

This product has been tested and found to comply with the limits for Class B Information Technology Equipment according to European Standard EN 55022. The limits for Class B equipment were derived for typical residential environments to provide reasonable protection against interference with licensed communication devices.

## **Union Européenne - Directive Conformité électromagnétique**

Ce produit est conforme aux exigences de protection de la Directive 89/336/EEC du Conseil de l'UE sur le rapprochement des lois des États membres en matière de compatibilité électromagnétique.

IBM ne peut accepter aucune responsabilité pour le manquement aux exigences de protection résultant d'une modification non recommandée du produit, y compris l'installation de cartes autres que les cartes IBM.

Ce produit a été testé et il satisfait les conditions de l'équipement informatique de Classe B en vertu de Standard européen EN 55022. Les conditions pour l'équipement de Classe B ont été définies en fonction d'un contexte résidentiel ordinaire afin de fournir une protection raisonnable contre l'interférence d'appareils de communication autorisés.

### **Unione Europea - Directiva EMC (Conformidad electromagnética)**

Este producto satisface los requisitos de protección del Consejo de la UE, Directiva 89/336/CEE en lo que a la legislatura de los Estados Miembros sobre compatibilidad electromagnética se refiere.

IBM no puede aceptar responsabilidad alguna si este producto deja de satisfacer dichos requisitos de protección como resultado de una modificación no recomendada del producto, incluyendo el ajuste de tarjetas de opción que no sean IBM.

Este producto ha sido probado y satisface los límites para Equipos Informáticos Clase B de conformidad con el Estándar Europeo EN 55022. Los límites para los equipos de Clase B se han establecido para entornos residenciales típicos a fin de proporcionar una protección razonable contra las interferencias con dispositivos de comunicación licenciados.

### **Union Europea - Normativa EMC**

Questo prodotto è conforme alle normative di protezione ai sensi della Direttiva del Consiglio dell'Unione Europea 89/336/CEE sull'armonizzazione legislativa degli stati membri in materia di compatibilità elettromagnetica.

IBM non accetta responsabilità alcuna per la mancata conformità alle normative di protezione dovuta a modifiche non consigliate al prodotto, compresa l'installazione di schede e componenti di marca diversa da IBM.

Le prove effettuate sul presente prodotto hanno accertato che esso rientra nei limiti stabiliti per le apparecchiature di informatica Classe B ai sensi della Norma Europea EN 55022. I limiti delle apparecchiature della Classe B sono stati stabiliti al fine di fornire ragionevole protezione da interferenze mediante dispositivi di comunicazione in concessione in ambienti residenziali tipici.

이 기기는 가정용으로 전자파 적합등록을 한 기기로서  
주거지역에서는 물론 모든 지역에서 사용할 수 있습니다.

この装置は、情報処理装置等電波障害自主規制協議会（VCCI）の基準に基づくクラスB情報技術装置です。この装置は、家庭環境で使用することを目的としていますが、この装置がラジオやテレビジョン受信機に近接して使用されると、受信障害を引き起こすことがあります。  
取扱説明書に従って正しい取り扱いをして下さい。

**Japanese statement of compliance for products less than or equal to 20 A per phase**

## 高調波ガイドライン適合品

---

### Trademarks

The following terms are trademarks of International Business Machines Corporation in the United States, other countries, or both:

IBM

IBM logo

Intel and Pentium are trademarks of Intel Corporation in the United States, other countries, or both.

Microsoft, Windows, and Windows NT are trademarks of Microsoft Corporation in the United States, other countries, or both.

Other company, product, or service names may be trademarks or service marks of others.

---

### Electronic emission notices

**Machine** - 48X/32X/48X/16X Max CD-RW/DVD-ROM Combination Drive

### Federal Communications Commission (FCC) statement

**Note:** This equipment has been tested and found to comply with the limits for a Class B digital device, pursuant to Part 15 of the FCC Rules. These limits are designed to provide reasonable protection against harmful interference when the equipment is operated in a commercial environment. This equipment generates, uses, and can radiate radio frequency energy and, if not installed and used in accordance with the instruction manual, may cause harmful interference to radio communications. Operation of this equipment in a residential area is likely to cause harmful interference, in which case the user will be required to correct the interference at his own expense.

Properly shielded and grounded cables and connectors must be used in order to meet FCC emission limits. IBM is not responsible for any radio or television interference caused by using other than recommended cables and connectors or by unauthorized changes or modifications to this equipment. Unauthorized changes or modifications could void the user's authority to operate the equipment.

This device complies with Part 15 of the FCC Rules. Operation is subject to the following two conditions: (1) this device may not cause harmful interference, and (2) this device must accept any interference received, including interference that may cause undesired operation.

### Industry Canada Class B emission compliance statement

This Class B digital apparatus complies with Canadian ICES-003.

## **Avis de conformite a la reglementation d'Industrie Canada**

Cet appareil numérique de la classe A est conform à la norme NMB-003 du Canada.

## **Deutsche EMV-Direktive (electromagnetische Verträglichkeit)**

Dieses Gerät ist berechtigt in Übereinstimmung mit dem deutschen EMVG vom 9.Nov.92 das EG-Konformitätszeichen zu führen.

Der Aussteller der Konformitätserklärung ist die IBM UK, Greenock.

Dieses Gerät erfüllt die Bedingungen der EN 55022 Klasse A. Für diese Klasse von Geräten gilt folgende Bestimmung nach dem EMVG:

Geräte dürfen an Orten, für die sie nicht ausreichend entstört sind, nur mit besonderer Genehmigung des Bundesministers für Post und Telekommunikation oder des Bundesamtes für Post und Telekommunikation betrieben werden. Die Genehmigung wird erteilt, wenn keine elektromagnetischen Störungen zu erwarten sind.

(Auszug aus dem EMVG vom 9.Nov.92, Para.3. Abs.4)

**Hinweis:** Dieses Genehmigungsverfahren ist von der Deutschen Bundespost noch nicht veröffentlicht worden.

## **European Union - EMC directive**

This product is in conformity with the protection requirements of EU Council Directive 89/336/ECC on the approximation of the laws of the Member States relating to electromagnetic compatibility.

IBM cannot accept responsibility for any failure to satisfy the protection requirements resulting from a non-recommended modification of the product, including the fitting of non-IBM option cards.

This product has been tested and found to comply with the limits for Class B Information Technology Equipment according to CISPR 22/European Standard EN 55022. The limits for Class B equipment were derived for commercial and industrial environments to provide reasonable protection against interference with licensed communication equipment.

**Warning:** This is a Class B product. In a domestic environment this product may cause radio interference in which case the user may be required to take adequate measures.

## **Union Européenne - Directive Conformité électromagnétique**

Ce produit est conforme aux exigences de protection de la Directive 89/336/EEC du Conseil de l'UE sur le rapprochement des lois des États membres en matière de compatibilité électromagnétique.

IBM ne peut accepter aucune responsabilité pour le manquement aux exigences de protection résultant d'une modification non recommandée du produit, y compris l'installation de cartes autres que les cartes IBM.

Ce produit a été testé et il satisfait les conditions de l'équipement informatique de Classe A en vertu de CISPR22/Standard européen EN 55022. Les conditions pour l'équipement de Classe A ont été définies en fonction d'un contexte d'utilisation commercial et industriel afin de fournir une protection raisonnable contre l'interférence d'appareils de communication autorisés.

**Avvertissement :** Ceci est un produit de Classe A. Dans un contexte résidentiel, ce produit peut causer une interférence radio exigeant que l'utilisateur prenne des mesures adéquates.

### Union Europea - Normativa EMC

Questo prodotto è conforme alle normative di protezione ai sensi della Direttiva del Consiglio dell'Unione Europea 89/336/CEE sull'armonizzazione legislativa degli stati membri in materia di compatibilità elettromagnetica.

IBM non accetta responsabilità alcuna per la mancata conformità alle normative di protezione dovuta a modifiche non consigliate al prodotto, compresa l'installazione di schede e componenti di marca diversa da IBM.

Le prove effettuate sul presente prodotto hanno accertato che esso rientra nei limiti stabiliti per le apparecchiature di informatica Classe A ai sensi del CISPR 22/Norma Europea EN 55022. I limiti delle apparecchiature della Classe A sono stati stabiliti al fine di fornire ragionevole protezione da interferenze mediante dispositivi di comunicazione in concessione in ambienti commerciali ed industriali.

**Avvertimento:** Questo è un prodotto appartenente alla Classe A. In ambiente domestico, tale prodotto può essere causa di interferenze radio, nel qual caso l'utente deve prendere misure adeguate.

### Unione Europea - Directiva EMC (Conformidad electromagnética)

Este producto satisface los requisitos de protección del Consejo de la UE, Directiva 89/336/CEE en lo que a la legislatura de los Estados Miembros sobre compatibilidad electromagnética se refiere.

IBM no puede aceptar responsabilidad alguna si este producto deja de satisfacer dichos requisitos de protección como resultado de una modificación no recomendada del producto, incluyendo el ajuste de tarjetas de opción que no sean IBM.

Este producto ha sido probado y satisface los límites para Equipos Informáticos Clase A de conformidad con el Estándar CISPR22 y el Estándar Europeo EN 55022. Los límites para los equipos de Clase A se han establecido para entornos comerciales e industriales a fin de proporcionar una protección razonable contra las interferencias con dispositivos de comunicación licenciados.

**Advertencia:** Este es un producto de Clase A. En un entorno doméstico este producto podría causar radiointerferencias en cuyo caso el usuario deberá tomar las medidas adecuadas.



この装置は、情報処理装置等電波障害自主規制協議会（VCCI）の基準に基づきクラスA情報技術装置です。この装置を家庭環境で使用すると電波妨害を引き起こすことがあります。この場合には使用者が適切な対策を講ずるよう要求されることがあります。

警告使用者：  
這是甲類的資訊產品，在居住的環境中使用時，可能會造成射頻干擾，在這種情況下，使用者會被要求採取某些適當的對策。



部件号： 73P3304

Printed in China

(1P) P/N: 73P3304

