



**@server**

xSeries 300

## User's Reference





xSeries 300



# User's Reference

**Note:**

Before using this information and the product it supports, be sure to read the general information in Appendix A, "Product warranties and notices," on page 101.

**First Edition (June 2001)**

**© Copyright International Business Machines Corporation 2001. All rights reserved.**

US Government Users Restricted Rights – Use, duplication or disclosure restricted by GSA ADP Schedule Contract with IBM Corp.

# Contents

<b>Safety</b> .....	vii
<b>Chapter 1. Introducing the IBM xSeries 300</b> .....	1
Features and specifications .....	2
Notices and statements used in this book .....	3
What your IBM xSeries 300 offers .....	4
Reliability, availability, and serviceability features .....	5
Server controls and indicators .....	6
Front view .....	6
Rear view .....	7
Turning on the server .....	8
Turning off the server .....	8
Standby mode .....	9
<b>Chapter 2. Arranging your workspace</b> .....	11
Comfort .....	11
Glare and lighting .....	11
Air circulation .....	12
Electrical outlets and cable lengths .....	12
<b>Chapter 3. Configuring your server</b> .....	13
Using the Configuration/Setup Utility program .....	13
Starting the Configuration/Setup Utility program .....	13
Choices available from the Configuration/Setup main menu .....	14
Using passwords .....	16
Using the SCSISelect utility program (some models) .....	16
Starting the SCSISelect utility program .....	16
Choices available from the SCSISelect menu .....	17
Using the PXE boot agent utility program .....	18
Starting the PXE boot agent utility program .....	18
Choices available from the PXE boot agent utility .....	18
<b>Chapter 4. Using the ServerGuide CDs</b> .....	21
Features at a glance .....	22
Setup and configuration overview .....	23
System Partition .....	24
Typical NOS installation .....	24
Setting up or updating multiple servers .....	24
Installing your NOS without ServerGuide .....	25
Additional programs included with ServerGuide .....	25
Error symptoms .....	25
<b>Chapter 5. Installing options</b> .....	27
Major components of the xSeries 300 .....	27
System board internal cable connectors .....	28
System board jumpers .....	29
Before you begin .....	29
System reliability considerations .....	30
Handling static-sensitive devices .....	30
Safety Information .....	31
Removing the cover .....	37
Working with adapters .....	38
Adapter considerations .....	39
Installing an adapter .....	39

Hard disk drives . . . . .	42
Installing or replacing a hard disk drive . . . . .	42
Installing DIMMs . . . . .	43
Replacing the fan assembly . . . . .	45
Installing the cover . . . . .	46
I/O connectors . . . . .	47
Serial port . . . . .	47
Viewing or changing the serial-port assignments . . . . .	47
Serial-port connector . . . . .	48
Universal Serial Bus ports . . . . .	48
USB cables and hubs . . . . .	48
USB-port connectors . . . . .	49
Keyboard connector . . . . .	49
Video connector . . . . .	50
Auxiliary-device (pointing device) connector . . . . .	50
Ethernet ports . . . . .	51
Configuring the Ethernet controllers . . . . .	51
Failover for redundant Ethernet . . . . .	51
High Performance Ethernet Modes . . . . .	52
Ethernet port connector . . . . .	54
<b>Chapter 6.Solving problems . . . . .</b>	<b>55</b>
Diagnostic tools overview . . . . .	55
POST . . . . .	57
POST beep code descriptions . . . . .	57
POST error messages . . . . .	60
Small computer system interface messages (some models) . . . . .	68
Diagnostic programs and error messages . . . . .	68
Text messages . . . . .	69
Starting the diagnostic programs . . . . .	69
Using the diagnostics CD . . . . .	70
Downloading the diagnostics program . . . . .	70
Using the diagnostic diskette . . . . .	70
Viewing the test log . . . . .	71
Diagnostic error message tables . . . . .	72
Recovering BIOS code . . . . .	78
Clearing CMOS . . . . .	79
Troubleshooting charts . . . . .	79
Troubleshooting the Ethernet controller . . . . .	83
Network connection problems . . . . .	83
Ethernet controller troubleshooting chart . . . . .	85
Ethernet controller messages . . . . .	86
Novell NetWare or IntraNetWare system ODI driver teaming messages . . . . .	86
NDIS 4.0 (Windows NT) driver messages . . . . .	87
Ethernet teaming messages . . . . .	90
Replacing the battery . . . . .	92
Getting help, service, and information . . . . .	93
Service support . . . . .	94
Before you call for service . . . . .	94
Getting customer support and service . . . . .	95
Using the World Wide Web . . . . .	95
Using electronic support services . . . . .	95
Getting information by fax . . . . .	95
Getting help online . . . . .	96
Getting help by telephone . . . . .	96
Getting help around the world . . . . .	97

Purchasing additional services . . . . .	97
Enhanced PC support line . . . . .	98
900-number operating system and hardware support line . . . . .	98
Network and system support line . . . . .	98
Ordering support line services . . . . .	98
Warranty and repair services . . . . .	99
Ordering publications . . . . .	99
<b>Appendix A. Product warranties and notices . . . . .</b>	<b>101</b>
Warranty Information . . . . .	101
Warranty Period . . . . .	101
IBM Statement of Limited Warranty . . . . .	101
Part 1 - General Terms . . . . .	101
Part 2 - Country-unique Terms . . . . .	104
Notices . . . . .	109
Edition notice . . . . .	110
Processing date data . . . . .	110
Trademarks . . . . .	110
Important notes . . . . .	111
Electronic emission notices . . . . .	111
Federal Communications Commission (FCC) Statement . . . . .	111
Industry Canada Class A emission compliance statement . . . . .	111
Australia and New Zealand Class A statement . . . . .	112
United Kingdom telecommunications safety requirement . . . . .	112
European Union EMC Directive conformance statement . . . . .	112
Taiwan electrical emission statement . . . . .	112
Japanese Voluntary Control Council for Interference (VCCI) statement . . . . .	113
Power cords . . . . .	113
<b>Index . . . . .</b>	<b>115</b>





# Safety

Before installing this product, read the Safety Information.

مج، يجب قراءة دات السلامة

Antes de instalar este produto, leia as Informações de Segurança.

在安装本产品之前，请仔细阅读 **Safety Information** (安全信息)。

安裝本產品之前，請先閱讀「安全資訊」。

Prije instalacije ovog produkta obavezno pročitajte Sigurnosne Upute.

Před instalací tohoto produktu si přečtěte příručku bezpečnostních instrukcí.

Læs sikkerhedsforskrifterne, før du installerer dette produkt.

Lees voordat u dit product installeert eerst de veiligheidsvoorschriften.

Ennen kuin asennat tämän tuotteen, lue turvaohjeet kohdasta Safety Information.

Avant d'installer ce produit, lisez les consignes de sécurité.

Vor der Installation dieses Produkts die Sicherheitshinweise lesen.

Πριν εγκαταστήσετε το προϊόν αυτό, διαβάστε τις πληροφορίες ασφάλειας (safety information).

לפני שתתקינו מוצר זה, קראו את הוראות הבטיחות.

A termék telepítése előtt olvassa el a Biztonsági előírásokat!

Prima di installare questo prodotto, leggere le Informazioni sulla Sicurezza

製品の設置の前に、安全情報をお読みください。

본 제품을 설치하기 전에 안전 정보를 읽으십시오.

Пред да се инсталира овој продукт, прочитајте информацијата за безбедност.

Les sikkerhetsinformasjonen (Safety Information) før du installerer dette produktet.

Przed zainstalowaniem tego produktu, należy zapoznać się z książką "Informacje dotyczące bezpieczeństwa" (Safety Information).

Antes de instalar este produto, leia as Informações sobre Segurança.

Перед установкой продукта прочтите инструкции по технике безопасности.

Pred inštaláciou tohto zariadenia si pečítajte Bezpečnostné predpisy.

Pred namestitvijo tega proizvoda preberite Varnostne informacije.

Antes de instalar este producto lea la información de seguridad.

Läs säkerhetsinformationen innan du installerar den här produkten.

Statement 1



**DANGER**

**Electrical current from power, telephone, and communication cables is hazardous.**

**To avoid a shock hazard:**

- **Do not connect or disconnect any cables or perform installation, maintenance, or reconfiguration of this product during an electrical storm.**
- **Connect all power cords to a properly wired and grounded electrical outlet.**
- **Connect to properly wired outlets any equipment that will be attached to this product.**
- **When possible, use one hand only to connect or disconnect signal cables.**
- **Never turn on any equipment when there is evidence of fire, water, or structural damage.**
- **Disconnect the attached power cords, telecommunications systems, networks, and modems before you open the device covers, unless instructed otherwise in the installation and configuration procedures.**
- **Connect and disconnect cables as described in the following table when installing, moving, or opening covers on this product or attached devices.**

To connect:

1. Turn everything OFF.
2. First, attach all cables to devices.
3. Attach signal cables to connectors.
4. Attach power cords to outlet.
5. Turn device ON.

To disconnect:

1. Turn everything OFF.
2. First, remove power cords from outlet.
3. Remove signal cables from connectors.
4. Remove all cables from devices.

## Statement 2

### CAUTION:



When replacing the lithium battery, use only IBM Part Number 33F8354 or an equivalent type battery recommended by the manufacturer. If your system has a module containing a lithium battery, replace it only with the same module type made by the same manufacturer. The battery contains lithium and can explode if not properly used, handled, or disposed of.

#### Do not:

- Throw or immerse into water.
- Heat to more than 100 C (212 F)
- Repair or disassemble

Dispose of the battery as required by local ordinances or regulations.

## Statement 3



### CAUTION:

When laser products (such as CD-ROMs, DVD drives, fiber optic devices, or transmitters) are installed, note the following:

- Do not remove the covers. Removing the covers of the laser product could result in exposure to hazardous laser radiation. There are no serviceable parts inside the device.
- Use of controls or adjustments or performance of procedures other than those specified herein might result in hazardous radiation exposure.



### DANGER

Some laser products contain an embedded Class 3A or Class 3B laser diode. Note the following. Laser radiation when open. Do not stare into the beam, do not view directly with optical instruments, and avoid direct exposure to the beam.

Statement 4

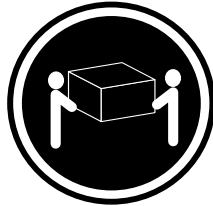

≥18 kg (39.7 lbs)

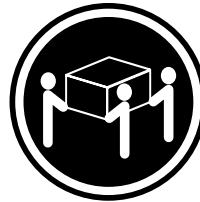

≥32 kg (70.5 lbs)

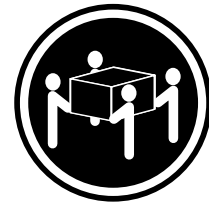

≥55 kg (121.2 lbs)

**CAUTION:**

Use safe practices when lifting.

Statement 5



**CAUTION:**

The power control button on the device and the power switch on the power supply do not turn off the electrical current supplied to the device. The device also might have more than one power cord. To remove all electrical current from the device, ensure that all power cords are disconnected from the power source.

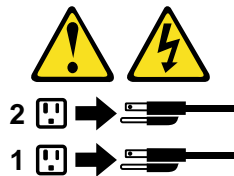

**Statement 8**



**CAUTION:**

**Never remove the cover on a power supply or any part that has the following label attached.**



**Hazardous voltage, current, and energy levels are present inside any component that has this label attached. There are no serviceable parts inside these components. If you suspect a problem with one of these parts, contact a service technician.**

## Chapter 1. Introducing the IBM xSeries 300

Your IBM® eServer xSeries 300 is a one U-high<sup>1</sup> rack model server for high-volume network transaction processing. This high-performance server is ideally suited for networking environments that require superior microprocessor performance, efficient memory management, flexibility, and reliable data storage.

Your xSeries 300 server comes with a limited warranty and IBM Start Up Support. If you have access to the World Wide Web, you can obtain up-to-date information about your xSeries 300 model and other IBM server products at the following World Wide Web address: <http://www.ibm.com/eserver/xseries>.

For service, assistance, or additional information on IBM Server Start Up Support and the World Wide Web, see "Getting help, service, and information" on page 93.

The machine type and serial number are located on the ID label located just behind the bezel on the right of the server. You will need these numbers when you register your server with IBM.

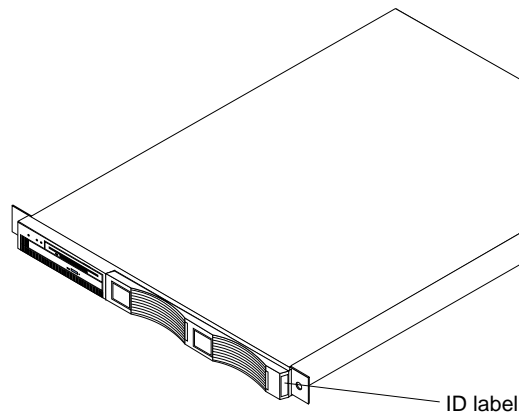

---

1. Racks are marked in vertical increments of 1.75 inches each. Each increment is referred to as a unit, or "U." A one-U-high device is 1.75 inches-tall.

## Features and specifications

The following table provides a summary of the features and specifications for your xSeries 300.

<p><b>Microprocessor:</b></p> <p>Supports either of the two listed microprocessors (depending on your model)</p> <ul style="list-style-type: none"> <li>One Intel® Pentium® III with 256 KB* Level-2 cache and MMX™ (MMX2) technology</li> <li>or</li> <li>One Intel Celeron™ with 128 KB Level-2 cache and MMX (MMX2) technology</li> </ul> <p><b>Memory:</b></p> <ul style="list-style-type: none"> <li>Minimum: 128 MB*</li> <li>Maximum: 1.5 GB*</li> <li>Type: PC133 MHz, ECC SDRAM, unregistered DIMMs only</li> <li>Slots: Three dual inline</li> <li>Supports 128, 256, and 512 MB DIMMs</li> </ul> <p><b>Drives:</b></p> <ul style="list-style-type: none"> <li>Diskette: 1.44 MB</li> <li>CD-ROM: 24X IDE</li> <li>Supports up to two hard disk drives</li> </ul> <p><b>Expansion bays:</b></p> <p>Two 3.5-in. slim-high bays for hard disk drives</p> <p><b>PCI expansion slots:</b></p> <p>Two 33 MHz/32-bit on the system board</p> <p><b>Power supply:</b></p> <p>200 watt (110 or 220 V ac auto-sensing) with Wake on LAN support</p>	<p><b>Video:</b></p> <ul style="list-style-type: none"> <li>S3 Savage 4 Pro video on system board</li> <li>Compatible with SVGA and VGA</li> <li>8 MB SDRAM video memory</li> </ul> <p><b>Size:</b></p> <ul style="list-style-type: none"> <li>Height: 4.37 cm (1.75 inches, 1U)</li> <li>Depth: 63.5 cm (25 inches)</li> <li>Width: 44 cm (17.32 inches)</li> <li>Maximum weight: 19.05 kg (42 lb) depending on your configuration</li> </ul> <p><b>Integrated functions:</b></p> <ul style="list-style-type: none"> <li>Dual 10BASE-T/100BASE-TX Ethernet controllers on the system board with Alert on LAN™ 2 support</li> <li>Serial port</li> <li>Two USB ports</li> <li>Keyboard port</li> <li>Mouse port</li> <li>Dual-channel bus mastering IDE controller</li> </ul> <p><b>Hard disk controller:</b></p> <ul style="list-style-type: none"> <li>All models-Dual-channel bus mastering IDE controller</li> <li>Some models-SCSI adapter (Adaptec Ultra160) is installed in one of the expansion-slots</li> </ul> <p><b>Acoustical noise emissions:</b></p> <ul style="list-style-type: none"> <li>Sound power, idling: 6.6 bel maximum</li> <li>Sound power, operating: 6.8 bel maximum</li> </ul>	<p><b>Environment:</b></p> <ul style="list-style-type: none"> <li>Air temperature: <ul style="list-style-type: none"> <li>Server on: 10° to 35° C (50.0° to 95.0° F). Altitude: 0 to 914 m (2998.7 ft)</li> <li>Server on: 10° to 32° C (50.0° to 89.6° F). Altitude: 914 m (2998.7 ft) to 2133 m (6998.0 ft.)</li> <li>Server off: -40° to 60° C (-104° to 140° F). Maximum altitude: 2133 m (6998.0 ft)</li> </ul> </li> <li>Humidity: <ul style="list-style-type: none"> <li>Server on: 8% to 80%</li> <li>Server off: 5% to 100%</li> </ul> </li> </ul> <p><b>Heat output:</b></p> <p>Approximate heat output in British thermal unit (Btu) per hour</p> <ul style="list-style-type: none"> <li>Minimum configuration: 171 Btu (50 watts)</li> <li>Maximum configuration: 410 Btu (120 watts)</li> </ul> <p><b>Electrical input:</b></p> <ul style="list-style-type: none"> <li>Sine-wave input (47-63 Hz) required</li> <li>Input voltage low range: <ul style="list-style-type: none"> <li>Minimum: 90 V ac</li> <li>Maximum: 137 V ac</li> </ul> </li> <li>Input voltage high range: <ul style="list-style-type: none"> <li>Minimum: 180 V ac</li> <li>Maximum: 265 V ac</li> </ul> </li> <li>Input kilovolt-amperes (kVA) approximately: <ul style="list-style-type: none"> <li>Minimum: 0.095 kVA</li> <li>Maximum: 0.213 kVA</li> </ul> </li> </ul>
--	--	---

\*KB equals approximately 1000 bytes. MB equals approximately 1000000 bytes. GB equals approximately 1000000000 bytes.



---

## Notices and statements used in this book

The Caution statements and the Danger statements also appear in the multilingual safety information book provided on the *IBM xSeries Documentation* CD. Each statement is numbered for easy reference to the corresponding statement in the safety book.

The notice and statement definitions are as follows:

- **Notes:** These notices provide important tips, guidance, or advice.
- **Important:** These notices provide information or advice that might help you avoid inconvenient or problem situations.
- **Attention:** These notices indicate possible damage to programs, devices, or data. An attention notice is placed just before the instruction or situation in which damage could occur.
- **Caution:** These statements indicate situations that can be potentially hazardous to you. A caution statement is placed just before the description of a potentially hazardous procedure step or situation.
- **Danger:** These statements indicate situations that can be potentially lethal or extremely hazardous to you. A danger statement is placed just before the description of a potentially lethal or extremely hazardous procedure step or situation.

---

## What your IBM xSeries 300 offers

The design of your server takes advantage of advancements in memory management and data storage. Your server includes:

- Impressive performance using the latest microprocessor technology.  
Your server comes with one Intel Celeron or one Pentium III microprocessor installed.
- Large system memory  
The memory bus in your server supports up to 1.5 GB of system memory. The memory controller provides error code correction (ECC) support for up to three industry-standard PC133, 3.3 V, 168-pin, 133 megahertz (MHz), unregistered, synchronous dynamic random access memory (SDRAM) dual inline memory modules (DIMMs).
- Systems-management capabilities  
See the documentation provided with your systems-management software for more information.
- Integrated network environment support  
Your server comes with two Intel Ethernet controllers on the system board. These Ethernet controllers have an interface for connecting to 10-Mbps or 100-Mbps networks. The server automatically selects between 10BASE-T and 100BASE-TX environments. The controller provides full-duplex (FDX) capability, which enables simultaneous transmission and reception of data on the Ethernet local area network (LAN). These controllers support Alert on LAN 2 technology.
- IBM *ServerGuide*™ CDs  
The *ServerGuide* CDs that are included with your server provide programs to help you set up your server and install the network operating system (NOS). The *ServerGuide* program detects the hardware options that are installed and provides the correct configuration programs and device drivers. In addition, the *ServerGuide* CDs include a variety of application programs for your server.  
For more information about the *ServerGuide* CDs, see Chapter 4, “Using the *ServerGuide* CDs,” on page 21.

---

## Reliability, availability, and serviceability features

Three of the most important features in server design are reliability, availability, and serviceability (RAS). These RAS features help to ensure the integrity of the data stored on your server; that your server is available when you want to use it; and that should a failure occur, you can easily diagnose and repair the failure with minimal inconvenience.

The following is an abbreviated list of the RAS features that your server supports.

- Reliability features
  - Boot block recovery
  - Cooling fans with speed-sensing capability
  - Customer-upgradable basic input and output system (BIOS) code
  - ECC front-side buses (FSBs) and L2 cache
  - Advanced configuration and power interface (ACPI)
  - Power-on self-test (POST)
  - SDRAM with serial presence detect (SPD)
  - Parity checking on the PCI and SCSI bus
- Availability features
  - Advanced desktop management interface (DMI) features
  - Auto-restart initial program load (IPL) power supply
  - Automatic error retry or recovery
  - Automatic server restart
  - Automatic restart after power failure
  - Built-in, menu-driven configuration programs
  - Built-in, menu-driven setup programs
  - Failover Ethernet support
  - Menu-driven diagnostic programs on CD-ROM
  - Microsoft® Windows NT® failover support
  - Monitoring support for temperature, voltage, and fan speed
  - Server management
  - Wake on LAN® capability
- Serviceability features
  - 24 hours per day, seven days a week customer support<sup>1</sup>
  - Adaptec 29160LP built-in self-test (BIST)
  - Alert on LAN 2
  - CD-ROM-based diagnostics
  - Diagnostic support of Ethernet controllers
  - Error codes and messages
  - Processor serial number access
  - Read-only memory (ROM) checksums
  - Standard cables present detection
  - Standby voltage for system management features and monitoring
  - System error logging
  - Vital product data (VPD) (includes information stored in nonvolatile memory for easier remote viewing)

---

1. Service availability will vary by country. Response time will vary depending on the number and nature of incoming calls.

---

## Server controls and indicators

The following section identifies the controls and indicators on the front and rear of your server.

### Front view

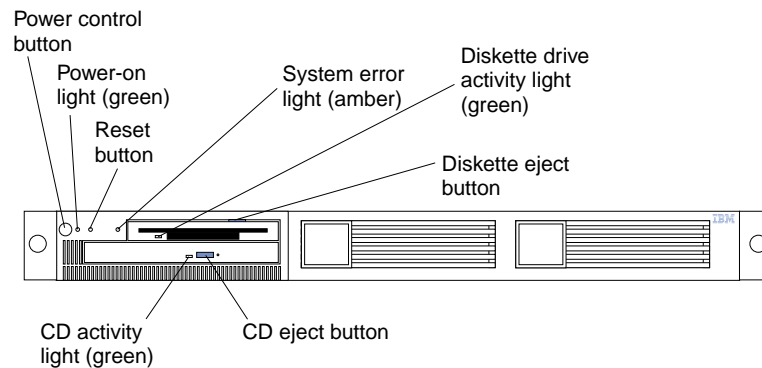

**Power-control button:** Press this button to manually turn the server on or off.

**Power-on light:** This green LED lights and stays on when you turn on your server, and it blinks when the server is in standby mode.

**Reset button:** Press this button to reset the server and run the power-on self-test (POST). You might need to use a pen or the end of a straightened paper clip to press the button.

**System-error light:** This amber LED lights when a system error occurs.

**Diskette drive activity light:** When this LED is on, it indicates that the diskette drive is in use.

**Diskette-eject button:** Push this button to release a diskette from the drive.

**CD eject button:** Push this button to release a CD from the drive.

**CD drive activity light:** When this light is on, it indicates that the CD-ROM drive is in use.

## Rear view

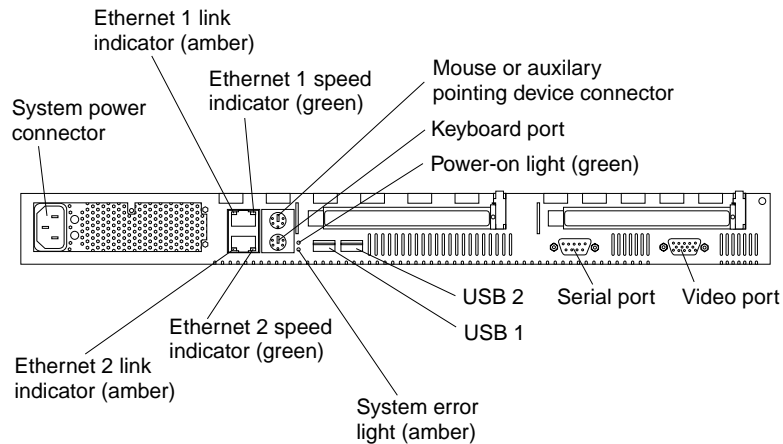

**System power connector:** The system power cord connects here to provide power to the system.

**Ethernet 1 link indicator:** This amber LED lights when there is an active link connection on the 10BASE-T or 100BASE-TX interface for Ethernet port 1.

**Ethernet 1 speed indicator:** This green LED lights when the speed of the Ethernet LAN that is connected to Ethernet port 1 is 100 Mbps.

**Auxiliary pointing device:** Signal cables for a mouse, trackball, or other pointing device connect to the Auxiliary pointing device connector.

**Keyboard port:** Signal cables for a keyboard connect to the keyboard port.

**Power-on light:** This green LED lights and stays on when you turn on your server and will blink when the server is in standby mode. This light duplicates the power on light on the front of the server.

**Video port:** The signal cable for a monitor connects to the video port.

**Serial port:** Signal cables for modems or other serial devices connect to the serial port.

**USB 2:** This is an automatically configured port that you can use to connect one or more USB devices to the server, using Plug and Play technology.

**USB 1:** This is an automatically configured port that you can use to connect one or more USB devices to the server, using Plug and Play technology.

**System-error light:** This amber LED lights when a system error occurs. This light duplicates the system error light on the front of the server.

**Ethernet 2 speed indicator:** This green LED lights when the speed of the Ethernet LAN connected to Ethernet port 2 is 100 Mbps.

**Ethernet 2 link indicator:** This amber LED lights when there is an active link connection on the 10BASE-T or 100BASE-TX interface for Ethernet port 2.

## Turning on the server

Turning on the server refers to the act of plugging the power cord of your server into the power source and starting the operating system.

Complete the following steps to turn on the server:

1. Plug the power cord of your server into the power source.

**Note:** Plugging the power cord into a power source may cause the server to start automatically. This is an acceptable action.

2. Wait 30 seconds, and then press the power control button on the front of the server.

## Turning off the server

Turning off the server refers to the act of disconnecting the server from the power source.

Complete the following steps to turn off the server:

1. Refer to your operating system documentation for the proper procedure to shut down the operating system.

### Statement 5



### CAUTION:

The power control button on the device and the power switch on the power supply do not turn off the electrical current supplied to the device. The device also might have more than one power cord. To remove all electrical current from the device, ensure that all power cords are disconnected from the power source.

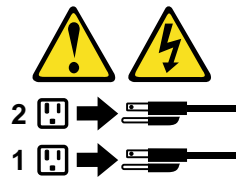

2. Press the power control button on the front of the server. This will put the server in standby mode.
3. Disconnect the server from the power source.

**Note:** After you turn off the server, wait at least 5 seconds before you turn on the server again.

## Standby mode

Standby mode puts the server into a wait state. When in a wait state, the server is not running the operating system, and all core logic is shut down.

Complete the following steps to put the server into the standby mode:

1. Refer to your operating system documentation for the proper procedure to shutdown the operating system.
2. Press the power control button on the front of the server.





---

## Chapter 2. Arranging your workspace

To get the most from your server, arrange both the equipment you use and your work area to suit your needs and the kind of work you do. Your comfort is of foremost importance, but light sources, air circulation, and the location of electrical outlets also can affect the way you arrange your workspace.

---

### Comfort

Although no single working position is ideal for everyone, here are a few guidelines to help you find a position that suits you best.

Sitting in the same position for a long time can cause fatigue. A good chair can make a big difference. The backrest and seat should adjust independently and provide good support. The seat should have a curved front to relieve pressure on the thighs. Adjust the seat so that your thighs are parallel to the floor and your feet are either flat on the floor or on a footrest.

When using the keyboard, keep your forearms parallel to the floor and your wrists in a neutral, comfortable position. Try to keep a light touch on the keyboard and your hands and fingers relaxed. You can change the angle of the keyboard for maximum comfort by adjusting the position of the keyboard feet.

Adjust the monitor so the top of the screen is at, or slightly below, eye level. Place the monitor at a comfortable viewing distance, usually 51 to 61 cm (20 to 24 in.), and position it so you can view it without having to twist your body. Also position other equipment you use regularly, such as the telephone or a mouse, within easy reach.

---

### Glare and lighting

Position the monitor to minimize glare and reflections from overhead lights, windows, and other light sources. Even reflected light from shiny surfaces can cause annoying reflections on your monitor screen. Place the monitor at right angles to windows and other light sources, when possible. Reduce overhead lighting, if necessary, by turning off lights or using lower wattage bulbs. If you install the monitor near a window, use curtains or blinds to block the sunlight. You might have to adjust the Brightness and Contrast controls on the monitor as the room lighting changes throughout the day.

Where it is impossible to avoid reflections or to adjust the lighting, an antiglare filter placed over the screen might be helpful. However, these filters might affect the clarity of the image on the screen; try them only after you have tried all other methods of reducing glare.

Dust buildup compounds problems that are associated with glare. Remember to clean your monitor screen periodically using a soft cloth that is moistened with a nonabrasive liquid glass cleaner.

---

## Air circulation

Your server and monitor produce heat. Your server has one or more fans that pull in fresh air and force out hot air. The monitor lets hot air escape through vents. Blocking the air vents can cause overheating, which might result in a malfunction or damage. Place the server and monitor so that nothing blocks the air vents; usually, 15 cm (6 inches) of air space is sufficient. Also, make sure that the vented air is not blowing on someone else.

---

## Electrical outlets and cable lengths

The location of electrical outlets and the length of power cords and cables that connect to the monitor, printer, and other devices might determine the final placement of your server.

When arranging your workspace:

- Avoid the use of extension cords. When possible, plug the server power cords directly into electrical outlets.
- Keep power cords and cables neatly routed away from walkways and other areas where they might get kicked accidentally.

For more information about power cords, refer to the power cord information in this on-line publication.

---

## Chapter 3. Configuring your server

The following configuration programs are provided with your server:

- **Configuration/Setup Utility**

This program is part of the basic input/output system (BIOS) code that comes with your server. You can use this program to configure the serial connector assignment, change the drive startup sequence, set the date and time, and set passwords. See “Using the Configuration/Setup Utility program” for more information.

- **SCSISelect Utility**

With the SCSISelect Utility program, you can configure the devices that are attached to the SCSI adapter (provided in some models). Use this program to change default values, resolve configuration conflicts, and perform a low-level format on a SCSI hard disk drive. See “Using the SCSISelect utility program (some models)” on page 16 for more information.

- **PXE Boot Agent Utility**

The Preboot eXecution Environment (PXE) Boot Agent Utility program is part of the BIOS code that comes with your server. You can use this program to change network startup (boot) protocols and startup order, to select operating-system wake-up support, and to set menu wait times.

- **ServerGuide CDs**

The *ServerGuide* CDs include software setup and installation tools that are specifically designed for IBM xSeries 300 servers. You can use these CDs during the initial installation of your server to configure the server hardware and to simplify your NOS installation. The *ServerGuide* CDs also contain a collection of application programs, which you can install after your server is up and running. See Chapter 4, “Using the ServerGuide CDs,” on page 21 for more detailed information.

---

### Using the Configuration/Setup Utility program

Configuration/Setup is a menu-driven utility that is part of the BIOS code that comes with your server. You can use it to:

- Configure serial connector assignments
- Change the drive startup sequence
- Enable USB keyboard and mouse support
- Resolve configuration conflicts
- Set the date and time
- Set passwords

The following sections provide instructions for starting the Configuration/Setup Utility program and descriptions of the menu choices that are available.

### Starting the Configuration/Setup Utility program

Complete the following steps to start the Configuration/Setup Utility program:

1. Turn on the server and watch the monitor screen.
2. When the message Press F1 for Configuration/Setup appears, press F1.
3. Follow the instructions that appear on the screen.

## Choices available from the Configuration/Setup main menu

From the Configuration/Setup Utility main menu, you can select settings that you want to change. The Configuration/Setup Utility main menu is similar to the following illustration:

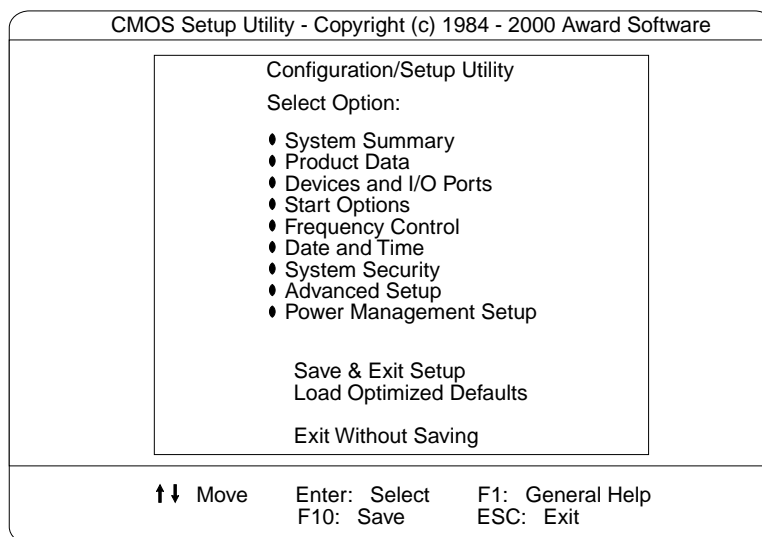

### Notes:

1. You can press F1 to display help information for a selected menu item.
2. The choices on some menus might differ slightly from the ones that are described in this book, depending on the version of BIOS code in your server.

Descriptions of the choices that are available from the main menu are as follows:

- **System Summary**

Select this choice to display configuration information. This includes the type and speed of the microprocessor and the amount of memory that is installed.

Changes that you make to configuration settings appear on this summary screen. You cannot edit the fields.

This choice appears on both the full and limited Configuration/Setup Utility menus.

- **Product Data**

Select this choice to view system information, such as the machine type and model, the server serial number, and the revision level or issue date of the BIOS code that is stored in the flash electrically erasable programmable read-only memory (EEPROM).

- **Devices and I/O Ports**

Select this choice to view or change the assignments for devices and input/output ports. This choice appears only on the full Configuration/Setup Utility main menu.

- **Start Options**

Select this choice to view or change the start options. Start options take effect when you start your server.

You can select keyboard operating characteristics, such as the keyboard speed. You also can specify whether the server starts with the keyboard number lock on or off.

The server uses a startup sequence to determine the device from which the operating system starts. For example, you can define a startup sequence that checks for a startable diskette in the diskette drive, then checks the hard disk drive in bay 5, and then checks a network adapter.

You can enable a virus-warning test that checks for changes in the master boot record at startup. You also can choose to run POST in the quick mode, and read the microprocessor serial number.

- **Frequency Control**

Select this choice to enable or disable the auto-detect DIMM/PCI clock.

- **Date and Time**

Select this choice to set the system date and time.

The system time is in a 24-hour format: hour:minute:second.

**Note:** You may also set the date and time using the procedures provided on the *ServerGuide* CDs.

- **System Security**

Select this choice to set a power-on or an administrator password. See “Using passwords” on page 16 for more information.

- **Advanced Setup**

Select this choice to change values for advanced hardware features, such as Cache Control and PCI configuration.

A message appears above the choices on this menu to alert you that the system might malfunction if these options are configured incorrectly. Follow the instructions on the screen carefully.

- **Cache Control**

Select this choice to enable or disable the microprocessor cache.

**Attention:** Do not make changes to the Cache Control unless directed to do so by an IBM authorized service representative.

- **ROM Shadowing**

Select this choice to enable or disable the state of ROM shadowing.

- **Chipset Feature**

Select this choice to modify settings that control features of the core chip set on the system board.

**Attention:** Do not make changes to the Chipset Feature unless directed to do so by IBM.

- **Memory Settings**

Select this choice to manually enable or disable a bank of memory.

If a memory error is detected during POST or memory configuration, the server can automatically disable the failing memory bank and continue operating with reduced memory capacity. If this occurs, you must manually enable the memory bank after the problem is corrected. Select **Memory Settings** from the Advanced Setup menu, use the arrow keys to highlight the bank that you want to enable; then, use the arrow keys to select **Enable**.

- **Power Management Setup**

Select this choice to enable or disable system power savings.

- **Save & Exit Setup**

Select this choice to save your customized settings.

- **Load Optimized Defaults**

Select this choice to discard your changes and restore the factory settings.

- **Exit Without Saving**

Select this choice if you want to exit without saving changes, or if no changes have been made.

## Using passwords

The **System Security** choice appears only on the full Configuration/Setup Utility menu. After you select this choice, you can set a power-on password or an administrator password.

You can use any combination of up to seven characters (A–Z, a–z, and 0–9) for the power-on password or the administrator password. When you have set one or both of the passwords, record them and keep them in a secure place.

If both a power-on and administrator password are set, you can type either password at the password prompt that appears as you start your server. However, if you want to change the settings in the Configuration/Setup Utility program, you must type the administrator password to access the full configuration menus. If you type the power-on password, you can only view limited information in the Configuration/Setup Utility program.

If you forget the power-on password, you can regain access to the server through either of the following methods:

- Start the Configuration/Setup Utility program and change the power-on password.
- Change the jumper position on the CMOS jumper as described in “Clearing CMOS” on page 79.

---

## Using the SCSISelect utility program (some models)

SCSISelect is a built-in, menu-driven configuration utility program that you can use to:

- View the default SCSI IDs
- Locate and correct configuration conflicts

The following sections provide instructions for starting the SCSISelect Utility program and descriptions of the menu choices that are available.

**Note:** If your server has a redundant arrays of independent disks (RAID) adapter installed, use the configuration method that is supplied with the RAID adapter to view or change SCSI settings for devices attached to the adapter.

## Starting the SCSISelect utility program

Complete the following steps to start the SCSISelect Utility program:

1. Turn on the server.
2. When the <<< Press <CTRL><A> for SCSISelect™ Utility! >>> prompt appears, press Ctrl+A.
3. When the Would you like to configure the host adapter or run the SCSI disk utility? question appears, make your selection and press Enter.
4. Use the arrow keys to select a choice from the menu.
  - Press Esc to exit the SCSISelect Utility program.
  - Press the F5 key to switch between color and monochrome modes (if your monitor permits).

5. Follow the instructions on the screen to change the settings of the selected items; then, press Enter.

## Choices available from the SCSISelect menu

The following choices appear on the SCSISelect Utility menu:

- **Configure/View Host Adapter Settings**

Select this choice to view or change the SCSI controller settings. To reset the SCSI controller to its default values, press F6; then, follow the on-screen instructions.

You can view or change the following controller settings:

- **Host Adapter SCSI ID**

Select this choice to view the SCSI controller identification (ID), which is usually 7.

- **SCSI Parity Checking**

Select this choice to view the assigned value of *Enabled*.

- **Host Adapter SCSI Termination**

Select this choice to view the assigned value of *Automatic*.

- **Boot Device Options**

Select this choice to configure startable-device parameters. Before you can make updates, you must know the ID of the device whose parameters you want to configure.

- **SCSI Device Configuration**

Select this choice to configure SCSI-device parameters. Before you can make updates, you must know the ID of the device whose parameters you want to configure.

**Note:** The Maximum Sync Transfer Rate is the transfer rate for Ultra SCSI devices.

- The transfer rate for Ultra160 low voltage differential (LVD) devices is 160.0 MBps.
- The transfer rate for Ultra2 SCSI LVD devices is 80.0 MBps.
- The transfer rate for Fast SCSI devices is 20.0 MBps.

- **Advanced Configuration Options**

Select this choice to view or change the settings for advanced configuration options. These options include support for large hard disk drives and support for drives with Ultra SCSI speeds.

- **SCSI Disk Utilities**

Select this choice to view the SCSI IDs that are assigned to each device or to format a SCSI device.

To use the utility program, select a drive from the list. Read the on-screen instructions carefully before making a selection.

**Note:** If you press Ctrl+A before the selected drives are ready, an Unexpected SCSI Command Failure screen might appear. Restart the server and watch the SCSISelect messages as each drive starts. After the drive that you want to view or format starts, press Ctrl+A.

---

## Using the PXE boot agent utility program

The PXE boot agent is a built-in, menu-driven configuration utility program that you can use to:

- Change network startup (boot) protocols
- Change startup (boot) order
- Select whether or not to display setup prompt
- Set menu wait time
- Select OS wake up support

The following sections provide instructions for starting the PXE Boot Agent Utility program and descriptions of the menu choices that are available.

## Starting the PXE boot agent utility program

To start the PXE Boot Agent Utility program:

1. Turn on the server.
2. When the Initializing Intel (R) Boot Agent Version X.X.XX PXE 2.0 Build XXX (WfM 2.0) prompt appears, press Ctrl+S.  
**Note:** By default you will have two seconds after the prompt appears on the screen to press Ctrl+S.
3. Use the arrow keys or press Enter to select a choice from the menu.
  - Press Esc to return to the previous menu.
  - Press the F4 key to exit.
4. Follow the instructions on the screen to change the settings of the selected items; then, press Enter.

## Choices available from the PXE boot agent utility

The following choices appear on the PXE boot agent utility menu:

- **Network Boot Protocol**  
PXE is the default value for this menu item.  
**Note:** Do not change this value. There are no other network boot protocols supported.
- **Boot Order**  
Select this choice to change the order in which boot devices are queried.
  - Try local drives first, then network (Default)
  - Try network only
  - Try local drives only
  - Try network first, then local drives**Note:** This option is not supported on this product. To change the boot order use the Configuration/Setup utility. See “Using the Configuration/Setup Utility program” on page 13 for more information.
- **Show setup prompt**  
Select this choice to either display the PXE setup prompt or disable it. Disable is the default setting.  
When this choice is enabled, **Press Ctrl+S to enter the setup menu** will appear on the screen under the initializing prompt.



- **Setup time wait menu**

Select this choice to set the amount of time (in seconds) that the system will pause during initialization for a Ctrl+S input.

- 2 seconds (Default)
- 3 seconds
- 5 seconds
- 8 seconds

- **Legacy OS wake up support**

Select this choice to enable or disable the operating system wake up support.

- Disabled (Default)
- Enabled

**Notes:**

1. Use the default setting for Advanced Configuration and Power Interface (ACPI) aware operating systems, such as Windows 2000 and Windows NT.
2. If your server is running a non-ACPI operating system, you must set this selection to enable to use the Wake-on-LAN support.
3. When using a non-ACPI operating system, do not send a wake up packet to the server while it is turned on. If a wake up packet has been sent while the server is on, and you are unable to turn the server off, see the "Power" section in the Troubleshooting charts, on page 82 for more information.



---

## Chapter 4. Using the ServerGuide CDs

The ServerGuide CDs include easy-to-use software setup and installation tools that are specifically designed for your IBM server. The ServerGuide Setup and Installation program detects the server model and hardware options that are installed and uses that information during setup to configure the hardware. The ServerGuide tools simplify NOS installations by providing updated device drivers, and in some cases, installing them automatically.

If a newer version of the ServerGuide software is available, you can purchase an update package. For details, see the ServerGuide Updates form that comes with your server library, or go to the ServerGuide fulfillment Web site at <http://www.ibm.com/pc/coupon>

The ServerGuide software has these features to make setup easier:

- An easy-to-use interface with online help
- Diskette-free setup and configuration programs that are based on detected hardware
- *Performance Optimizer* program, which easily tunes your server for your environment
- A system BIOS update program, which updates the BIOS directly from the CD
- Device drivers that are provided for your server model and detected hardware
- NOS partition size and file-system type that are selectable during setup
- Powerful application programs and administration tools

## Features at a glance

The following is a summary of ServerGuide features.

**Note:** Exact features and functions can vary with different versions of the ServerGuide software. To learn more about the version that you have, start the *Setup and Installation CD* and view the Online Overview.

<b>Setup and Installation CD</b>	<b>Setup and Installation CD</b> (continued)	<b>System Updates and Applications CD</b> (continued)
<p><b>Note:</b> The ServerGuide program requires a supported IBM server with an <i>enabled</i> startable (bootable) CD-ROM drive. Not all features are supported on all models.</p> <ul style="list-style-type: none"> <li>• Sets system date and time.</li> <li>• Detects the ServeRAID adapter or controller and runs the ServeRAID configuration program.</li> <li>• Updates the licensed internal code (firmware) level without creating diskettes.</li> <li>• Checks the system BIOS and microcode (firmware) levels of supported options to determine whether a later level is available from the CD. You can perform updates without the use of diskettes.</li> <li>• Provides the Performance Optimizer program to easily tune your server for your environment.</li> <li>• Creates a System Partition on the default drive. You can run server-specific utility programs after setup.</li> <li>• Detects installed hardware options and provides updated device drivers for most adapters and devices.</li> </ul>	<ul style="list-style-type: none"> <li>• Creates a <i>Setup Replication Diskette</i> for replicating setup selections for other servers of the same model.</li> <li>• Provides diskette-free installation for Microsoft® Windows® 2000, Windows NT®, and NetWare operating systems.</li> <li>• Provides a replicated installation path for multiple Windows 2000, Windows NT Server 4.0, and Windows Enterprise Edition, and Red Hat Linux®.</li> <li>• Includes an online README file with links to tips for your hardware and NOS installation.</li> </ul> <p><b>Note:</b> Installation requires your NOS CD.</p> <p><b>System Updates and Applications CD</b></p> <ul style="list-style-type: none"> <li>• Creates diagnostic, RAID, device driver, and other support diskettes from the CD; or with an Internet connection, you can check for an update from a dedicated IBM file transfer protocol (FTP) server.</li> <li>• Installs some updates without requiring diskettes. Where applicable, you can run executable files directly from the CD or unzip files to any drive on your server or another server on your network.</li> </ul>	<ul style="list-style-type: none"> <li>• Includes a vast library of fully tested device drivers for your server.</li> <li>• Includes a search function to help you locate updates by title or keywords.</li> <li>• Installs powerful applications directly from the CD. See the CD label for a current list of applications.</li> </ul>

---

## Setup and configuration overview

When you use the *Setup and Installation* CD, you do not need setup diskettes. You can use the CD to configure any supported IBM server model. The setup program checks your system BIOS, service processors, and other system hardware to determine if system updates are available. The setup program provides a list of tasks that are required to set up your server model. On RAID servers, you can run the ServeRAID Manager program to create logical drives.

**Note:** Exact features and functions can vary with different versions of the ServerGuide software.

When you start the *Setup and Installation* CD, the following happens:

- You are prompted for your language, country, and keyboard layout. (This information is stored and later passed on to the NOS installation program.)
- ServerGuide displays choices for running the configuration programs. For example:
  - The Express Configuration method runs the required programs for your server, based on the hardware that is detected.
  - The Custom Configuration method displays all programs that are available for your server, and you decide which programs to run.
  - The Replicated Configuration method provides the option of duplicating your setup selections to other servers that are the same model.
- If you select the Custom Configuration method, the following programs are optional. If you select the Express Configuration method, some or all of these programs are run, depending on the hardware that is detected.
  - The Set Date and Time feature is provided so that you do not have to use the Configuration/Setup Utility program to access these settings.
  - The Clear Hard Disks program is provided so you can delete all partitions on all hard disk drives. If the server has a ServeRAID adapter installed, you can select to restore the configuration on the ServeRAID adapter to the factory default settings.
  - ServerGuide checks the server BIOS and microcode (firmware) levels for supported options and then checks the CD for a newer level. CD content can be newer than the hardware. ServerGuide can perform a flash update of the BIOS and supported microcode (firmware) options without the use of diskettes.
  - The ServeRAID configuration program starts, leading you through the entire configuration process.
  - The Performance Optimizer program easily tunes your server for your environment.
  - ServerGuide creates a System Partition on the default drive.
- ServerGuide displays a confirmation summary, so that you will know when you have completed all the required tasks. Then, you are ready to install your NOS.

**Notes:**

1. Plug and Play adapters are configured automatically. Non-Plug and Play adapters or non-IBM adapters might require switch settings, additional device drivers, and installation after the NOS is installed. See the documentation that comes with the adapter.
2. Diagnostics for your server come in BIOS or on a separate diagnostics CD.

---

## System Partition

ServerGuide creates a 50 MB System Partition on the default drive. The System Partition contains server-specific utility programs such as service processor disk operating system (DOS) utilities, system diagnostics, flash BIOS updates, and other programs.

**Note:** Programs in the System Partition vary by server model, and not all server models run utility programs from the System Partition. To determine which ones do, start the *Setup and Installation* CD and view the online Overview.

After setup is complete, you can access programs in the System Partition by restarting the server and pressing Alt+F1 when the prompt is displayed. The System Partition menu displays the programs that are available on your server model.

---

## Typical NOS installation

You can use ServerGuide to shorten your installation time. ServerGuide provides the necessary device drivers, based on the hardware that you have and the NOS that you are installing. The following is a brief explanation of a typical ServerGuide NOS installation.

**Note:** Exact features and functions can vary with different versions of the ServerGuide software

- After you have completed the setup process, the operating system installation program starts. (You will need your copy of the NOS CD to complete the installation.)
- ServerGuide stores information about the server model, service processor, hard disk controllers, and network adapters. It then checks the CD for newer device drivers. This information is stored and then passed to the NOS installation program.
- With some NOS installations, you can create a *NOS Replication Diskette* for setting up additional servers. The diskette will contain the Internet protocol (IP) address, server name, and other selections.
- ServerGuide presents NOS partition options that are based on your NOS selection and the installed hard disk drives.
- If you are installing the NOS from diskette, ServerGuide displays the required diskettes that you must create, and the optional diskettes that you might want to create. The diskettes that you can create are the device driver diskettes for the installed adapters or controllers.

ServerGuide prompts you to insert your NOS CD and restart the server. At this point, the installation program for the NOS (for example, Microsoft Windows 2000) takes control to complete the installation.

---

## Setting up or updating multiple servers

You can use ServerGuide to create diskettes that help you set up or update multiple servers. You can modify information on the diskettes as you use them to set up or update other servers.

**Note:** Availability and function can vary by server model and by the hardware that is installed.

You can create a *Setup Replication Diskette*, which contains your hardware configuration selections. Use this diskette to replicate selections to other servers that are of the same model.

You can create a *NOS Replication Diskette*, which contains your server name, domain name, and other information that you need to complete multiple installations. This feature supports systems running Windows 2000, Windows NT Server 4.0, and Red Hat Linux.

---

## Installing your NOS without ServerGuide

If you have already configured the server hardware and you decide not to use ServerGuide to install your NOS, download the latest NOS installation instructions:

1. Go to <http://www.ibm.com/pc/support>
2. Click **Servers**.
3. From the **Family** field, select your server model.
4. Click **OS installation**. The available installation instructions are listed.

---

## Additional programs included with ServerGuide

As a convenience, ServerGuide comes with additional software to assist you with the server installation.

A variety of powerful applications are included with ServerGuide. Offerings can vary with the different versions of the ServerGuide software. Check the application CD labels for a list of applications, or start the *Setup and Installation* CD and view the online Overview.

---

## Error symptoms

This section provides ServerGuide error symptoms and probable solutions.

<b>Setup and Installation CD</b>	<b>Action</b>
<i>Setup and Installation</i> CD will not start.	<ul style="list-style-type: none"><li>• Ensure that the system is a supported server model with a startable (bootable) CD-ROM drive.</li><li>• If the startup (boot) sequence settings have been altered, be sure that the CD-ROM is first in the startup sequence.</li><li>• If more than one CD-ROM drive is installed, be sure that only one drive is set as the primary drive. Start the CD from the primary drive.</li></ul>
ServeRAID program cannot view all installed drives or cannot install NOS.	<ul style="list-style-type: none"><li>• Ensure that there are no duplicate SCSI IDs or IRQ assignments.</li><li>• Ensure that the hard disk drive is connected properly.</li></ul>
The operating system installation program continuously loops.	Free up more space on the hard disk.

<b>Setup and Installation CD</b>	<b>Action</b>
ServerGuide will not start your NOS CD.	Ensure that the NOS CD is supported by ServerGuide. See the <i>Setup and Installation</i> CD label for a list of supported NOS versions.
Cannot install NOS.	Ensure that the NOS is supported on your server. If the NOS is supported, either there is no logical drive defined (ServerRAID systems) or the ServerGuide System Partition is not present. Run the ServerGuide setup and configuration program and ensure that the setup is complete.

<b>System Updates and Applications CD</b>	<b>Action</b>
Get "time out" or "Unknown host" errors.	Ensure that you have access to the Internet through FTP directly.



## Chapter 5. Installing options

This chapter provides instructions to help you install options in your server. Some option-removal instructions are provided, in case you need to remove one option to install another. For a list of supported options for your server, see the ServerProven™ list at <http://www.ibm.com/pc/compat>.

### Major components of the xSeries 300

The following illustration shows the locations of major components in your server.

**Note:** The illustrations in this document might differ slightly from your hardware.

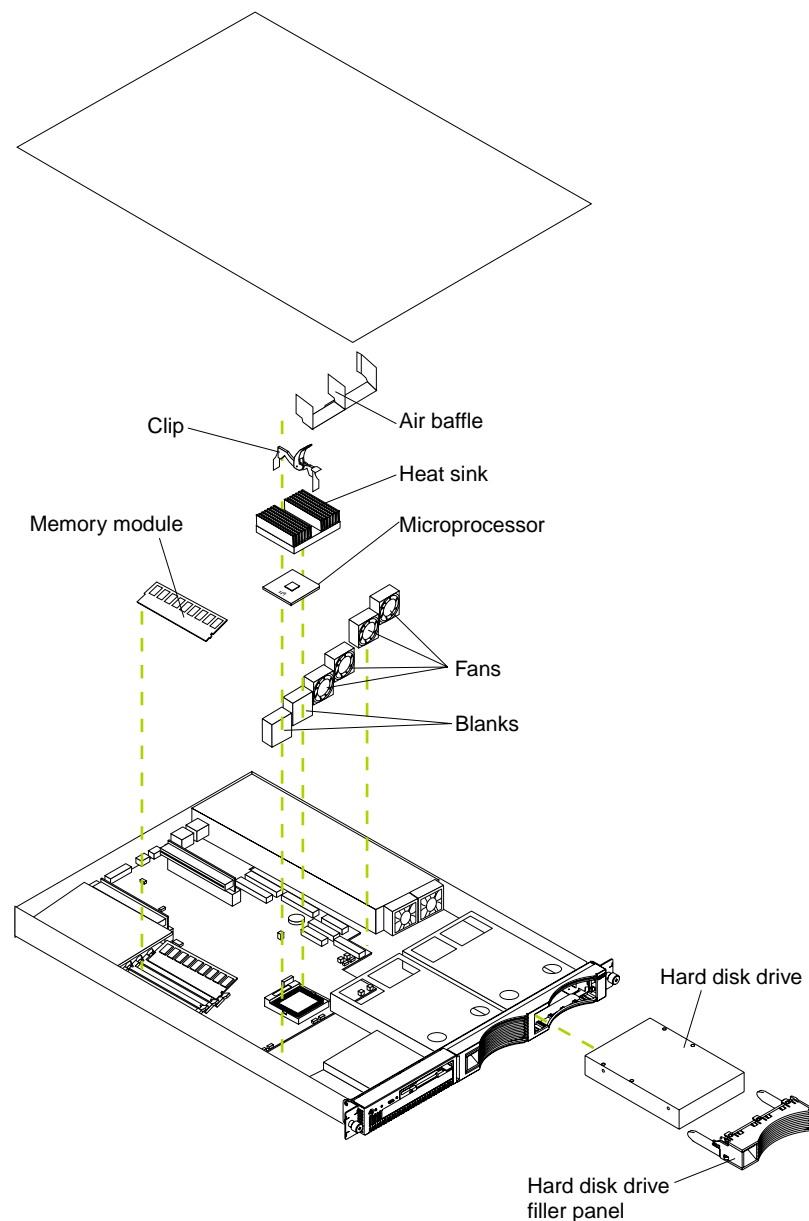

# System board internal cable connectors

The following illustration identifies the internal connectors on the system board.

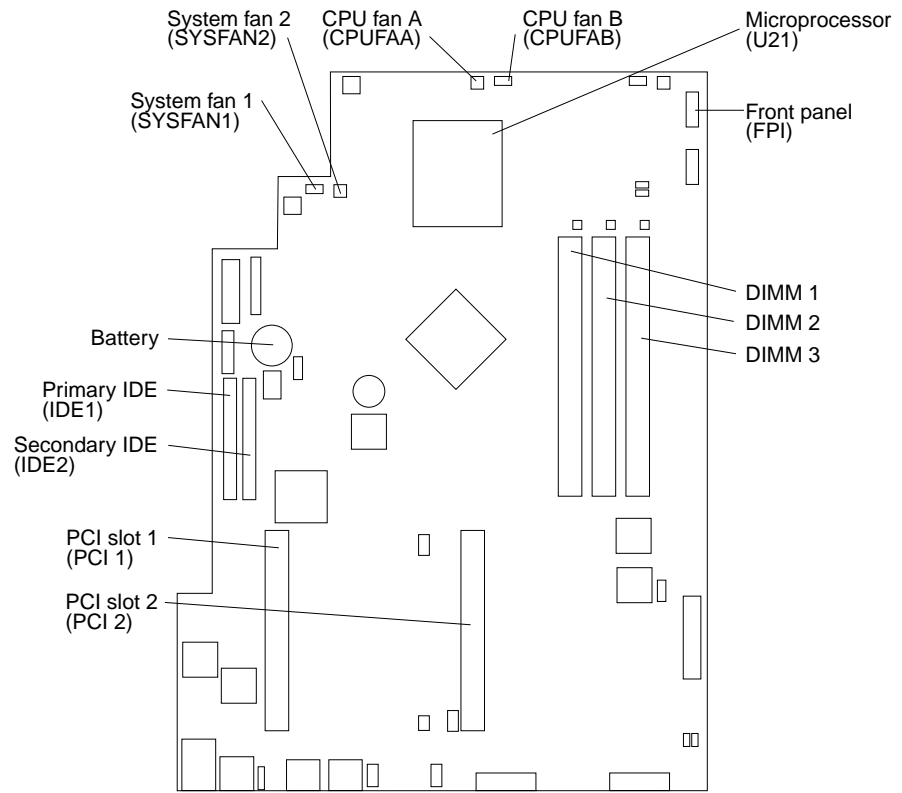

## System board jumpers

The following illustration identifies the jumpers on the system board.

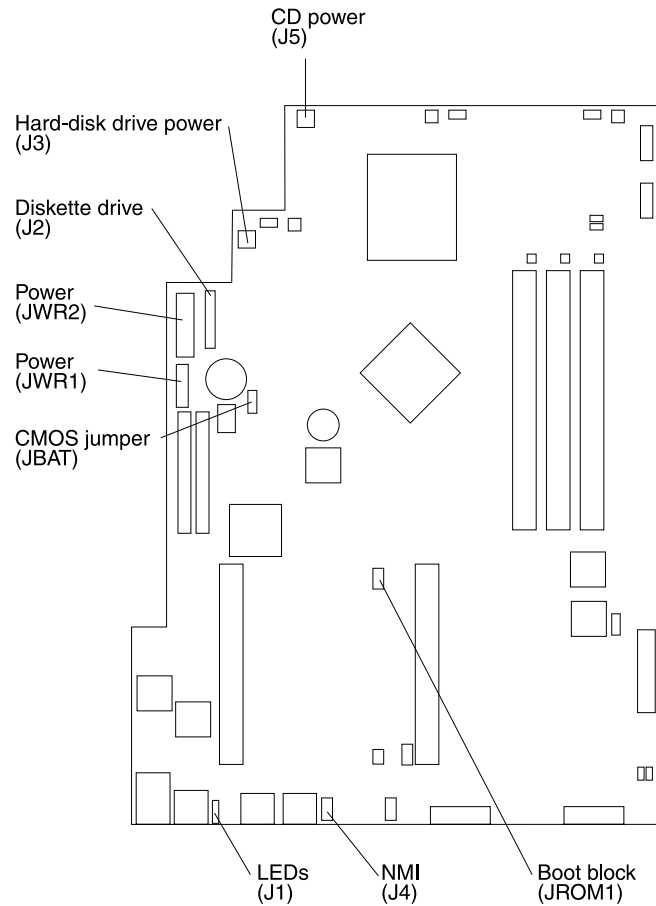

## Before you begin

Before you begin to install options in your server, read the following information:

- Become familiar with the information in “Handling static-sensitive devices” on page 30 and the safety guidelines provided in the “Safety Information” on page 31. These guidelines will help you work safely while working with your server or options.
- Make sure that you have an adequate number of properly grounded electrical outlets for your server, monitor, and any other options that you intend to install.
- Back up all-important data before you make changes to disk drives.
- For a list of supported options for the xSeries 300, refer to <http://www.ibm.com/pc/us/compat> on the World Wide Web.

## System reliability considerations

To help ensure proper cooling and system reliability, make sure that:

- Each of the drive bays has an electromagnetic compatibility (EMC) shield and either a drive or a filler panel installed.
- There is space around the server to allow the cooling system to work properly.
- Cables for optional adapters are routed according to the instructions that are provided with the adapters.
- A failed fan is replaced within 48 hour.

## Handling static-sensitive devices

**Attention:** Static electricity can damage electronic devices and your system. To avoid damage, keep static-sensitive devices in their static-protective package until you are ready to install them.

To reduce the possibility of electrostatic discharge, observe the following precautions:

- Limit your movement. Movement can cause static electricity to build up around you.
- Handle the device carefully, holding it by its edges or its frame.
- Do not touch solder joints, pins, or exposed printed circuitry.
- Do not leave the device where others can handle and possibly damage the device.
- While the device is still in its anti-static package, touch it to an unpainted metal part of the system unit for at least two seconds. (This drains static electricity from the package and from your body.)
- Remove the device from its package and install it directly into your system unit without setting it down. If it is necessary to set the device down, place it in its static-protective package. Do not place the device on your system unit cover or on a metal table.
- Take additional care when handling devices during cold weather because heating reduces indoor humidity and increases static electricity.

## Safety Information

Before installing this product, read the Safety Information.

مع، يجب قراءة دات السلامة

Antes de instalar este produto, leia as Informações de Segurança.

在安装本产品之前，请仔细阅读 **Safety Information** (安全信息)。

安裝本產品之前，請先閱讀「安全資訊」。

Prije instalacije ovog produkta obavezno pročitajte Sigurnosne Upute.

Před instalací tohoto produktu si přečtěte příručku bezpečnostních instrukcí.

Læs sikkerhedsforskrifterne, før du installerer dette produkt.

Lees voordat u dit product installeert eerst de veiligheidsvoorschriften.

Ennen kuin asennat tämän tuotteen, lue turvaohjeet kohdasta Safety Information.

Avant d'installer ce produit, lisez les consignes de sécurité.

Vor der Installation dieses Produkts die Sicherheitshinweise lesen.

Πριν εγκαταστήσετε το προϊόν αυτό, διαβάστε τις πληροφορίες ασφάλειας (safety information).

לפני שתתקינו מוצר זה, קראו את הוראות הבטיחות.

A termék telepítése előtt olvassa el a Biztonsági előírásokat!

Prima di installare questo prodotto, leggere le Informazioni sulla Sicurezza

製品の設置の前に、安全情報をお読みください。

본 제품을 설치하기 전에 안전 정보를 읽으십시오.

Пред да се инсталира овој продукт, прочитајте информацијата за безбедност.

Les sikkerhetsinformasjonen (Safety Information) før du installerer dette produktet.

Przed zainstalowaniem tego produktu, należy zapoznać się z książką "Informacje dotyczące bezpieczeństwa" (Safety Information).

Antes de instalar este produto, leia as Informações sobre Segurança.

Перед установкой продукта прочтите инструкции по технике безопасности.

Pred inštaláciou tohto zariadenia si pečítajte Bezpečnostné predpisy.

Pred namestitvijo tega proizvoda preberite Varnostne informacije.

Antes de instalar este producto lea la información de seguridad.

Läs säkerhetsinformationen innan du installerar den här produkten.

Statement 1



**Danger**

Electrical current from power, telephone, and communication cables is hazardous.

To avoid a shock hazard:

- Do not connect or disconnect any cables or perform installation, maintenance, or reconfiguration of this product during an electrical storm.
- Connect all power cords to a properly wired and grounded electrical outlet.
- Connect to properly wired outlets any equipment that will be attached to this product.
- When possible, use one hand only to connect or disconnect signal cables.
- Never turn on any equipment when there is evidence of fire, water, or structural damage.
- Disconnect the attached power cords, telecommunications systems, networks, and modems before you open the device covers, unless instructed otherwise in the installation and configuration procedures.
- Connect and disconnect cables as described in the following table when installing, moving, or opening covers on this product or attached devices.

<p>To connect:</p> <ol style="list-style-type: none"><li>1. Turn everything OFF.</li><li>2. First, attach all cables to devices.</li><li>3. Attach signal cables to connectors.</li><li>4. Attach power cords to outlet.</li><li>5. Turn device ON.</li></ol>	<p>To disconnect:</p> <ol style="list-style-type: none"><li>1. Turn everything OFF.</li><li>2. First, remove power cords from outlet.</li><li>3. Remove signal cables from connectors.</li><li>4. Remove all cables from devices.</li></ol>
---	---

## Statement 2

### CAUTION:



When replacing the lithium battery, use only IBM Part Number 33F8354 or an equivalent type battery recommended by the manufacturer. If your system has a module containing a lithium battery, replace it only with the same module type made by the same manufacturer. The battery contains lithium and can explode if not properly used, handled, or disposed of.

#### Do not:

- Throw or immerse into water.
- Heat to more than 100 C (212 F)
- Repair or disassemble

Dispose of the battery as required by local ordinances or regulations.

## Statement 3



### CAUTION:

When laser products (such as CD-ROMs, DVD drives, fiber optic devices, or transmitters) are installed, note the following:

- Do not remove the covers. Removing the covers of the laser product could result in exposure to hazardous laser radiation. There are no serviceable parts inside the device.
- Use of controls or adjustments or performance of procedures other than those specified herein might result in hazardous radiation exposure.



### Danger

Some laser products contain an embedded Class 3A or Class 3B laser diode. Note the following. Laser radiation when open. Do not stare into the beam, do not view directly with optical instruments, and avoid direct exposure to the beam.



Statement 4

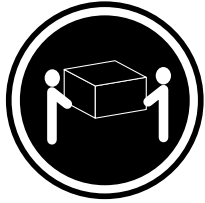

≥18 kg (39.7 lbs)

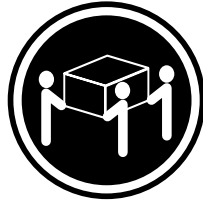

≥32 kg (70.5 lbs)

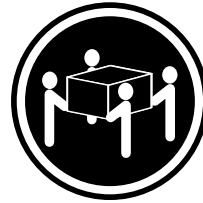

≥55 kg (121.2 lbs)

**CAUTION:**  
Use safe practices when lifting.

Statement 5



**CAUTION:**  
The power control button on the device and the power switch on the power supply do not turn off the electrical current supplied to the device. The device also might have more than one power cord. To remove all electrical current from the device, ensure that all power cords are disconnected from the power source.

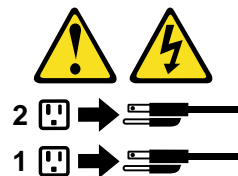

**Statement 8**



**CAUTION:**

**Never remove the cover on a power supply or any part that has the following label attached.**



**Hazardous voltage, current, and energy levels are present inside any component that has this label attached. There are no serviceable parts inside these components. If you suspect a problem with one of these parts, contact a service technician.**

---

## Removing the cover

Complete the following steps to remove the server cover:

1. Review the information in “Before you begin” on page 29.
2. Turn off the server and all attached devices and disconnect all external cables and power cords.
3. Remove the server from the rack.

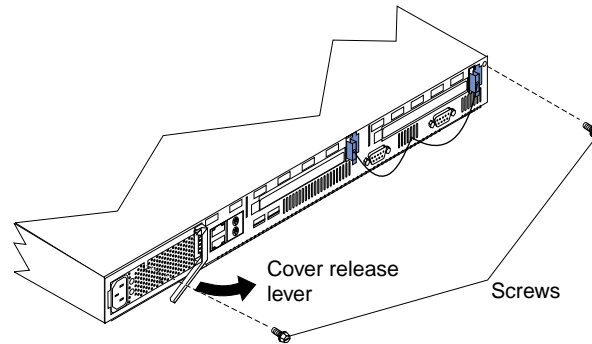

4. Remove the two screws from the rear of the server.
5. Pull out the cover-release lever at the back of the server to release the cover.
6. Slide the cover back, then up and off the server.

**Attention:** For proper cooling and airflow, replace the cover before turning on the server. Operating the server for extended periods of time (over 30 minutes) with the cover removed might damage server components.

---

## Working with adapters

This section provides information about the expansion slots on the system board, and peripheral component interconnect (PCI) adapters. Some models come with an Adaptec SCSI adapter installed in one of the PCI slots.

**Attention:** Your server comes with an integrated video controller on the system board. When you install a video adapter in a PCI slot, the server BIOS automatically disables the integrated video controller. This enables the video adapter in the PCI slot to control the video functions for your monitor.

The following illustration shows the location of the 33 MHz PCI expansion slots on the system board.

**Note:** The illustrations in this document might differ slightly from your hardware.

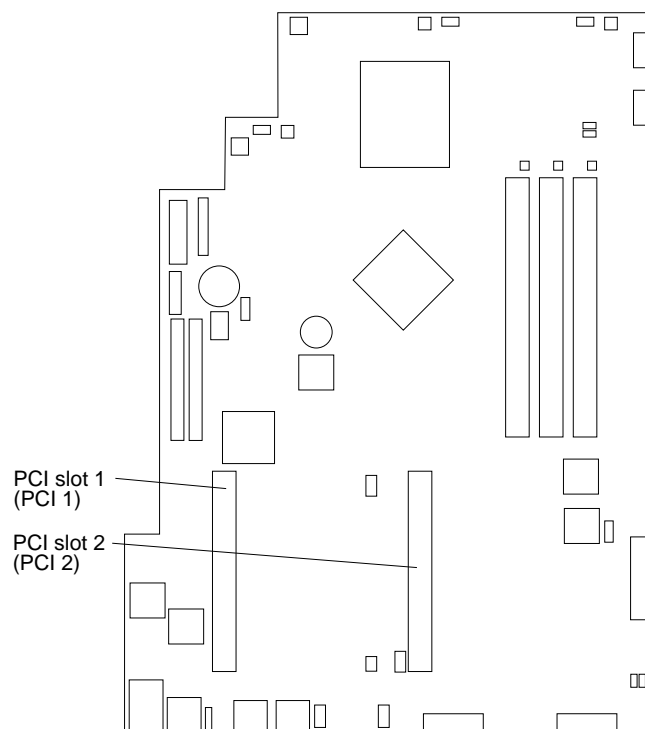

## Adapter considerations

Before you install adapters, review the following:

- Locate the documentation that comes with the adapter and follow those instructions in addition to the instructions in this chapter.
- If you need to change the switch settings or jumper settings on your adapter, follow the instructions that come with the adapter.
- You can install 32-bit full-length or half-length adapters in the expansion slots. Full-length adapters are installed in slot 1 only; half-length adapters are installed in either slot 1 or 2.
- Your server supports 5.0 V and universal PCI adapters; it does not support 3.3 V only adapters.
- Your server uses a rotational interrupt technique to configure PCI adapters. You can use this technique to install PCI adapters that currently do not support sharing of PCI interrupts.
- The system scans PCI slots to assign system resources. By default the system starts (boots) the CD-ROM and diskette drives first. Then it starts PCI slot 2, PCI slot 1, and the integrated Ethernet.

**Note:** You can use the Configuration/Setup Utility program to change the boot precedence for your server. Select **Start Options** from the Configuration/Setup Utility program main menu.

## Installing an adapter

Complete the following steps to install an adapter:

**Attention:** When you handle static-sensitive devices, take precautions to avoid damage from static electricity. For details on handling these devices, see “Handling static-sensitive devices” on page 30.

1. Review the information in “Before you begin” on page 29.
2. Turn off the server and peripheral devices.
3. Remove all external cables from the server; then, remove the server from the rack, and remove the cover.

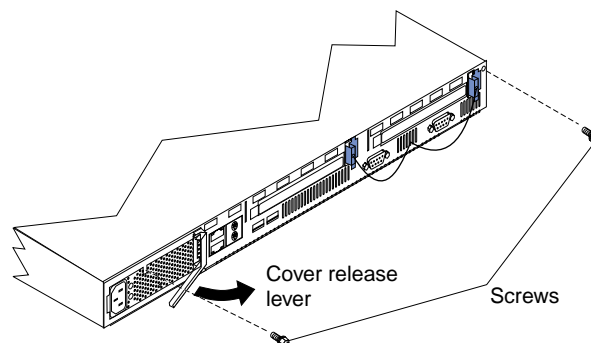

4. Remove the expansion-slot clip that holds the expansion-slot cover in place by sliding it upward and off the frame of the server.

**Note:** The illustrations in this document might differ slightly from your hardware.

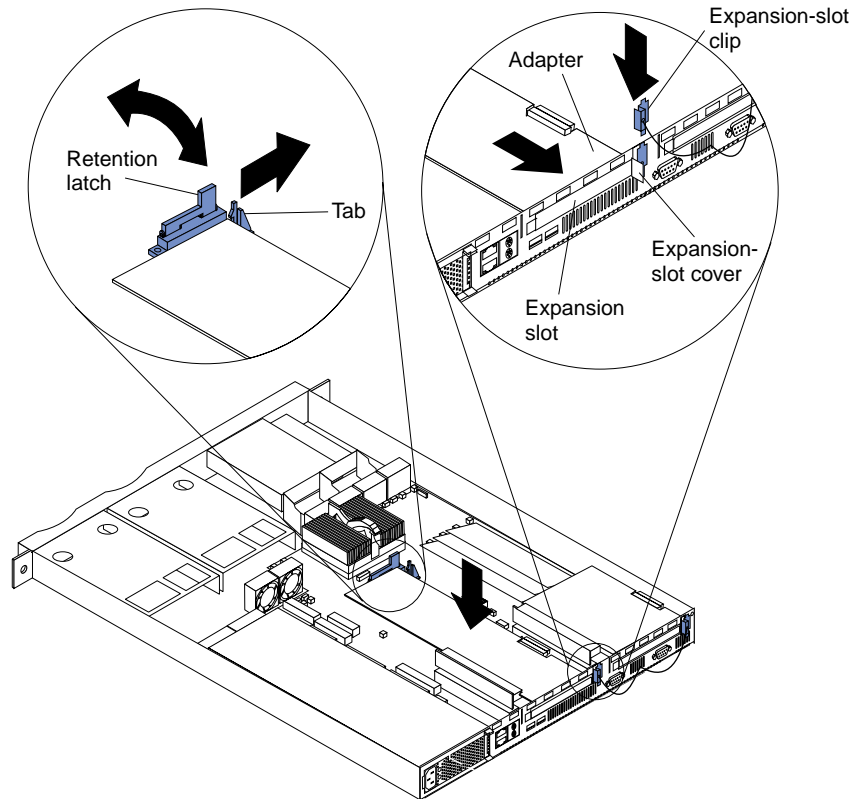

5. Remove the expansion-slot cover.
6. Refer to the documentation that comes with your adapter for any cabling instructions.

**Attention:** You should route adapter cables before you install the adapter.

7. Set any jumpers or switches as described by the adapter manufacturer.
8. Install the adapter:

**Note:** When installing an adapter into slot 2, skip steps a and d.

- a. Open the adapter-retention latch by pushing the blue tab to release it. Then, push the latch up to the full open position.
- b. Carefully grasp the adapter by its top edge or upper corners, and align it with the connector on the PCI riser card.
- c. Press the adapter *firmly* into the riser card connector.

**Attention:** When you install an adapter, be sure the adapter is correctly seated in the riser-card connector before you turn on the server. Improperly seated adapters might cause damage to the system board, the riser card, or the adapter.

- d. Push down on the blue adapter retention latch until it clicks into place, securing the adapter.
- e. Replace the expansion-slot clip by sliding it down until it latches into place and holds the adapter securely.

9. Connect the internal cables to the adapter.  
**Attention:** Route cables so that they do not block the flow of air from the fans.
10. If you have other options to install or remove, do so now.
11. Replace the cover on the server; then, reinstall the server in the rack and connect all external cables. For more information, see “Installing the cover” on page 46 for instructions.
12. Turn on the server.

---

## Hard disk drives

Your server supports two, 1-inch (26 mm) slim 3.5-inch hard disk drives. Depending on the model, your server supports two SCSI or two IDE hard disk drives.

### Installing or replacing a hard disk drive

Complete the following steps to install or replace a hard disk drive:

**Attention:** When you handle static-sensitive devices, take precautions to avoid damage from static electricity. For details on handling these devices, see “Handling static-sensitive devices” on page 30.

1. Inspect the drive for any signs of damage.
2. Review the information in “Before you begin” on page 29, and “Safety Information” on page 31.
3. Check the instructions that come with the drive for more information about installing your drive.

**Notes:**

- a. If you are installing an IDE hard disk drive, you must set the drive to primary (master) or secondary (subordinate), depending on the configuration of your server. See the documentation that comes with the drive for instructions.
  - b. If you are installing a SCSI hard disk drive, refer to the documentation that comes with your drive before installing it.
4. Turn off the server and peripheral devices and disconnect all external cables and power cords.
  5. Remove the server from the rack and remove the cover.

**Note:** If you are replacing a failing hard disk drive, remove the fans behind the drive bay in which you are working; then, disconnect the power and signal cables from the hard disk drive.
  6. Remove the filler panel or defective hard disk drive from one of the hard disk drive bays.
  7. Install the new hard disk drive in the drive bay:
    - a. Slide the drive into the bay and align the screw holes in the drive with the screw holes in the server chassis.
    - b. Use a screwdriver to secure the hard disk drive to the server chassis.

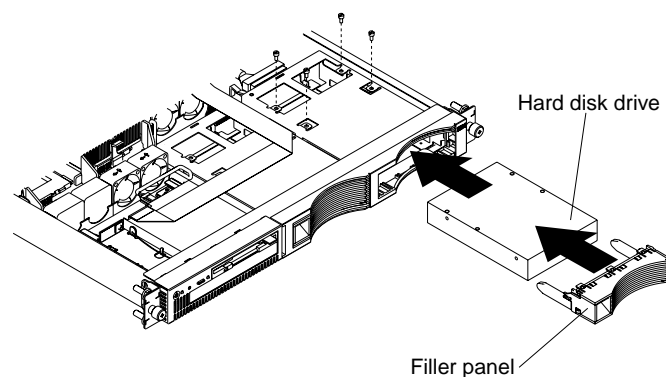

- c. Connect the signal cable and power cable to the rear of the drive. Ensure that the cables do not obstruct the fan behind the drive bay.



8. If you have other options to install or remove, do so now.
9. Replace the server cover. See “Installing the cover” on page 46.
10. Reconnect the external cables and power cords; then, turn on the server.

---

## Installing DIMMs

Adding memory to your server is an easy way to make programs run faster. You can increase the amount of memory in your server by installing options that are called DIMMs. Your server uses a noninterleaved memory configuration.

Memory considerations:

- Your server comes with a DIMM installed on the system board in DIMM connector 1. When installing additional memory modules, install the second memory module in DIMM connector 2 and the third in DIMM connector 3. (See the figure on page 42 for memory connector locations.)
- Your xSeries 300 server supports 128 MB, 256 MB, and 512 MB DIMMs. Your server supports a maximum of 1.5 GB of system memory. See the ServerProven® list at <http://www.ibm.com/pc/compat> for a list of memory modules for use with your server.
- The installing or removing of DIMMs changes the configuration information in the server. Therefore, you must change and save the new configuration information by using the Configuration/Setup Utility program. When you restart the server, the system displays a message indicating that the memory configuration has changed. Start the Configuration/Setup Utility program and select **Save Settings**. See Chapter 3, “Configuring your server,” on page 13 for more information.
- The illustrations in this document might differ slightly from your hardware.

Complete the following steps to install a DIMM:

**Attention:** When you handle static-sensitive devices, take precautions to avoid damage from static electricity. For details on handling these devices, see “Handling static-sensitive devices” on page 30.

1. Review the safety precautions in “Safety Information” on page 31.
2. Turn off the server and peripheral devices, and disconnect all external cables and power cords. Then, remove the cover (see “Removing the cover” on page 37 for details).
3. If necessary, remove the adapter in PCI slot 2 for easier access to the memory connectors.
4. Touch the static-protective package containing the DIMM to any unpainted metal surface on the server. Then, remove the DIMM from the package.

5. Install the DIMM:

- a. Open the retaining clip on each end of the DIMM connector. Turn the DIMM so that the pins align correctly with the connector.

**Attention:** To avoid breaking the retaining clips or damaging the DIMM connectors, open, and close the clips gently.

- b. Insert the DIMM into the connector by aligning the DIMM edges with the slots at each end of the DIMM connector. Firmly press the DIMM straight down into the connector by applying pressure on both ends of the DIMM simultaneously. Be sure that the retaining clips snap into the locked position when the DIMM is firmly seated in the connector.
- c. If a gap exists between the DIMM and the retaining clips, the DIMM has not been properly installed. In this case, open the retaining clips and remove the DIMM; then, reinsert the DIMM.

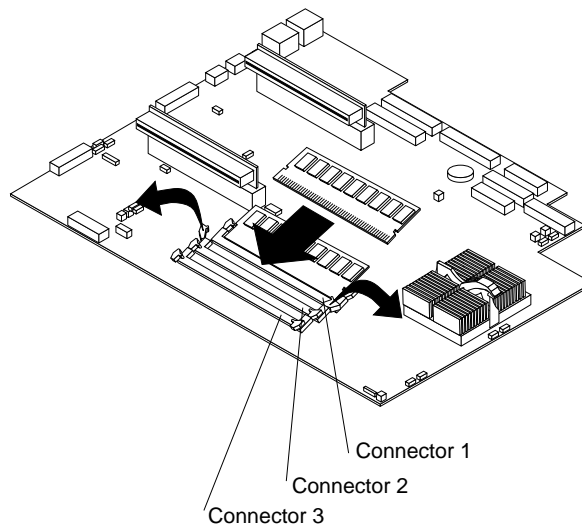

6. If you removed the PCI adapter as described in step 3, install it now.
7. If you have other options to install or remove, do so now.
8. Replace the cover. See “Installing the cover” on page 46.
9. Reconnect the external cables and power cords; then, turn on the peripheral devices and the server.

**Note:** If you want to remove a DIMM, reverse the previous steps.

---

## Replacing the fan assembly

Complete the following steps to replace the fan assembly:

1. Review the information in “Before you begin” on page 29.
2. Turn off the server and peripheral devices.
3. Remove all external cables from the server; then, remove the server from the rack and remove the cover. For more information, see “Removing the cover” on page 37 for instructions.
4. Remove the fan from the server:
  - a. Disconnect the fan cable from the system board.
  - b. Lift the fan away from the server.
5. Orientate the fan so that the air flow arrow on the side of the fan is facing or pointing toward the rear of the server.

**Note:** Proper air flow is from the front to the rear of the server.

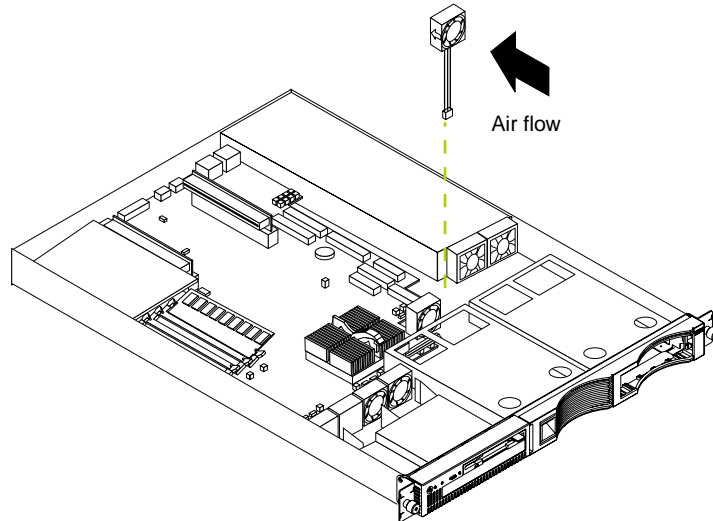

6. Push the replacement fan assembly into the server until it clicks into place.
7. Connect the fan cable to the system board.
8. If you have other options to install or remove, do so now.
9. Replace the cover. See “Installing the cover” on page 46.
10. Reconnect the external cables and power cords; then, turn on the peripheral devices and the server.

---

## Installing the cover

Complete the following steps to install the server cover:

1. Install the cover by placing it into position and sliding it forward. Make sure that the cover engages the tabs at the front and rear of the server.

**Attention:** Before sliding the cover forward, make sure that all of the tabs on the cover will engage the ledge at the front of the server properly. If all the tabs do not engage the ledge properly, it will be extremely difficult to remove the cover later.

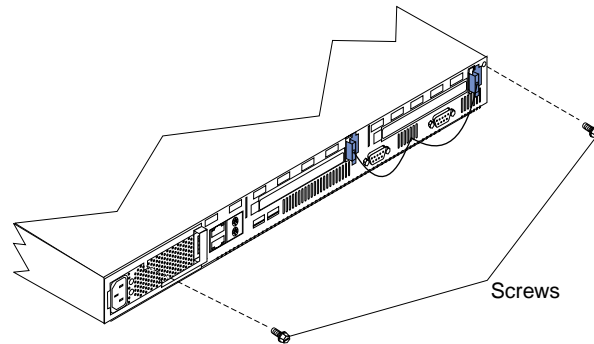

2. Install the screws to secure the cover as shown.
3. Reinstall the server in the rack. See the "Rack installation instructions" included with your server documentation for instructions.
4. Reconnect the power cord and all external cables to the server, and then plug the power cords into properly grounded electrical outlets. See "Rear view" on page 7 for connector locations.

---

## I/O connectors

Your server has the following I/O connectors:

- Serial connector
- Universal Serial Bus (USB) connectors
- Keyboard connector
- Video connector
- Auxiliary-device (pointing device) connector
- Ethernet connectors

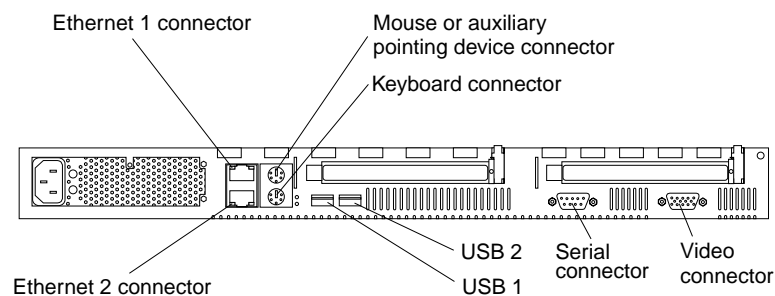

## Serial port

Your server has one standard serial port. Some application programs require specific ports, and some modems function properly only at certain serial port addresses. Use the Configuration/Setup Utility program to change the port address assignments and prevent conflicts.

Table 1. Serial port connector on the system board.

Connector	Port	Description
COM1	Serial port connector (external)	Default connection. Used by the operating system. The modem can be connected so that the system can dial out during problems.

### Viewing or changing the serial-port assignments

To view or change the serial-port assignments:

1. Restart the server and watch the monitor screen.
2. When the message Press F1 for Configuration/Setup appears, press F1.
3. From the main menu, select **Devices and I/O Ports**; then, press Enter.

**Note:** The Devices and I/O Ports choice appears only on the full configuration menu. If you set two levels of passwords, you must enter the administrator password to access the full configuration menu.

4. Select the serial port; then, use the arrow keys to advance through the settings available.
5. Select **Save Settings**; then, select **Exit Setup** to exit from the Configuration/Setup Utility main menu.

### Serial-port connector

Your server has one serial-port connector located on the rear of the server.

The following table and illustration shows the pin-number assignments for the 9-pin, male D-shell serial-port connector on the rear of your server. These pin-number assignments conform to the industry standard.

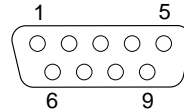

Table 2. Serial-port connector pin-number assignments.

Pin	Signal	Pin	Signal
1	Data carrier detect	6	Data set ready
2	Receive data	7	Request to send
3	Transmit data	8	Clear to send
4	Data terminal ready	9	Ring indicator
5	Signal ground		

## Universal Serial Bus ports

Your server has two Universal Serial Bus (USB) ports, which configure automatically. USB is an emerging serial interface standard for telephony and multimedia devices. It uses Plug and Play technology to determine the type of device attached to the connector.

### USB cables and hubs

You need a 4-pin cable to connect devices to USB 1 or USB 2. If you plan to attach more than two USB devices, you must use a hub to connect the devices. The hub provides multiple connectors for attaching additional external USB devices.

USB technology provides up to 12 megabits-per-second (Mbps) speed with a maximum of 127 external devices and a maximum signal distance of five meters (16 ft). per segment.

## USB-port connectors

Each USB port has an external connector on the rear of the server for attaching USB-compatible devices.

The following table and illustration show the pin-number assignments for the USB-port connectors on the rear of your server.

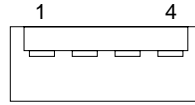

Table 3. USB-port connector pin-number assignments.

Pin	Signal
1	VCC
2	-Data
3	+Data
4	Ground

## Keyboard connector

There is one keyboard connector on the rear of the server.

**Note:** If you attach a standard keyboard to the keyboard connector, the USB ports, and devices will be disabled during the power-on self-test (POST).

The following table and illustration shows the pin-number assignments for the keyboard connector on the end of the cable.

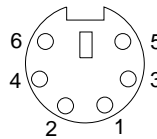

Table 4. Keyboard-connector (6-pin female) number assignments .

Pin	I/O	Signal
1	I/O	Data
2	N/A	Reserved
3	N/A	Ground
4	N/A	+5 V dc
5	I/O	Keyboard clock
6	N/A	Reserved

## Video connector

The following table shows the pin-number assignments for the 15-pin analog video connector on the rear of the server.

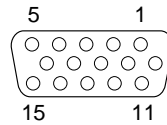

Table 5. Video-connector (15-pin female) number assignments.

Pin	Signal	Pin	Signal	Pin	Signal
1	Red	6	Ground	11	Not connected
2	Green or monochrome	7	Ground	12	DDC SDA
3	Blue	8	Ground	13	Horizontal synchronization (Hsync)
4	Not connected	9	+5 V dc DDC	14	Vertical synchronization (Vsync)
5	Ground	10	Ground	15	DDC SCL

## Auxiliary-device (pointing device) connector

There is one auxiliary-device connector that supports a mouse or other pointing device located on the rear of the server just under the keyboard connector.

The following table shows the pin-number assignments for the auxiliary-device connector on the end of the cable.

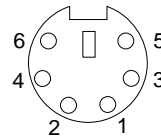

Table 6. Auxiliary or pointing-device-connector (6 pin female) number assignments .

Pin	Signal
1	Data
2	Not connected
3	Ground
4	+5 V dc
5	Clock
6	Not connected



## Ethernet ports

Your server comes with two integrated Ethernet controllers. These controllers provide an interface for connecting to 10-Mbps or 100-Mbps networks and provide full-duplex (FDX) capability, which enables simultaneous transmission and reception of data on the Ethernet local area network (LAN).

To access the Ethernet ports, connect a Category 3, 4 or 5 unshielded twisted-pair (UTP) cable to the RJ-45 connector on the rear of your server.

**Note:** The 100BASE-TX Fast Ethernet standard requires that the cabling in the network be Category 5 or higher.

### Configuring the Ethernet controllers

When you connect your server to the network, the Ethernet controllers automatically detect the data-transfer rate (10Mbps or 100Mbps) on the network and then set the controllers to operate at the appropriate rate. In addition, if the Ethernet ports that your server is connected to support auto-negotiation, the Ethernet controllers will set the appropriate duplex state. That is, the Ethernet controllers will adjust to the network data rate, whether the data rate is standard Ethernet (10BASE-T), Fast Ethernet (100BASE-TX), half duplex (HDX), or full duplex (FDX). The controllers support half-duplex (HDX) and full-duplex (FDX) modes at both speeds.

The Ethernet controllers are PCI Plug and Play devices. You do not need to set any jumpers or configure the controllers for your operating system before you use the Ethernet controllers. However, you must install a device driver to enable your operating system to address the Ethernet controllers. The device drivers are provided on the ServerGuide CDs.

### Failover for redundant Ethernet

The IBM 10/100 Ethernet Adapter or the IBM 10/100 EtherJet™ PCI family of adapters are optional redundant network interface cards (NICs) that you can install in your server. If you install this NIC and connect it to the same logical segment as the primary Ethernet controller, you can configure the server to support a *failover* function. You can configure either one of the integrated Ethernet controllers or the NIC as the primary Ethernet controller. In failover mode, if the primary Ethernet controller detects a link failure, all Ethernet traffic associated with it is switched to the redundant (secondary) controller. This switching occurs without any user intervention. When the primary link is restored to an operational state, the Ethernet traffic switches back to the primary Ethernet controller.

## High Performance Ethernet Modes

Your Ethernet controllers support optional modes, such as teaming, priority packets, and virtual LANs, which provide higher performance and throughput for your server.

**Teaming Mode:** Your Ethernet controllers provide options, called *teaming options*. These options increase throughput and fault tolerance when running with Windows NT 4.0 or NetWare 4.1x or later.

- **Adapter fault tolerance (AFT)** provides automatic redundancy for your adapter. If the primary adapter fails, the secondary adapter takes over. Adapter fault tolerance supports from 2 to 4 adapters per team.
- **Adaptive load balancing (ALB)** enables you to balance the transmission data flow among 2 to 4 adapters. ALB also includes the AFT option. You can use ALB with any 100BASE-TX switch.
- **Cisco Fast EtherChannel (FEC)** creates a team of 2 to 4 adapters to increase transmission and reception throughput. FEC also includes the AFT option. You can only use FEC with a switch that has FEC capability.

Teaming requires you to install both integrated Ethernet controllers. For additional information about the teaming modes, refer to the documentation that comes with these additional adapters.

**Priority Packet Mode:** Priority Packet is a traffic-prioritization utility that enables you to set up filters to process high-priority traffic before normal traffic. You can send information from critical nodes or applications with an indicated priority. Because you set this priority at the host or entry point of the network, the network devices can base forwarding decisions on priority information defined in the packet.

Priority Packet information is available on the IBM Networking Web site at: <http://www.ibm.com/networking/support>.

Priority Packet prioritizes traffic based on priority filters. These are parameters you assign to outgoing (transmit) packets. Using the Priority Filter Wizard, you can set up predefined or custom priority filters based on a node (MAC) address, Ethernet type, or by various properties of the protocol and port. Priority Packet provides two different methods for prioritizing traffic: IEEE 802.1p tagging and High Priority Queue. IEEE 802.1p is a new IEEE standard for tagging, or adding additional bytes of information to packets with different priority levels. Packets are tagged with 4 additional bytes, which increase the packet size and indicate a priority level. When you send these packets out on the network, the higher priority packets are transferred first. Priority packet tagging (also known as Traffic Class Expediting) enables the adapter to work with other elements of the network (such as switches and routers) to deliver priority packets first. You can assign specific priority levels from 0 (low) to 7 (high).

You can assign values to packets based on their priority when you use the IEEE 802.1p standard for packet tagging. This method requires a network infrastructure that supports packet tagging. The routing devices receiving and transferring these packets on your network must support 802.1p for tagging to be effective.

After you set up the priority filter in Priority Packet, you must launch IBMSet and select **802.1p/802.1Q Tagging** on the Advanced tab.

**Note:** IEEE 802.1p tagging increases the size of the packets it tags. Some hubs and switches will not recognize the larger packets and will drop them. Check your hub or switch documentation to see if they support 802.1p. (You can configure the switch to strip the tags from the packets and send it on to the next destination as normal traffic). If these devices do not support 802.1p or if you are not sure, use High Priority Queue (HPQ) to prioritize network traffic.

The requirements for effectively using IEEE 802.1p tagging are:

- The other devices receiving and routing 802.1p tagged packets must support 802.1p.
- The adapters on these devices must support 802.1p. The Ethernet controller in your server, all IBM Netfinity 10/100 Ethernet Security Adapters, and IBM 10/100 Ethernet Server Adapters support 802.1p.
- The adapter cannot be assigned to an adapter team.
- If you are setting up Plans and packet tagging on the same adapter, 802.1p/802.1Q Tagging must be enabled on the IBMSet Advanced tab.

If your network infrastructure devices do not support IEEE 802.1p or you are not sure, you can still define filters and send packets as high priority. While High Priority Queue (HPQ) does not provide the precise priority levels of 802.1p tagging, it does assign traffic as either high or low priority and sends high priority packets first. Therefore, if there are multiple applications on a system sending packets, the packets from the application with a filter are sent out first. HPQ does not change network routing, nor does it add any information to the packets.

To assign HPQ, you can specify it using Priority Packet when you create or assign a filter.

To effectively use HPQ, the adapter cannot be assigned to an adapter team.

**Virtual LAN Mode:** A virtual LAN (VLAN) is a logical grouping of network devices put together as a LAN, regardless of their physical grouping or collision domains. Using Plans increases network performance and improves network security.

Vlans offer you the ability to group users and devices together into logical workgroups. This can simplify network administration when connecting clients to servers that are geographically dispersed across the building, campus, or enterprise network.

Normally, Vlans are configured at the switch and any computer can be a member of one VLAN per installed network adapter. Your Ethernet controller supersedes this by communicating directly with the switch, allowing multiple VLANs on a single network adapter (up to 64 VLANs).

To set up VLAN membership, your Ethernet controller must be attached to a switch that has VLAN capability. You also need to use Windows NT 4.0 or later, or Novell NetWare 4.1x or later.

**Notes:**

1. Windows NT versions prior to 4.0 do not support VLANs.
2. VLANs require NT 4.0 with Service Pack 3.0 and the NDIS driver from Microsoft.
3. In Windows NT, VLANs cannot be implemented on controllers that have been configured for teaming options. NetWare can support teaming options and VLANs on the same adapters.

To join a VLAN from Windows NT 4.0:

1. Create a VLAN on the switch. Use the parameters you assign there to join the VLAN from the server. Refer to your switch documentation for more information.
2. Double-click the Network icon in the Control Panel window.
3. On the Adapters tab, select the adapter you want to be on the VLAN and select **Properties**.
4. In IBMSet, select **Join VLAN**. Note that VLANs cannot be assigned to adapters that are already defined to have an adapter teaming option.
5. Enter the VLAN ID and VLAN name. The VLAN ID must match the VLAN ID of the switch. The ID range is from 1 to 1000. The VLAN name is for information only and does not need to match the name on the switch.
6. Select **Join VLAN**. Repeat steps 3 through 5 for each VLAN you want the server to join. The VLANs you add are listed on the Adapters tab.
7. Select **Close** and restart the computer.

**Ethernet port connector**

The following table and illustration show the pin-number assignments for the RJ-45 connector. These assignments apply to both 10BASE-T and 100BASE-TX devices.

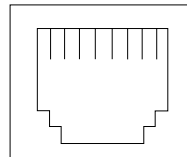

Table 7. Ethernet RJ-45 connector pin-number assignments..

Pin	Signal	Pin	Signal
1	Transmit data+	5	Not connected
2	Transmit data-	6	Receive data -
3	Receive data+	7	Not connected
4	Not connected	8	Not connected

---

## Chapter 6. Solving problems

This section provides basic troubleshooting information to help you resolve some common problems that might occur with your system.

If you cannot locate and correct the problem using the information in this section, refer to “Getting help, service, and information” on page 93 for more information.

---

### Diagnostic tools overview

The following tools are available to help you identify and resolve hardware-related problems:

- **POST beep codes**

The power-on self-test beep codes indicate the detection of a problem. See “POST beep code descriptions” on page 57 for more information.

- **Diagnostic programs and error messages**

The system diagnostic programs are provided on the *IBM Enhanced Diagnostics* CD. These programs test the major components of your server. See “Diagnostic programs and error messages” on page 68 for more information.

- **Troubleshooting charts**

These charts list problem symptoms and steps to correct the problems. See the “Troubleshooting charts” on page 79 for more information.

- **Customized support page**

You can create a customized support page on the World Wide Web that is specific to your hardware, including frequently asked questions, parts information, technical hints and tips, and downloadable files. In addition, you can choose to receive electronic mail (e-mail) notifications whenever new information becomes available about your registered products.

After you register and profile your xSeries 300, you can diagnose problems using the IBM Online Assistant, and you can participate in the IBM discussion forum. For more detailed information about registration and creating a customized profile for your IBM products, visit the following addresses on the Web:

- <http://www.ibm.com/pc/register>
- <http://www.ibm.com/pc/support>

# Server Support

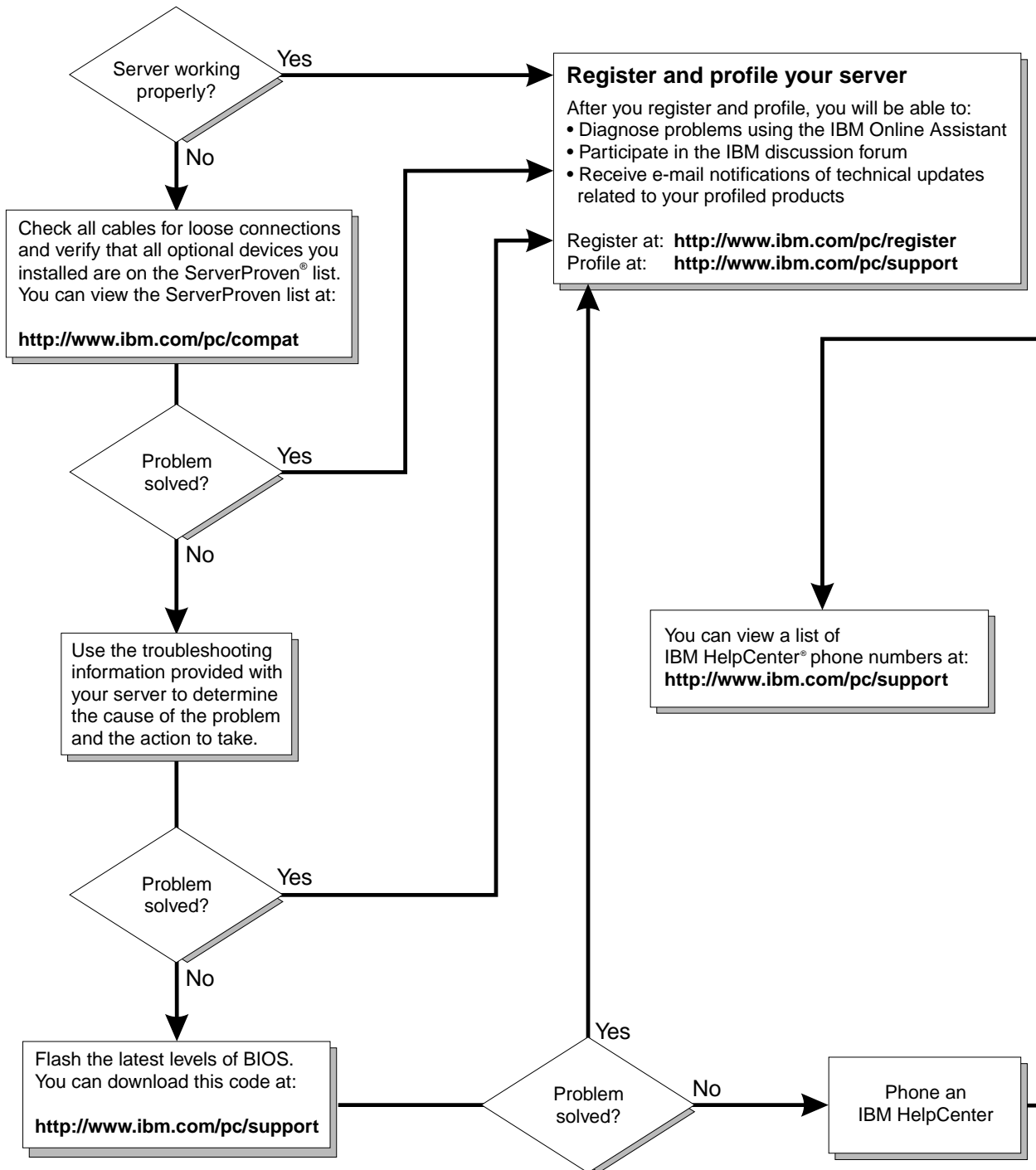

---

# POST

When you turn on the server, it performs a series of tests to check the operation of system components and some of the options that are installed in the server. This series of tests is called the power-on self-test, or POST.

If POST finishes without detecting any problems, the first window of your operating system or application program appears.

**Notes:**

1. If you have a power-on password set, you must type the password and press Enter, when prompted, before POST will continue.
2. A single problem might cause several error messages. When this occurs, work to correct the cause of the first error message. After you correct the cause of the first error message, the other error messages usually will not occur the next time you run the test.

## POST beep code descriptions

Beep codes are sounded in a series of beeps. For example, a 1-2-4 beep code sounds like one beep, a pause, two consecutive beeps, another pause, and four more consecutive beeps.

The possible types of beep codes that your server might emit include the following:

**No beeps**

If no beep occurs after your server completes POST, call for service.

**Continuous beep**

Your startup (boot) microprocessor has failed, or your system board or speaker subsystem might contain a failing component. If the system continues through POST with no errors, call for service. If no video appears, the startup processor has failed; replace the startup processor.

**One short beep**

One beep indicates that your server successfully completed POST. POST detected no configuration or functional errors. One beep also occurs after your server completes POST if you enter an incorrect power-on password.

**Two short beeps**

POST encountered an error. The Configuration/Setup Utility program will display additional information; follow the instructions that appear on the screen. See "POST error messages" on page 60 for descriptions of the text messages that might appear.

**Three short beeps**

A system memory error has occurred. This combination occurs only if the video Basic Input/Output System (BIOS) cannot display the error message. Replace the failing memory module.

**Repeating short beeps**

The system board might contain a failing component, your keyboard might be defective, or a key on the keyboard might be stuck. Ensure that:

1. Nothing is resting on the keyboard and pressing a key.
2. No key is stuck.
3. The keyboard cable is connected correctly to the keyboard and to the correct connector on the server.

Running the diagnostic tests can isolate the server component that failed, but you must have your system serviced. If the error message remains, call for service.

**Note:** If you just connected a new mouse or other pointing device, turn off the server and disconnect that device. Wait at least 5 seconds; then, turn on the server. If the error message goes away, replace the device.

**One long and one short beep**

POST encountered an error on a video adapter. If you are using the integrated video controller, call for service. If you are using an optional video adapter, replace the failing video adapter.

**One long and two short beeps**

A video I/O adapter ROM is not readable, or the video subsystem is defective. If you hear this beep combination twice, both the system board and an optional video adapter have failed the test. This beep combination might also indicate that the system board contains a failing component.

**One long and three short beeps**

The system-board video subsystem has not detected a monitor connection to the server. Ensure that the monitor is connected to the server. If the problem persists, replace the monitor.

**Two long and two short beeps**

POST does not support the optional video adapter. This beep combination occurs when you install a video adapter that is incompatible with your server. Replace the optional video adapter with one that the server supports or use the integrated video controller.



Table 8. POST beep codes.

Beep Code	Description	Action	
1-1-2	Microprocessor register test has failed.		
1-1-3	CMOS write/read test has failed.		
1-1-4	BIOS ROM checksum has failed.		
1-2-1	Programmable Interval Timer test has failed.		
1-2-2	DMA initialization has failed.		
1-2-3	DMA page register write/read test has failed.		
1-4-3	Interrupt vector loading test has failed.		
2-1-1	Secondary DMA register test has failed.		
2-1-2	Primary DMA register test has failed.		
2-1-3	Primary interrupt mask register test has failed.		
2-1-4	Secondary interrupt mask register test has failed.		
2-2-1	Interrupt vector loading has failed.		
2-2-2	Keyboard controller test has failed.		
2-2-3	CMOS power failure and checksum checks have failed.		
2-2-4	CMOS configuration information validation has failed.		
2-3-2	Screen memory test has failed.		
2-3-3	Screen retrace tests have failed.		
2-3-4	Search for video ROM has failed.		
2-4-1	Screen test indicates the screen is operable.		
3-1-1	Timer tick interrupt test has failed.		
3-1-2	Interval timer channel 2 test has failed.		
3-1-3	RAM test has failed above address hex 0FFFF.		
3-1-4	Time-of-Day clock test has failed.		
3-2-1	Serial port test has failed.		
3-2-2	Parallel port test has failed.		
3-2-4	Comparison of CMOS memory size against actual has failed.		
3-3-2	I2C bus has failed.		
2-3-1	Screen initialization has failed.		Turn off the server and then restart the server. If the problem remains, call for service.

## POST error messages

The following tables provide information about the POST error messages that can appear during startup.

POST message	Description
062	<p>The server failed to boot on three consecutive attempts.</p> <p>All caches are disabled. Repeatedly turning the server on and then off or resetting the server might cause this problem.</p> <p><b>Action:</b> Start the Configuration/Setup Utility program and verify that all settings are correct. Use the <b>Cache Control</b> selection in the Advanced Setup menu of the Configuration/Setup Utility program to enable the caches.</p> <p>If the problem remains, call for service. When the problem is corrected, be sure to enable the caches.</p>
101 102 106	<p>An error occurred during the system board and microprocessor test.</p> <p><b>Action:</b> Call for service.</p>
114	<p>An adapter read-only memory (ROM) error occurred.</p> <p><b>Action:</b> Remove the options. If you can start the server without the options installed, reinstall each option one at a time and retest after each is reinstalled. When an option fails, replace it.</p> <p>If you cannot isolate and correct the problem, call for service.</p>
129	<p>An error was detected in the L1 cache of one of the microprocessors.</p> <p><b>Action:</b> 1. If you just installed a microprocessor, verify that the microprocessor is installed and seated correctly. 2. If the problem remains, call for service.</p>
151	<p>A real-time clock (RTC) error occurred.</p> <p><b>Action:</b> Call for service.</p>
161	<p>The real-time clock battery has failed.</p> <p><b>Action:</b> Replace the battery yourself or call for service.</p> <p>You can use the server until you replace the battery. However, you must run the Configuration/Setup Utility program and set the time and date and other custom settings each time you turn on the server.</p>

Table 9. POST error messages.

POST message	Description
162	<p>A change in device configuration occurred. This error occurs under one or more of the following conditions:</p> <ul style="list-style-type: none"> <li>• A new device has been installed.</li> <li>• A device has been moved to a different location or cable connection.</li> <li>• A device has been removed or disconnected from a cable.</li> <li>• A device is failing and is no longer recognized by the server as being installed.</li> <li>• An external device is not turned on.</li> <li>• An invalid checksum is detected in the battery-backed memory.</li> </ul> <p><b>Action:</b> Verify that all external devices are turned on. You must turn on external devices before turning on the server.</p> <p>If you did not add, remove, or change the location of a device, a device is probably failing. Running the Diagnostic program might isolate the failing device.</p> <p>If you cannot isolate and correct the problem, call for service.</p>
163	<p>The time of day has not been set.</p> <p><b>Action:</b> Set the correct date and time. If the date and time are set correctly and saved, but the 163 error message reappears, call for service.</p> <p>You can use the server until the system is serviced, but any application programs that use the date and time will be affected.</p>
164	<p>A change in the memory configuration occurred. This message might appear after you add or remove memory.</p> <p><b>Note:</b> The server can be used with decreased memory capacity.</p> <p><b>Action:</b> 1. If POST error message 289 also occurred, follow the instructions for that error message first.</p> <p style="padding-left: 40px;">2. If you just installed or removed memory, run the Configuration/Setup Utility program; then, exit, saving the new configuration settings.</p> <p style="padding-left: 40px;">If the message appears again, shut down the server, reseal the memory modules, and restart the server.</p> <p>If the problem remains, call for service.</p>
175	<p>A vital product data (VPD) error occurred.</p> <p><b>Action:</b> Call for service.</p>
176 177 178	<p>A security hardware error occurred.</p> <p><b>Action:</b> Check for indications that someone has tampered with the server. If no one has tampered with the server, call for service.</p>
184	<p>The power-on password information stored in your server has been removed.</p> <p><b>Action:</b> From the Configuration/Setup Utility program main menu, select <b>System Security</b>. Then, follow the instructions on the screen.</p> <p>If this information cannot be restored, call for service.</p>
185	<p>A power failure damaged the stored information about the drive-startup sequence.</p> <p><b>Action:</b> From the Configuration/Setup Utility program main menu, select <b>Start Options</b>; then, follow the instructions on the screen.</p> <p>If this information cannot be restored, call for service.</p>

Table 9. POST error messages.

POST message	Description
186	A system board or hardware error occurred. <b>Action:</b> Call for service.
187	The VPD serial number is not set. <b>Action:</b> The system serial number is set in the VPD EEPROM at the time of manufacturing. If the system board has been replaced, the system serial number will be invalid and should be set. From the main menu of the Configuration/Setup Utility program, select <b>System Information</b> , then select <b>Product Data</b> . If the problem remains, call for service.
188	A vital product data (VPD) error occurred. <b>Action:</b> Call for service.
189	An attempt has been made to access the server with invalid passwords. After three incorrect attempts, the server locks up; that is, the logon data fields are no longer available to the user.
201	An error occurred during the memory controller test. This error can be caused by: <ul style="list-style-type: none"> <li>• Incorrectly installed memory</li> <li>• A failing memory module</li> <li>• A system board problem</li> </ul> <b>Action:</b> 1. If you just installed memory, verify that the new memory is correct for your server. Also verify that the memory is installed and seated correctly. 2. If the problem remains, call for service.
229	An error was detected in the L2 cache of one of the microprocessors. <b>Action:</b> 1. If you just installed a microprocessor, verify that the microprocessor is installed and seated correctly. 2. If the problem remains, call for service.
289	An error occurred during POST memory tests and a failing DIMM was disabled. <b>Note:</b> You can use the server with decreased memory. <b>Action:</b> 1. If you just installed memory, verify that the new memory is correct for your server. Also verify that the memory is installed and seated correctly. Start the Configuration/Setup Utility program and select <b>Memory Settings</b> from the Advanced Setup menu to enable the DIMM. 2. If the problem remains, replace the failing DIMM.  If the problem remains, call for service.
301 303	An error occurred during the keyboard and keyboard controller test. These error messages also might be accompanied by continuous beeping. <b>Action:</b> Ensure that: <ol style="list-style-type: none"> <li>1. Nothing is resting on the keyboard and pressing a key.</li> <li>2. No key is stuck.</li> <li>3. The keyboard cable is connected correctly to the keyboard and to the correct connector on the server.</li> </ol> Running the diagnostic tests can isolate the server component that failed, but you must have your system serviced. If the error message remains, call for service. <b>Note:</b> If you just connected a new mouse or other pointing device, turn off the server and disconnect that device. Wait at least 5 seconds; then, turn on the server. If the error message goes away, replace the device.

Table 9. POST error messages.

POST message	Description
602	<p>Invalid diskette boot record</p> <p><b>Action:</b></p> <ol style="list-style-type: none"> <li>1. Replace the diskette.</li> <li>2. If the problem persists, make sure that the diskette drive cables are correctly and securely connected.</li> <li>3. If the problem remains, replace the diskette drive.</li> </ol> <p>If the problem remains, call for service.</p>
604	<p>An error occurred during a diskette drive test.</p> <p><b>Action:</b></p> <ol style="list-style-type: none"> <li>1. Verify that the Configuration/Setup Utility program correctly reflects the type of diskette drive that you have installed.</li> <li>2. Run the diagnostic tests. If the diagnostic tests fail, call for service.</li> </ol>
662	<p>A diskette drive configuration error occurred.</p> <p><b>Action:</b> If you removed a diskette drive, make sure that the diskette drive setting is correct in the Configuration/Setup Utility program. If the setting is not correct, change it.</p> <p>If the problem remains, call for service.</p>
962	<p>A parallel port configuration error occurred.</p> <p><b>Action:</b> If you changed a hardware option, make sure that the parallel port setting is correct in the Configuration/Setup Utility program. If the setting is not correct, change it.</p> <p>If the problem remains, call for service.</p>
11xx	<p>An error occurred during the system-board serial port test.</p> <p><b>Action:</b> If you have a modem, serial printer, or other serial device attached to your server, verify that the serial cable is connected correctly. If it is, use the following procedure:</p> <ol style="list-style-type: none"> <li>1. Turn off the server.</li> <li>2. Disconnect the serial cable from the serial port.</li> <li>3. Wait five seconds; then, turn on the server.</li> </ol> <p>If the POST error message does not reappear, either the serial cable or the device is probably failing. See the documentation that comes with the serial device for additional testing information.</p> <p>If the POST error message reappears, call for service.</p>
1162	<p>The serial port configuration conflicts with another device in the system.</p> <p><b>Action:</b></p> <ol style="list-style-type: none"> <li>1. Make sure the IRQ and I/O port assignments needed by the serial port are available.</li> <li>2. If all interrupts are being used by adapters, you might need to remove an adapter to make an interrupt available to the serial port, or force other adapters to share an interrupt.</li> </ol>
1600	<p>The Advanced System Management processor is not functioning.</p> <p><b>Action:</b></p> <ol style="list-style-type: none"> <li>1. Verify that the jumpers for the system-management processor are set correctly.</li> <li>2. Disconnect the server from all electrical sources, wait for 30 seconds, reconnect the server to the electrical sources, and restart the server.</li> </ol> <p>If the problem remains, call for service.</p>
1601	<p>An Advanced System Management Flash update is needed.</p> <p><b>Action:</b> Download and install the latest Advanced System Management flash update.</p>

Table 9. POST error messages.

POST message	Description
1800	<p>A PCI adapter has requested a hardware interrupt that is not available.</p> <p><b>Action:</b></p> <ol style="list-style-type: none"> <li>1. Make sure that the PCI adapter and all other adapters are set correctly in the Configuration/Setup Utility program. If the interrupt resource settings are not correct, change the settings.</li> <li>2. If all interrupts are being used by other adapters, you might need to remove an adapter to make an interrupt available to the PCI adapter, or force other adapters to share an interrupt.</li> </ol>
1962	<p>No valid startup devices were found. The system cannot find the startup drive or operating system.</p> <p><b>Action:</b> Be sure that the drive you want to start from is in the startup sequence.</p> <ol style="list-style-type: none"> <li>1. Select <b>Start Options</b> from the Configuration/Setup Utility program main menu. If you are unable to set the startup sequence, call for service.</li> <li>2. Check the list of startup devices in the <b>Startup device</b> data fields. Is the drive you want to start from in the startup sequence? <ul style="list-style-type: none"> <li><b>Yes</b> Exit from this screen; then, select <b>Exit Setup</b> to exit the Configuration/Setup menu. Go to step 3..</li> <li><b>No</b> Follow the instructions on the screen to add the drive; then, save the changes and exit the Configuration/Setup menu. Restart the server.</li> </ul> </li> <li>3. Is an operating system installed? <ul style="list-style-type: none"> <li><b>Yes</b> Turn off the server. Go to step 4..</li> <li><b>No</b> Install the operating system in your server; then, follow your operating system instructions to shut down and restart the server.</li> </ul> </li> <li>4. During server startup, watch for messages indicating a hardware problem.</li> </ol> <p>If the same error message appears, call for service.</p>
2400	<p>An error occurred during the testing of the video controller on the system board. This error can be caused by a failing monitor, a failing system board, or a failing video adapter (if one is installed).</p> <p><b>Action:</b> Verify that the monitor is connected correctly to the video connector. If the monitor is connected correctly, call for service.</p>
2462	<p>A video memory configuration error occurred.</p> <p><b>Action:</b> Make sure that the monitor cables are correctly and securely connected to the server.</p> <p>If the problem remains, call for service.</p>
5962	<p>An IDE CD-ROM configuration error occurred.</p> <p><b>Action:</b> Check the signal and power cable connections to the CD-ROM drive.</p> <p>If the problem remains, call for service.</p>

Table 9. POST error messages.

POST message	Description
8603	<p>An error occurred during the mouse (pointing device) controller test. The addition or removal of a mouse, or a failing system board can cause this error.</p> <p><b>Note:</b> This error also can occur if electrical power was lost for a very brief period and then restored. In this case, turn off the server for at least 5 seconds; then, turn it back on.</p> <p><b>Action:</b> Ensure that the keyboard and mouse (pointing device) are attached to the correct connectors. If they are connected correctly, use the following procedure:</p> <ol style="list-style-type: none"> <li>1. Turn off the server.</li> <li>2. Disconnect the mouse from the server.</li> <li>3. Turn on the server.</li> </ol> <p>If the POST error message does not reappear, the mouse is probably failing. See the documentation that comes with the mouse for additional testing information. If the problem remains, replace the mouse or pointing device.</p> <p>If the POST error message reappears, run the diagnostic tests to isolate the problem. If the diagnostic tests do not find a problem and the POST error message remains, call for service.</p>
00012000	<p>Processor machine check.</p> <p><b>Action:</b></p> <ol style="list-style-type: none"> <li>1. Update the system BIOS.</li> <li>2. If the problem persists, replace the microprocessor.</li> </ol>
00019501	<p>Processor 1 is not functioning.</p> <p><b>Action:</b> Replace microprocessor 1.</p> <p>If the problem remains, call for service.</p>
00019502	<p>Processor 2 is not functioning.</p> <p><b>Action:</b> Replace microprocessor 2.</p> <p>If the problem remains, call for service.</p>
00019701	<p>Processor 1 failed the built-in self test.</p> <p><b>Action:</b> Replace microprocessor 1.</p> <p>If the problem remains, call for service.</p>
00019702	<p>Processor 2 failed the built-in self-test.</p> <p><b>Action:</b> Replace microprocessor 2.</p> <p>If the problem remains, call for service.</p>
00180100	<p>A PCI adapter has requested memory resources that are not available</p> <p><b>Action:</b></p> <ol style="list-style-type: none"> <li>1. Make sure that the PCI adapter and all other adapters are set correctly in the Configuration/Setup Utility program. If the memory resource settings are not correct, change the settings.</li> <li>2. If all memory resources are being used, you might need to remove an adapter to make memory available to the PCI adapter. Disabling the adapter BIOS on the adapter might correct the error. Refer to the documentation provided with the adapter.</li> </ol>

Table 9. POST error messages.

POST message	Description
00180200	<p>A PCI adapter has requested an I/O address that is not available, or the PCI adapter might be defective.</p> <p><b>Action:</b></p> <ol style="list-style-type: none"> <li>1. Make sure that the I/O address for the PCI adapter and all other adapters are set correctly in the Configuration/Setup Utility program.</li> <li>2. If the I/O port resource settings are correct, the PCI adapter might be defective. Call for service.</li> </ol>
00180300	<p>A PCI adapter has requested a memory address that is not available, or the PCI adapter might be defective.</p> <p><b>Action:</b></p> <ol style="list-style-type: none"> <li>1. Make sure that the memory address for all other adapters are set correctly in the Configuration/Setup Utility program. If the memory resource settings are not correct, change the settings.</li> <li>2. If the memory resource settings are correct, the PCI adapter might be defective. Call for service.</li> </ol>
00180400	<p>A PCI adapter has requested a memory address that is not available.</p> <p><b>Action:</b> If all memory addresses are being used, you might need to remove an adapter to make memory address space available to the PCI adapter. Disabling the adapter BIOS on the adapter might correct the error. Refer to the documentation provided with the adapter.</p>
00180500	<p>A PCI adapter ROM error occurred.</p> <p><b>Action:</b> Remove the PCI adapters. If you can start the server without the adapters, reinstall each adapter one at a time and retest after each is reinstalled. When an adapter fails, replace it.</p> <p>If you cannot isolate and correct the problem, call for service.</p>
00180600	<p>A PCI-to-PCI bridge error occurred. More than one PCI bus tried to access memory below 1 MB.</p> <p><b>Action:</b> Remove the PCI adapter that has the PCI bridge. If you can start the server without the adapter, reinstall and retest the adapter. If the adapter fails, replace it.</p> <p>If you cannot isolate and correct the problem, call for service.</p>
00180700	<p>xxxxyyyy Planar PCI device does not respond or disabled by user. (Where xxxx is the PCI vendor ID and yyyy is the PCI device ID.)</p> <p><b>Action:</b> Start the Configuration/Setup Utility program, select Devices and I/O Ports, and make sure that the device is enabled. If the problem remains, call for service.</p>
00180800	<p>An unsupported PCI device is installed.</p> <p><b>Action:</b> Remove the PCI adapters. If you can start the server without the adapters, reinstall each adapter one at a time and retest after each is reinstalled. When an adapter fails, replace it.</p> <p>If the problem remains, call for service.</p>
00181000	<p>PCI error.</p> <p><b>Action:</b> Remove the PCI adapters. If you can start the server without the adapters, reinstall each adapter one at a time and retest after each is reinstalled. When an adapter fails, replace it.</p> <p>If the problem remains, call for service.</p>
01295085	<p>The ECC checking hardware test failed.</p> <p><b>Action:</b> Call for service.</p>

Table 9. POST error messages.



POST message	Description
01298001	No update data is available for processor 1. <b>Action:</b> Update the system BIOS to a level that supports the microprocessors installed in the server.
01298002	No update data is available for processor 2. <b>Action:</b> Update the system BIOS to a level that supports the microprocessors installed in the server.
01298101	The update data for processor 1 is incorrect. <b>Action:</b> Update the system BIOS to a level that supports the microprocessors installed in the server.
01298102	The update data for processor 2 is incorrect. <b>Action:</b> Update the system BIOS to a level that supports the microprocessors installed in the server.
01298200	Microprocessor speed mismatch <b>Action:</b> The microprocessors installed do not run at the same speed; install microprocessors with identical speeds.
I9990301	A hard disk drive error occurred. <b>Action:</b> Call for service.
I9990305	POST could not find an operating system. <b>Action:</b> Install an operating system. If you have already installed the operating system, check the drive startup sequence. If the drive sequence is correct, run the diagnostic tests to verify that the hard disk drive is functioning correctly. If there is a problem with the hard disk drive (such as a bad sector), you might need to reinstall the operating system.  If you cannot reinstall the operating system, call for service.
I9990650	AC power has been restored. <b>Action:</b> No action is required. This message appears each time AC power is restored to the server after an AC power loss.
Other Numbers	POST found an error. <b>Action:</b> Follow the instructions on the screen.

Table 9. POST error messages.

---

## Small computer system interface messages (some models)

If you receive a SCSI error message while using the SCSISelect Utility, use the following list to determine the possible cause of the error and what action to take.

**Note:** If your system does not have a hard disk drive, ignore any message that indicates that the BIOS code is not installed.

One or more of the following might be causing the problem.

- A failing SCSI device (adapter or drive)
- An improper SCSI configuration
- Duplicate SCSI IDs in the same SCSI chain
- An improperly installed SCSI terminator
- A defective SCSI terminator
- An improperly installed cable
- A defective cable

**Action:**

Verify that:

- The external SCSI devices are turned on. External SCSI devices must be turned on *before* the server.
- The cables for all external SCSI devices are connected correctly.
- The last device in each SCSI chain is terminated properly.
- The SCSI devices are configured correctly.

If the above items are correct, run the diagnostic programs to obtain additional information about the failing device. If the error remains or recurs, call for service.

---

## Diagnostic programs and error messages

The system diagnostic programs are stored on the *IBM Enhanced Diagnostics CD*. These programs provide the primary methods of testing the major components of your server.

Diagnostic error messages indicate that a problem exists; they are not intended to be used to identify a failing part. Troubleshooting and servicing of complex problems that are indicated by error messages should be performed by trained service personnel.

Sometimes the first error to occur causes additional errors. In this case, the server displays more than one error message. Always follow the suggested action instructions for the *first* error message that appears.

The following sections contain the error codes that might appear in the detailed test log and summary log, when running the diagnostic programs.

The error code format is as follows:

fff-ttt-iii-date-cc-text message

where:

**fff** is the three-digit function code that indicates the function being tested when the error occurred. For example, function code 089 is for the microprocessor.

- ttt** is the three-digit failure code that indicates the exact test failure that was encountered. (These codes are for trained service personnel and are described in the *Hardware Maintenance Manual*.)
- iii** is the three-digit device ID. (These codes are for trained service personnel and are described in the *Hardware Maintenance Manual*.)
- date** is the date that the diagnostic test was run and the error recorded.
- cc** is the check value that is used to verify the validity of the information.
- text message** is the diagnostic message that indicates the reason for the problem.

## Text messages

The diagnostic text message format is as follows:

Function Name: Result (test specific string)

where:

### Function Name

is the name of the function being tested when the error occurred. This corresponds to the function code given in the “Diagnostic error message tables” on page 72.

**Result** can be one of the following:

<b>Passed</b>	This result occurs when the diagnostic test completes without any errors.
<b>Failed</b>	This result occurs when the diagnostic test discovers an error.
<b>User Aborted</b>	This result occurs when you stop the diagnostic test before it is complete.
<b>Not Applicable</b>	This result occurs when you specify a diagnostic test for a device that is not present.
<b>Aborted</b>	This result occurs when the test could not proceed because of the system configuration.
<b>Warning</b>	This result occurs when a possible problem is reported during the diagnostic test, such as when a device that is to be tested is not installed.
<b>Test Specific String</b>	This is additional information that is used to analyze the problem.

## Starting the diagnostic programs

The IBM Enhanced Diagnostics programs will isolate your server hardware from software that you have installed on your hard disk drive. The programs run independently of the operating system, and *must be run either from the CD or diskette*. This method of testing is generally used when other methods are not accessible or have not been successful in isolating a problem suspected to be hardware related.

An *IBM Enhanced Diagnostics* CD comes with your server. You can also download the latest image of the diagnostics from <http://www.ibm.com/pc/support> on the World Wide Web.

## Using the diagnostics CD

To start the IBM Enhanced Diagnostics using the CD, do the following:

1. Turn off your server and any peripheral devices.
2. Turn on all attached devices; then, turn on your server.
3. When *Press F1 For Configuration/Setup* appears, press the F1 key.
4. When the Configuration/Setup Utility menu appears, select **Start Options**.
5. From the Start Options menu, select **Startup Sequence**.
6. Note the device selected as the First Startup Device. Later, you must restore this setting.
7. Select **CD-ROM** as the First Startup Device.
8. Press Esc two times to return to the Configuration/Setup Utility menu.
9. Place the *IBM Enhanced Diagnostics* CD in the CD-ROM drive.
10. Select **Save & Exit Setup** and follow the prompts. The diagnostics will load. Follow the instructions on the screen to run the diagnostics.

### Important:

When you finish running the diagnostics, remove the CD from the CD-ROM drive and turn off the server. You must restore the First Startup Device to the original setting. Use steps 2 through 8 of this procedure to do this.

## Downloading the diagnostics program

Complete the following steps to download the latest image of the IBM Enhanced Diagnostics from the World Wide Web and create a startable Enhanced Diagnostics diskette:

1. Go to the following World Wide Web site: <http://www.ibm.com/pc/support/>
2. Download the diagnostics file for your server to a hard disk drive directory (not to a diskette).
3. Go to a DOS prompt and change to the directory where the file was downloaded.
4. Insert a blank high-density diskette in diskette drive A.
5. Type `filename a:` where *filename* is the name of the file you downloaded from the Web, and press Enter.

The downloaded file is self-extracting and will be copied to the diskette. When the copy completes, you have a startable IBM Enhanced Diagnostics diskette.

## Using the diagnostic diskette

Complete the following steps to start the IBM Enhanced Diagnostics using the diagnostics diskette:

1. Turn off your server and any peripheral devices.
2. Insert the IBM Enhanced Diagnostics diskette into the diskette drive.
3. Turn on the peripheral devices; then, turn on your server.
4. Follow the instructions on the screen.

When the tests have completed, you can view the test log by selecting **Utility** from the top of the screen.

If the test indicate that the hardware is working properly but the problem persists during normal server operations, a software error might be the cause. If you suspect a software problem, refer to the information that comes with the software package.

## Viewing the test log

The test log records data about system failures and other pertinent information. The test log will not contain any information until after the diagnostic program has run.

**Note:** If you already are running the diagnostic programs, begin with step 4.

Do the following to view the test log:

1. Insert the *IBM Enhanced Diagnostics* CD or diskette.
2. Turn on the system and watch the screen.  
If the system is on, shut down your operating system and restart the system.
3. If a power-on password is set, the system prompts you for it. Type the appropriate password; then, press Enter.
4. Run the diagnostic programs, and when the Diagnostic Programs screen appears, select **Utility**.
5. Select **View Test Log** from the list that appears; then, follow the instructions on the screen. You can save the test log to a file on a diskette or to your hard disk drive.

**Note:** The system maintains the test-log data while the system is powered on. When you turn off the power to the server, the test log is cleared.

## Diagnostic error message tables

The following tables provide descriptions of the error messages that might be listed in the test log after you run the diagnostic programs.

Code	Function	Result	Text message	Action
001	Core system	Failed	Processor board, ECC Test	Call for service.
			System board	
005	Video port		Processor and system boards	
011	Serial port		Integrated serial port	
015	USB interface	Aborted	Cannot test USB interface while it is in use. <b>Note:</b> If you have a USB keyboard or mouse attached, you cannot run the diagnostic program for the USB interface.	N/A
		Failed	System board	<ol style="list-style-type: none"> <li>1. Turn off the system.</li> <li>2. Replace the USB keyboard and mouse with a standard keyboard and mouse.</li> <li>3. Turn on the system.</li> <li>4. Run the diagnostic test again.</li> </ol>
020	PCI interface	Failed	System board	Call for service.
030	SCSI interface	Failed	SCSI adapter in slot <i>n</i> failed register/counter/power test  (where <i>n</i> is the slot number of the failing adapter)	Refer to the information provided with the adapter for instructions.  If the problem remains, call for service.
			SCSI controller on system board failed register/counter/power test	Call for service.
075	Power supply	Failed	Voltage sensed by the system is out of range	Call for service.

Code	Function	Result	Text message	Action
089	Microprocessor	Failed	Invalid microprocessor in slot xyz or BIOS setup problem  (where xyz identifies the microprocessor that is causing the error message)	<ol style="list-style-type: none"> <li>1. Check the system error log for the related error messages.</li> <li>2. If your system does not have the latest level BIOS installed, update the BIOS.</li> <li>3. If the problem remains, replace the xyz microprocessor and run the test again.</li> </ol> <p>If the problem remains, call for service.</p>
			Processor in socket id xyz is installed but not functioning  (where xyz identifies the microprocessor that is causing the error message)	
			Microprocessor in socket id xyz  (where xyz identifies the microprocessor that is causing the error message)	<ol style="list-style-type: none"> <li>1. Reseat the microprocessor.</li> <li>2. If the problem remains, replace the microprocessor.</li> </ol> <p>If the problem remains, call for service.</p>
			Processor in socket id xyz is defective  (where xyz identifies the microprocessor that is causing the error message)	<p>Replace the microprocessor.</p> <p>If the problem remains, call for service.</p>
			Test setup error: Application microprocessor not installed or BIOS setup problem	<ol style="list-style-type: none"> <li>1. Verify that the Application microprocessor is installed and seated correctly.</li> <li>2. If your system does not have the latest level BIOS installed, update the BIOS.</li> <li>3. If the problem remains, replace the Application microprocessor and run the test again.</li> </ol> <p>If the problem remains, call for service.</p>

Code	Function	Result	Text message	Action
089	Microprocessor	Failed	VRM corresponding to microprocessor in socket xyz is defective  (where xyz identifies the microprocessor whose VRM is causing the error message)	Replace the VRM.  If the problem remains, call for service.
			VRM corresponding to microprocessor in socket id xyz is not installed  (where xyz identifies the microprocessor whose VRM is causing the error message)	Install a VRM.  If the problem remains, call for service.
175	System thermal	Failed	Fan # <i>n</i>  (where <i>n</i> is the number of the failing fan)	Replace the indicated fan.
			Temperature sensed on processor board is out of range	Call for service.
180	Status display	Failed	Any failure message	Call for service.
201	System memory	Failed	DIMMs in location DIMM <i>n</i>  (where <i>n</i> is the number of the socket that contains the failing DIMM)	<ol style="list-style-type: none"> <li>1. Reseat the failing DIMM.</li> <li>2. If the problem remains, replace the DIMM.</li> </ol> <p>If the problem remains, call for service.</p>
			Test setup error: Corrupt BIOS in ROM	<p>If your system does not have the latest level BIOS installed, update the BIOS to the latest level.</p> <p>If the problem remains, call for service.</p>
			Test setup error: Corrupt DMI BIOS, information in BIOS is not as expected	



Code	Function	Result	Text message	Action
202	System cache	Aborted	Test setup error: BIOS cannot access VPD information	If your system does not have the latest level BIOS installed, update the BIOS to the latest level and run the diagnostic program again.  If the problem remains, call for service.
			Test setup error: Corrupt DMI BIOS, information in BIOS is not as expected	
		Failed	Test setup error: No L2 cache detected on microprocessor socket id xyz or BIOS setup problem  (where xyz identifies the microprocessor that is causing the error message)	1. If your system does not have the latest level BIOS installed, update the BIOS to the latest level  2. Run the diagnostic program again.  3. If the problem remains, replace the failing processor.  If the problem remains, call for service.
			Test setup error: Unknown hardware problem associated with microprocessor in socket id xyz.  (where xyz identifies the microprocessor that is causing the error message)	
Warning	Microprocessor in socket ID xyz  (where xyz identifies the microprocessor that is causing the error message)	1. Reseat the identified microprocessor.  2. If the problem remains, replace the microprocessor.  If the problem remains, call for service.		
			Test setup error: Cache is disabled. Use system setup to enable before retrying the test	Use the <b>Cache Control</b> choice under the Advanced Setup menu, under the Configuration/Setup Utility program main menu, to enable the cache.  If the problem remains, call for service.
206	Diskette drive	Failed	Internal diskette drive bay	Call for service.
215	CD-ROM	Failed	On system board.	Call for service.
		Aborted	The CD-ROM drive is not present.	Verify that the cables are properly connected to the CD-ROM drive. If the problem remains, call for service.
217	Hard disk drive	Failed	BIOS drive # <i>n</i> (where <i>n</i> is the drive bay number)	Call for service.

Code	Function	Result	Text message	Action
301	Keyboard	Failed	On system-board keyboard test failed	<ol style="list-style-type: none"> <li>1. Verify that the keyboard cable is connected.</li> <li>2. If the problem remains, replace the keyboard cable.</li> </ol> <p>If the problem remains, call for service.</p>
302	Mouse	Failed	On system-board pointing device test failed.	Replace the pointing device. If the problem remains, call for service.
305	Video monitor		Any message	Refer to the information that came with the monitor.
405	Ethernet	Failed	In PCI slot <i>n</i>  (where <i>n</i> is the PCI slot number in which the failing Ethernet adapter is installed)	Replace the Ethernet adapter in slot <i>n</i> . If the problem remains, call for service.
			On system board	Call for service.

<b>Code</b>	<b>Function</b>	<b>Result</b>	<b>Text message</b>	<b>Action</b>
415	Analog/digital modem	Not applicable	No modem was detected	<ol style="list-style-type: none"> <li>1. Verify that the modem is properly attached to the system.</li> <li>2. If the problem remains, replace the modem.</li> </ol> <p>If the problem remains, call for service.</p>
			PCI modem detected, but not enabled	<ol style="list-style-type: none"> <li>1. Change the configuration to enable the modem.</li> <li>2. If the problem remains, replace the modem.</li> </ol> <p>If the problem remains, call for service.</p>
		Failed	Modem reset failed	<p>Replace the modem.</p> <p>If the problem remains, call for service.</p>
			No dial tone detected	<ol style="list-style-type: none"> <li>1. Make sure that the phone line attached to the modem has a dial tone. (Connect a phone to the line and listen, if necessary.) If there is no tone, have the phone line serviced.</li> <li>2. If the problem remains, replace the modem.</li> </ol> <p>If the problem remains, call for service.</p>

## Recovering BIOS code

If the BIOS code has become damaged, such as from a power failure during a flash update, you can recover the BIOS using the boot block jumper and a BIOS flash diskette. The boot block jumper selects between normal BIOS mode and flash recovery mode. In the normal position, the jumper will be installed on pins 2 and 3. In the recovery position, the jumper will be installed on pins 1 and 2.

**Note:** You can obtain a BIOS flash diskette from one of the following sources:

- Use the ServerGuide program to make a BIOS flash diskette.
- Download files to make a BIOS flash diskette from the World Wide Web. Go to <http://www.ibm.com/pc/support/>, select IBM System Support, and then make the selections for your system.
- Contact your IBM service representative.

Complete the following steps to recover the BIOS code:

1. Turn off the server and peripheral devices and disconnect all external cables and power cords; then, remove the cover, see "Removing the cover" on page 37.
2. Locate jumper JROM1 on the system board.

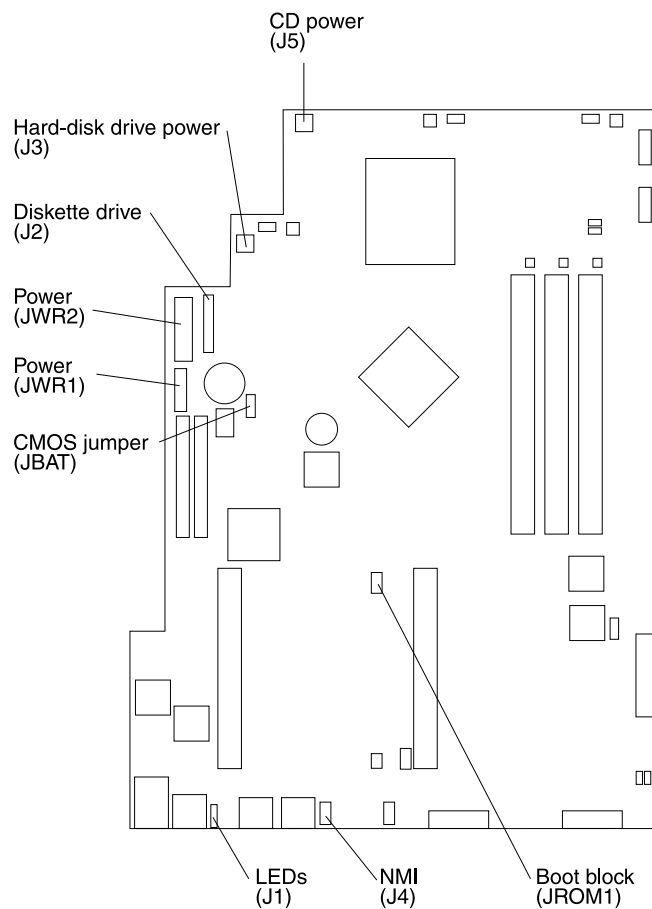

3. Move the JROM1 jumper to the alternate position (pins 1 and 2) to enable the BIOS recovery mode.
4. Reinstall the cover, see "Installing the cover" on page 46.
5. Reconnect all external cables and power cords and turn on the peripheral devices.

6. Insert the BIOS flash diskette in the diskette drive.
7. Restart the server. The BIOS begins the power-on self-test.
8. The BIOS flash utility automatically starts.
9. When prompted as to whether you want to save the current code to a diskette, type N.
10. When prompted, type Y to continue the flash process.
11. The system automatically starts the flash utility a second time.
12. When prompted as to whether you want to save the current BIOS code, stop the process by removing the BIOS flash diskette from the diskette drive.
13. Turn off the server and peripheral devices and disconnect all external cables and power cords; then, remove the cover, see “Removing the cover” on page 37.
14. Move the JROM1 jumper to the normal position (pins 2 and 3) to return to normal startup mode.
15. Reinstall the cover, see “Installing the cover” on page 46.
16. Reconnect all external cables and power cords and turn on the peripheral devices.
17. Restart the server, which should start up normally.

---

## Clearing CMOS

If you need to *erase* configuration information, you must move the CMOS jumper. See the illustration in “Recovering BIOS code” on page 78 for the location of the CMOS jumper.

The default position is a jumper installed on pins 1 and 2. Before you change the position of this jumper, you *must* turn off the server and peripheral devices, and disconnect all external cables and power cords. Remove the cover and then move the jumper to pins 2 and 3.

After moving the jumper, wait at least 5 minutes for the CMOS information to clear.

Changing the position of this jumper erases all configuration and setup information, including the power-on and administrator passwords. Therefore, you must reconfigure the server after clearing CMOS memory (see “Chapter 3. Configuring your server,” on page 13). If possible, record your server configuration information *before* moving the CMOS jumper.

After you clear the CMOS information, move the jumper back to its normal position (pins 1 and 2). Reconnect the external cables and power cords; then, turn on the peripheral devices and the server.

---

## Troubleshooting charts

You can use the troubleshooting charts in this section to find solutions to problems that have definite symptoms.

**Important:** If diagnostic error messages appear that are not listed in the following tables, make sure that your system has the latest levels of BIOS code installed.

See “Starting the diagnostic programs” on page 69 to test the system. If you have run the diagnostic test programs or if running the tests does not reveal the problem, call for service.

Look for the symptom in the left column of the chart. Instructions and probable solutions to the problem are in the right column. If you have just added new software

or a new option and your system is not working, do the following before using the troubleshooting charts:

- Remove the software or device that you just added.
- Run the diagnostic tests to determine if your system is running correctly.
- Reinstall the new software or new device.

Table 10. Troubleshooting charts.

Device	Suggested action
<b>CD-ROM drive</b>	Verify that:
CD-ROM drive is not recognized.	<ol style="list-style-type: none"> <li>1. The primary IDE channel is enabled in the Configuration/Setup Utility program.</li> <li>2. All cables and jumpers are installed correctly.</li> <li>3. The correct device driver is installed for the CD-ROM drive.</li> </ol>
<b>Diskette drive</b>	If there is a diskette in the drive, verify that:
Diskette drive in-use light stays on, or the system bypasses the diskette drive.	<ol style="list-style-type: none"> <li>1. The diskette drive is enabled in the Configuration/Setup Utility program.</li> <li>2. The diskette is good and not damaged. (Try another diskette if you have one.)</li> <li>3. The diskette contains the necessary files to start the system.</li> <li>4. Your software program is working properly.</li> </ol> <p>If the diskette drive in-use light stays on, or the system continues to bypass the diskette drive, call for service.</p>
<b>Expansion enclosure</b>	Verify that:
The SCSI expansion enclosure used to work, but does not work now.	<ol style="list-style-type: none"> <li>1. The cables for all external SCSI options are connected correctly.</li> <li>2. The last option in each SCSI chain, or the end of the SCSI cable, is terminated correctly.</li> <li>3. External SCSI options are turned on. You must turn on external SCSI options before turning on the system.</li> </ol> <p>For more information, see your SCSI and expansion enclosure documentation.</p>
<b>Other devices</b>	Call for service.
Problems such as broken cover locks or indicator lights not working.	
<b>Intermittent problems</b>	Verify that:
A problem occurs only occasionally and is difficult to detect.	<ol style="list-style-type: none"> <li>1. All cables and cords are connected securely to the rear of the system and attached options.</li> <li>2. When the system is turned on, air is flowing from the rear of the system at the fan grille. If there is no air flow, the fan is not working. This causes the system to overheat and shut down.</li> <li>3. Ensure that the SCSI bus and devices are configured correctly and that the last external device in each SCSI chain is terminated correctly.</li> </ol> <p>If the problem remains, call for service.</p>
<b>Keyboard, mouse, or pointing-device</b>	<ol style="list-style-type: none"> <li>1. Make sure that the keyboard cable is properly connected to the system.</li> <li>2. Make sure that the system and the monitor are turned on.</li> </ol>
All or some keys on the keyboard do not work.	<ol style="list-style-type: none"> <li>3. Try using another keyboard.</li> </ol> <p>If the problem remains, call for service.</p>

Table 10. Troubleshooting charts.

<b>Device</b>	<b>Suggested action</b>
The mouse or pointing device does not work.	<ol style="list-style-type: none"> <li>1. Verify that the mouse or pointing-device cable is securely connected and the device drivers are installed correctly.</li> <li>2. Try using another mouse or pointing device.</li> </ol> <p>If the problem remains, call for service.</p>
<b>Memory</b>	Verify that:
The amount of memory displayed is less than the amount of memory installed.	<ol style="list-style-type: none"> <li>1. The memory modules are seated properly.</li> <li>2. You have installed the correct type of memory.</li> <li>3. If you changed the memory, you must update the memory configuration with the Configuration/Setup Utility program.</li> <li>4. All banks of memory on the DIMMs are enabled. The system might have automatically disabled a DIMM bank if it detected a problem, or a DIMM bank could have been manually disabled.</li> </ol> <p>If the items above are correct and the screen remains blank, call for service.</p>
<b>Monitor</b>	Verify that:
The monitor works when you turn on the system, but goes blank when you start some application programs.	<ol style="list-style-type: none"> <li>1. The primary monitor cable is connected to the video port.</li> <li>2. You installed the necessary device drivers for the applications.</li> </ol> <p>Some IBM monitors have their own self-tests. If you suspect a problem with your monitor, refer to the information that comes with the monitor for adjusting and testing instructions.</p> <p>If you still cannot find the problem, call for service.</p>
The screen is blank.	<p>Verify that:</p> <ol style="list-style-type: none"> <li>1. The system power cord is plugged into the server and a working electrical outlet.</li> <li>2. The monitor cables are connected properly.</li> <li>3. The monitor is turned on and the brightness and contrast controls are adjusted correctly.</li> </ol> <p>If the items above are correct and the screen remains blank, call for service.</p>
Only the cursor appears.	Call for service.
Wavy, unreadable, rolling, distorted screen, or screen jitter.	<p>If the monitor self-tests show the monitor is working properly, consider the location of the monitor. Magnetic fields around other devices (such as transformers, appliances, fluorescent lights, and other monitors) can cause screen jitter or wavy, unreadable, rolling, or distorted screen images. If this happens, turn off the monitor. (Moving a color monitor while it is turned on might cause screen discoloration.) Then move the device and the monitor at least 305 mm (12 in.) apart. Turn on the monitor.</p> <p><b>Notes:</b></p> <ol style="list-style-type: none"> <li>1. To prevent diskette drive read/write errors, be sure the distance between monitors and diskette drives is at least 76 mm (3 in.).</li> <li>2. Non-IBM monitor cables might cause unpredictable problems.</li> <li>3. An enhanced monitor cable with additional shielding is available for the 9521 and 9527 monitors. For information about the enhanced monitor cable, see your IBM reseller or IBM marketing representative.</li> </ol> <p>If the problem remains, call for service.</p>

Table 10. Troubleshooting charts.

<b>Device</b>	<b>Suggested action</b>
Wrong characters appear on the screen.	<p>If the wrong language is displayed, update the BIOS code with the correct language.</p> <p>If the problem remains, call for service.</p>
<b>Option</b>	Verify that:
An IBM option that was just installed does not work.	<ol style="list-style-type: none"> <li>1. The option is designed for the server. Refer to the "Server Support" flowchart for information about obtaining ServerProven compatibility information from the World Wide Web.</li> <li>2. You followed the installation instructions that came with the option.</li> <li>3. The option is installed correctly.</li> <li>4. You have not loosened any other installed options or cables.</li> <li>5. You updated the configuration information in the Configuration/Setup Utility program. Whenever memory or an option is changed, you must update the configuration.</li> </ol> <p>If the problem remains, call for service.</p>
An IBM option that used to work does not work now.	<p>Verify that all of the option hardware and cable connections are secure.</p> <p>If the option comes with its own test instructions, use those instructions to test the option.</p> <p>If the failing option is a SCSI option, verify that:</p> <ol style="list-style-type: none"> <li>1. The cables for all external SCSI options are connected correctly.</li> <li>2. The last option in each SCSI chain, or the end of the SCSI cable, is terminated correctly.</li> <li>3. All external SCSI options are turned on. You must turn on external SCSI options before turning on the server.</li> </ol> <p>If the problem remains, call for service.</p>
<b>Power</b>	Verify that:
The system does not power on.	<ol style="list-style-type: none"> <li>1. The power cables are properly connected to the server.</li> <li>2. The electrical outlet functions properly.</li> <li>3. The type of memory installed is correct.</li> <li>4. If you just installed an option, remove it, and restart the server. If the server now turns on, you might have installed more options than the power supply supports.</li> <li>5. The LEDs on the power supply are on.</li> </ol> <p>If the problem remains, call for service.</p>
The system does not power off.	<p>Verify if you are using an ACPI or non-ACPI operating system.:</p> <p>If you are using a non-ACPI operating system:</p> <ol style="list-style-type: none"> <li>1. Press Ctrl+Alt+Delete.</li> <li>2. Turn off the system by using the power control button.</li> </ol> <p>If the problem remains or if you are using an ACPI aware operating system, call for service.</p>



Table 10. Troubleshooting charts.

Device	Suggested action
<b>Serial port</b>	Verify that:
The number of serial ports identified by the operating system is less than the number of serial ports installed.	<ol style="list-style-type: none"> <li>1. Each port is assigned a unique address by the Configuration/Setup Utility program and none of the serial ports are disabled.</li> <li>2. The serial-port adapter, if you installed one, is seated properly.</li> </ol> <p>If the problem still exists, call for service.</p>
A serial device does not work.	<p>Verify that:</p> <ol style="list-style-type: none"> <li>1. The device is compatible with the server.</li> <li>2. The serial port is enabled and is assigned a unique address.</li> </ol> <p>If the problem still exists, call for service.</p>
<b>Software</b>	To determine if problems are caused by the software, verify that:
Suspected software problem.	<ol style="list-style-type: none"> <li>1. Your system has the minimum memory requirements needed to use the software. For memory requirements, refer to the information that comes with the software. <b>Note:</b> If you have just installed an adapter or memory, you might have a memory address conflict.</li> <li>2. The software is designed to operate on your system.</li> <li>3. Other software works on your system.</li> <li>4. The software that you are trying to use works on another system.</li> </ol> <p>If you received any error messages when using the software program, refer to the information that comes with the software for a description of the messages and solutions to the problem.</p> <p>If the items above are correct and the problem remains, contact your place of purchase.</p>
<b>Universal Serial Bus (USB) ports</b>	Verify that:
A USB device does not work.	<ol style="list-style-type: none"> <li>1. You are not trying to use a USB device during POST, if you have a standard (non-USB) keyboard attached to the keyboard port. <b>Note:</b> If a standard (non-USB) keyboard is attached to the keyboard port, then the USB is disabled and the USB device might not work during POST.</li> <li>2. The correct USB device driver is installed.</li> <li>3. Your operating system supports USB devices.</li> </ol> <p>If the problem still exists, call for service.</p>

## Troubleshooting the Ethernet controller

This section provides troubleshooting information for problems that might occur with the 10/100 Mbps Ethernet controller.

### Network connection problems

If the Ethernet controller cannot connect to the network, check the following:

- Make sure that the cable is installed correctly.

The network cable must be securely attached at all connections. If the cable is attached but the problem persists, try a different cable.

If you set the Ethernet controller to operate at 100 Mbps, you must use Category 5 cabling.

If you directly connect two workstations (without a hub), or if you are not using a hub with X ports, use a crossover cable.

**Note:** To determine whether a hub has an X port, check the port label. If the label contains an X, the hub has an X port.

- Determine if the hub supports auto-negotiation. If not, try configuring the integrated Ethernet controller manually to match the speed and duplex mode of the hub.
- Check the LAN activity light (if available) on the rear of the server. The LAN activity light illuminates when the Ethernet controller sends or receives data over the Ethernet network. If the LAN activity light is off, make sure that the hub and network are operating and that the correct device drivers are loaded.
- Make sure that you are using the correct device drivers, supplied with your system.
- Check for operating system-specific causes for the problem.
- Make sure that the device drivers on the client and system are using the same protocol.
- Test the Ethernet controller.

The way you test the Ethernet controller depends on which operating system you are using (see the Ethernet controller device driver README file).

## Ethernet controller troubleshooting chart

You can use the following troubleshooting chart to find solutions to 10/100 Mbps Ethernet controller problems that have definable symptoms.

Table 11. Ethernet troubleshooting chart.

Ethernet controller problem	Suggested action
The server stops running when loading device drivers.	<p>The PCI BIOS interrupt settings are incorrect.</p> <p>Check the following:</p> <ul style="list-style-type: none"> <li>• Determine if the IRQ setting assigned to the Ethernet controller is also assigned to another device in the Configuration/Setup Utility program.</li> </ul> <p>Although interrupt sharing is allowed for PCI devices, some devices do not function well when they share an interrupt with a dissimilar PCI device. Try changing the IRQ assigned to the Ethernet controller or the other device. For example, for NetWare Versions 3 and 4 it is recommended that disk controllers not share interrupts with LAN controllers.</p> <ul style="list-style-type: none"> <li>• Make sure that you are using the most recent device driver available from the World Wide Web.</li> <li>• Run the network diagnostic program.</li> </ul> <p>If the problem remains, call for service.</p>
The LAN activity light does not light (when available).	<p>Check the following:</p> <ul style="list-style-type: none"> <li>• Make sure that you have loaded the network device drivers.</li> <li>• The network might be idle. Try sending data from this workstation.</li> <li>• Run diagnostics on the LEDs.</li> </ul>
Data is incorrect or sporadic.	<p>Check the following:</p> <ul style="list-style-type: none"> <li>• Make sure that you are using Category 5 cabling when operating the system at 100 Mbps.</li> <li>• Make sure that the cables do not run close to noise-inducing sources like fluorescent lights.</li> </ul>
The Ethernet controller stopped working when another adapter was added to the system.	<p>Check the following:</p> <ul style="list-style-type: none"> <li>• Make sure that the cable is connected to the Ethernet controller.</li> <li>• Make sure that your PCI system BIOS is current.</li> <li>• Reseat the adapter.</li> <li>• Determine if the IRQ setting assigned to the Ethernet adapter is also assigned to another device in the Configuration/Setup Utility program.</li> </ul> <p>Although interrupt sharing is allowed for PCI devices, some devices do not function well when they share an interrupt with a dissimilar PCI device. Try changing the IRQ assigned to the Ethernet adapter or the other device.</p> <p>If the problem remains, call for service.</p>
The Ethernet controller stopped working without apparent cause.	<p>Check the following:</p> <ul style="list-style-type: none"> <li>• Run diagnostics for the Ethernet controller.</li> <li>• Try a different connector on the hub.</li> <li>• Reinstall the device drivers. Refer to your operating system documentation and to the ServerGuide information.</li> </ul> <p>If the problem remains, call for service.</p>

## Ethernet controller messages

The integrated Ethernet controller might display messages from the following device drivers:

- Novell NetWare or IntraNetWare system open data-link interface (ODI)
- Network driver interface specification (NDIS) adapter for level 4.0 (Windows NT)

### Novell NetWare or IntraNetWare system ODI driver teaming messages

This section provides explanations of the error messages for the Novell NetWare or IntraNetWare system ODI driver, and suggested actions to resolve each problem.

Table 12. NetWare driver messages for the Ethernet controller.

Message	Description
Couldn't allocate resources.	<p><b>Explanation:</b> An unknown error has occurred when trying to allocate needed resources for the AFT Module.</p> <p><b>Action:</b></p> <ul style="list-style-type: none"> <li>• Check the system configuration. If the problem persists, contact your network supplier.</li> <li>• Verify that the Ethernet controller is enabled. If the Ethernet controller is enabled, run the diagnostic programs.</li> </ul>
AFT group for primary adapter in slot <i>nnn</i> already exists.	<p><b>Explanation:</b> An attempt was made to rebind an adapter already in an AFT group.</p> <p><b>Action:</b> Check the AFT slot numbers for existing AFT teams. If the problem persists, contact your network supplier.</p>
Error locating device control table (DCT) addresses in internal table. Make sure that you have loaded LAN drivers after loading AFT.NLM.	<p><b>Explanation:</b> The bind command was entered prior to loading the device driver. The device driver must be loaded after loading AFT.NLM, but before any bind command can be issued.</p> <p><b>Action:</b> Load the driver for the supported adapter and try loading the AFT module again. If the problem persists, contact your network supplier.</p>
Insufficient number of arguments specified.	<p><b>Explanation:</b> The appropriate or expected number of parameters was not entered in a command.</p> <p><b>Action:</b> Check the parameters required for the given command. If the problem persists, contact your network supplier.</p>
Duplicate slot numbers detected.	<p><b>Explanation:</b> An attempt has been made to bind the same slot number more than once.</p> <p><b>Action:</b> Check the slot numbers entered during the bind. Adapter slot numbers must be valid and unique. If the problem persists, contact your network supplier.</p>
'xxx' is not supported for AFT team.	<p><b>Explanation:</b> A bind command has been issued for adapters not supported by AFT.NLM.</p> <p><b>Action:</b> Make sure that you attempt to bind only adapters supported by AFT.NLM.</p>

Table 12. NetWare driver messages for the Ethernet controller.

Message	Description
Primary and Secondary adapters do not match. AFT group is not created.	<p><b>Explanation:</b> A bind command was entered for an adapter team that is a combination of system and client adapters. An AFT team must be a grouping of the same classification of adapter.</p> <p><b>Action:</b> Verify that all the adapters bound in a team are of the same classification.</p>
Requested number of Secondary cards are not found.	<p><b>Explanation:</b> The number of adapters specified in the bind command could not be located.</p> <p><b>Action:</b> Verify the numbers and slot locations of the adapters to be bound. If the problem persists, contact your network supplier.</p>
Failed to create AFT group. Make sure that the drivers for supported adapters are loaded, primary adapter is bound to protocols, and secondary adapter is not bound to any protocols.	<p><b>Explanation:</b> Binding of protocol failed. Protocol is either not bound to any adapter or is bound to more than one adapter in the group.</p> <p><b>Action:</b> Ensure that the protocol is bound to only one adapter in an AFT team.</p>
Error identifying slot numbers for the specified board names.	<p><b>Explanation:</b> The mapping between the board name entered and the slot number for an adapter could not be established.</p> <p><b>Action:</b> Check the board name for the adapter before issuing the bind command. If the problem persists, contact your network supplier.</p>
Can't unbind specified slot from AFT group. Make sure that the slot you specified is for the primary adapter in an AFT group.	<p><b>Explanation:</b> The number entered in the unbind command was not the primary adapter in an AFT group.</p> <p><b>Action:</b> Reissue the unbind command and specify the slot number for the primary adapter.</p>
LAN adapter at slot <i>nnnn</i> (Port 0xaa) failed to reset. Check the state of the adapter.	<p><b>Explanation:</b> The adapter that you specified could not be initialized.</p> <p><b>Action:</b></p> <ol style="list-style-type: none"> <li>1. Load the driver for the supported adapter.</li> <li>2. Check that the adapter is seated properly in the slot and try loading the AFT module again.</li> </ol> <p>If the problem persists, contact your network supplier.</p>
AFT is not supported on this version of NetWare.	<p><b>Explanation:</b> The NetWare on your system is not a version supported by AFT.</p> <p><b>Action:</b> Load and bind AFT only on supported versions of NetWare (currently version 4.11 and above).</p>
Failed to allocate resources tags.	<p><b>Explanation:</b> An unknown error has occurred when trying to allocate needed resources for the AFT module.</p> <p><b>Action:</b> Check system configuration. If the problem persists, contact your network supplier.</p>
Please unload all LAN drivers before unloading AFT.NLM.	<p><b>Explanation:</b> An attempt was made to unload the AFT.NLM module before unloading the adapter driver.</p> <p><b>Action:</b> Unload the adapter driver before unloading the AFT module.</p>

## NDIS 4.0 (Windows NT) driver messages

This section contains the error messages for the NDIS 4.0 drivers. The explanation and recommended action are included with each message.

Table 13. NDIS (Windows NT) driver messages for the Ethernet controller.

Error code (hex)	Description
0x00	<p><b>Explanation:</b> The driver could not register the specified interrupt.</p> <p><b>Action:</b> Using the Configuration/Setup Utility program, make sure that a PCI interrupt is assigned to your Ethernet card, and that Ethernet is enabled.</p>
0x01	<p><b>Explanation:</b> One of the PCI cards did not get the required resources.</p> <p><b>Action:</b> Using the Configuration/Setup Utility program, make sure that a PCI interrupt is assigned to your Ethernet card, and that Ethernet is enabled.</p>
0x02	<p><b>Explanation:</b> Bad node address (multicast address).</p> <p><b>Action:</b> Make sure the locally administered address is valid, if one is specified. The address cannot be a multicast address.</p>
0x03	<p><b>Explanation:</b> Failed self-test.</p> <p><b>Action:</b> Make sure a cable is attached to the Ethernet connector. If the problem remains, call for service.</p>
0x0D	<p><b>Explanation:</b> Could not allocate enough memory for transmit queues.</p> <p><b>Action:</b></p> <ol style="list-style-type: none"> <li>1. From the Windows NT desktop, select <b>Start</b> → <b>Control Panel</b> → <b>Networks</b> → <b>Adapters</b>.</li> <li>2. Select your IBM Ethernet adapter from the list.</li> <li>3. Select <b>Properties</b> → <b>Advanced</b>.</li> <li>4. Lower the resource values that apply to the transmit queue.</li> </ol>
0x0E	<p><b>Explanation:</b> Could not allocate enough memory for receive queue.</p> <p><b>Action:</b></p> <ol style="list-style-type: none"> <li>1. From the Windows NT desktop, select <b>Start</b> → <b>Control Panel</b> → <b>Networks</b> → <b>Adapters</b>.</li> <li>2. Select your IBM Ethernet adapter from the list.</li> <li>3. Select <b>Properties</b> → <b>Advanced</b>.</li> <li>4. Lower the resource values that apply to the receive queue.</li> </ol>
0x0F	<p><b>Explanation:</b> Could not allocate enough memory for other structures. <b>Action:</b></p> <ol style="list-style-type: none"> <li>1. From the Windows NT desktop, select <b>Start</b> → <b>Control Panel</b> → <b>Networks</b> → <b>Adapters</b>.</li> <li>2. Select your IBM Ethernet adapter from the list.</li> <li>3. Select <b>Properties</b> → <b>Advanced</b>.</li> <li>4. Lower the value for the resource named in the message.</li> </ol>
0x10	<p><b>Explanation:</b> Did not find any Ethernet controllers.</p> <p><b>Action:</b> Using the Configuration/Setup Utility program, make sure that Ethernet is enabled.</p>
0x11	<p><b>Explanation:</b> Multiple Ethernet controllers found, but none matched the required ID.</p> <p><b>Action:</b> Using the Configuration/Setup Utility program, make sure that Ethernet is enabled.</p>
0x13	<p><b>Explanation:</b> Did not find any Ethernet controllers that matched the required subven/subdev. <b>Action:</b> Using the Configuration/Setup Utility program, make sure that Ethernet is enabled.</p>

Table 13. NDIS (Windows NT) driver messages for the Ethernet controller.

Error code (hex)	Description
0x16	<p><b>Explanation:</b> Single adapter found, but multiple instances tried to load.</p> <p><b>Action:</b> Using the Configuration/Setup Utility program, make sure that Ethernet is enabled, and that the slot containing the IBM xSeries 300 10/100 Ethernet Adapter or the IBM 10/100 EtherJet PCI adapter is enabled.</p>
0x17	<p><b>Explanation:</b> Slot parameter not specified in the registry.</p> <p><b>Action:</b> Remove the adapter driver and reinstall it. If the problem remains, call for service.</p>
All other 4-character hexadecimal codes	<p><b>Action:</b> Call for service.</p>

## Ethernet teaming messages

This section displays the messages associated with Ethernet teaming.

Table 14. NDIS (Windows NT) driver teaming messages for the Ethernet controller.

Event ID	Type	Description
01	Error	<b>Explanation:</b> Team name and physical adapter name are the same. This is an invalid configuration. <b>Action:</b> Reconfigure the adapter team by double-clicking the <b>PROSet</b> icon in the control panel.
02	Error	<b>Explanation:</b> Unable to allocate required resources. <b>Action:</b> Free some memory resources and restart.
03	Error	<b>Explanation:</b> Unable to read required registry parameters. <b>Action:</b> Reconfigure the adapter team by double-clicking the <b>PROSet</b> icon in the control panel.
04	Error	<b>Explanation:</b> Unable to bind to physical adapter. <b>Action:</b> Reconfigure the adapter team by double-clicking the <b>PROSet</b> icon in the control panel.
05	Error	<b>Explanation:</b> Unable to initialize an adapter team <b>Action:</b> Reconfigure the adapter team by double-clicking the <b>PROSet</b> icon in the control panel.
06	Informational	<b>Explanation:</b> Team <i>nn</i> . Primary adapter is initialized. <b>Action:</b> None.
07	Informational	<b>Explanation:</b> Team <i>nn</i> . Secondary adapter is initialized. <b>Action:</b> None.
08	Informational	<b>Explanation:</b> Team <i>nn</i> . Virtual adapter or Team is initialized. <b>Action:</b> None.
09	Informational	<b>Explanation:</b> Team <i>nn</i> . Primary adapter is switching over. <b>Action:</b> None.
10	Warning	<b>Explanation:</b> Team <i>nn</i> . Adapter link down. <b>Action:</b> Make sure the adapter is functioning properly.
11	Informational	<b>Explanation:</b> Team <i>nn</i> . Secondary adapter took over. <b>Action:</b> None.
12	Warning	<b>Explanation:</b> Team <i>nn</i> . Secondary adapter is deactivated from the Team. <b>Action:</b> Make sure the secondary adapter is functioning properly and that the adapter cable is securely connected to the LAN.
13	Informational	<b>Explanation:</b> Team <i>nn</i> . Secondary adapter has rejoined the Team. <b>Action:</b> None.



Table 14. NDIS (Windows NT) driver teaming messages for the Ethernet controller.

Event ID	Type	Description
14	Informational	<b>Explanation:</b> Team <i>nn</i> . Secondary adapter link is up. <b>Action:</b> None.
15	Error	<b>Explanation:</b> Team <i>nn</i> . The last adapter has lost its link. Network connection has been lost. <b>Action:</b> Shut down the server and replace the adapters; then, restart the server to reestablish the connection.
16	Informational	<b>Explanation:</b> Team <i>nn</i> . An adapter has reestablished the link. Network connection has been restored. <b>Action:</b> None.
17	Informational	<b>Explanation:</b> Team <i>nn</i> . Preferred primary adapter has been detected. <b>Action:</b> None.
18	Informational	<b>Explanation:</b> Team <i>nn</i> . Preferred secondary adapter has been detected. <b>Action:</b> None.
19	Informational	<b>Explanation:</b> Team <i>nn</i> . Preferred primary adapter took over. <b>Action:</b> None.
20	Informational	<b>Explanation:</b> Team <i>nn</i> . Preferred secondary adapter took over. <b>Action:</b> None.
21	Warning	<b>Explanation:</b> Team <i>nn</i> . Primary adapter does not sense any probes. Possible reason: partitioned Team. <b>Action:</b> Make sure the cables of the adapter team are connected to the same LAN segment. Reconfigure the team if necessary.

---

## Replacing the battery

When replacing the battery, you must replace it with a lithium battery of the same type from the same manufacturer. To avoid possible danger, read and follow the safety statement below.

To order replacement batteries, call 1-800-772-2227 within the United States, and 1-800-465-7999 or 1-800-465-6666 within Canada. Outside the U.S. and Canada, call your IBM reseller or IBM marketing representative.

**Note:** After you replace the battery, you must reconfigure your system and reset the system date and time.

### Statement 2

#### CAUTION:



**When replacing the lithium battery, use only IBM Part Number 33F8354 or an equivalent type battery recommended by the manufacturer. If your system has a module containing a lithium battery, replace it only with the same module type made by the same manufacturer. The battery contains lithium and can explode if not properly used, handled, or disposed of.**

#### Do not:

- **Throw or immerse into water.**
- **Heat to more than 100 C (212 F)**
- **Repair or disassemble**

**Dispose of the battery as required by local ordinances or regulations.**

Complete the following steps to replace the battery.

1. Read “Before you begin” on page 29, and follow any special handling and installation instructions supplied with the replacement battery.
2. Turn off the server and peripheral devices and disconnect all external cables and power cords.
3. Remove the cover. See “Removing the cover” on page 37.
4. Remove the battery:
  - a. Press the battery release tab to release the battery from the socket.
  - b. Lift the battery out of the socket.

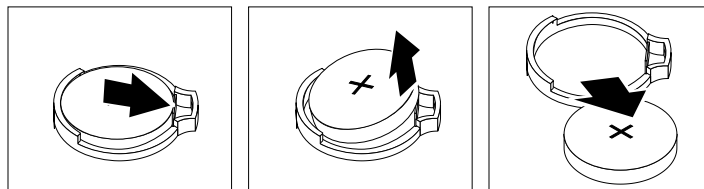

5. Insert the new battery:
  - a. Tilt the battery so that you can insert it into the socket.

- b. Press down on the battery after you insert it into the socket.

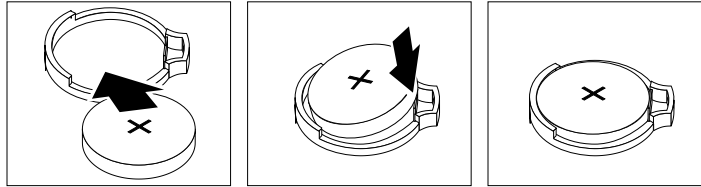

6. Reinstall the server cover, see "Installing the cover" on page 46.
7. Reconnect the external cables and power cords; then, turn on the peripheral devices and the server.
8. Start the Configuration/Setup Utility program and set configuration parameters.
  - Set the system date and time.
  - Set the power-on password.
  - Reconfigure your server.

## Getting help, service, and information

If you need help, service, technical assistance, or just want more information about IBM products, you will find a wide variety of sources available from IBM to assist you.

For example, IBM maintains pages on the World Wide Web where you can get information about IBM products and services, find the latest technical information, and download device drivers and updates. Some of these pages are:

<a href="http://www.ibm.com">http://www.ibm.com</a>	Main IBM home page
<a href="http://www.ibm.com/pc">http://www.ibm.com/pc</a>	IBM Personal Computing
<a href="http://www.ibm.com/pc/support">http://www.ibm.com/pc/support</a>	IBM Personal Computing Support
<a href="http://www.ibm.com/pc/us/ibmpc">http://www.ibm.com/pc/us/ibmpc</a>	IBM Commercial Desktop PCs (U.S.)
<a href="http://www.ibm.com/pc/us/intellistation">http://www.ibm.com/pc/us/intellistation</a>	IBM IntelliStation® Workstations (U.S.)
<a href="http://www.ibm.com/pc/us/accessories">http://www.ibm.com/pc/us/accessories</a>	Options by IBM (U.S.)
<a href="http://www.ibm.com/pc/us/eserver/xseries">http://www.ibm.com/pc/us/eserver/xseries</a>	IBM xSeries systems (U.S.)
<a href="http://www.ibm.com/pc/us/system/sguide">http://www.ibm.com/pc/us/system/sguide</a>	IBM ServerGuide (U.S.)
<a href="http://www.ibm.com/software/os/warp-system">http://www.ibm.com/software/os/warp-system</a>	IBM OS/2 WARP® system
<a href="http://www.ibm.com/pc/techconnect">http://www.ibm.com/pc/techconnect</a>	IBM TechConnect®

You can select a country-specific Web site from these pages.

You might also want to visit the Web pages of other companies for information about other operating systems, software, and accessories. The following are some other Web sites you might find helpful:

<http://www.lotus.com>    <http://www.tivoli.com>    <http://www.microsoft.com>  
<http://www.novell.com>    <http://www.sco.com>    <http://www.adaptec.com>  
<http://www.apcc.com>    <http://www.norton.com>

Help is also available from on-line services, as well as by fax and telephone. This section provides information about these sources.

Services available and telephone numbers listed are subject to change without notice.

## Service support

With the original purchase of an IBM hardware product, you have access to extensive support coverage. During the IBM hardware product warranty period, you may call the IBM Personal Computer (1-800-772-2227 in the U.S.) for hardware product assistance covered under the terms of the IBM hardware warranty. See “Getting help by telephone” on page 96 for HelpCenter telephone numbers in other countries.

The following services are available during the warranty period:

- Problem determination - Trained personnel are available to assist you with determining if you have a hardware problem and deciding what action is necessary to fix the problem.
- IBM hardware repair - If the problem is determined to be caused by IBM hardware under warranty, trained service personnel are available to provide the applicable level of service.
- Engineering change management - Occasionally, there might be changes that are required after a product has been sold. IBM or your reseller, if authorized by IBM, will make engineering changes (ECs) available that apply to your hardware.

Be sure to retain your proof of purchase to obtain warranty service.

Please have the following information ready when you call:

- Machine type and model
- Serial numbers of your IBM hardware products
- Description of the problem
- Exact wording of any error messages
- Hardware and software configuration information

If possible, be at your computer when you call.

A compatible monitor, keyboard, and mouse are required for many service activities. Before you have the computer serviced, be sure to have these components attached to your computer, either directly or through a console switch.

The following items are not covered:

- Replacement or use of non-IBM parts or non warranted IBM parts  
**Note:** All warranted parts contain a 7-character identification in the format IBM FRU XXXXXXX.
- Identification of software problem sources
- Configuration of BIOS as part of an installation or upgrade
- Changes, modifications, or upgrades to device drivers
- Installation and maintenance of network operating systems
- Installation and maintenance of application programs

Refer to your IBM hardware warranty for a full explanation of IBM's warranty terms.

## Before you call for service

Many computer problems can be solved without outside assistance, by using the online help or by looking in the online or printed documentation that comes with your computer or software. Also, be sure to read the information in any README files that come with your software.

Most computers, operating systems, and application programs come with documentation that contains troubleshooting procedures and explanations of error messages. The documentation that comes with your computer also contains information about the diagnostic tests you can perform.

If you suspect a software problem, consult the documentation (including README files) for the operating system or application program.

## Getting customer support and service

Purchasing an IBM PC hardware product entitles you to standard help and support during the warranty period. If you need additional support and services, a wide variety of extended services are available for purchase that address almost any need.

### Using the World Wide Web

On the World Wide Web, the IBM Personal Computing Web site has up-to-date information about IBM Personal Computer products and support. The address for the IBM Personal Computing home page is <http://www.ibm.com/pc>

You can find support information for your IBM products, including supported options, on the IBM Personal Computing Support page at <http://www.ibm.com/pc/support>

If you select Profile from the support page, you can create a customized support page that is specific to your hardware, complete with frequently asked questions, parts information, technical hints and tips, and downloadable files. You will have the information you need, all in one place. In addition, you can choose to receive e-mail notifications whenever new information becomes available about your registered products. You also can access online support forums, which are community sites monitored by IBM's support staff.

For information about specific Personal Computer products, visit the following pages:

<http://www.ibm.com/pc/us/ibmpc>                      <http://www.ibm.com/pc/us/intellistation>  
<http://www.ibm.com/pc/us/eserver/xseries>      <http://www.ibm.com/pc/us/thinkpad>  
<http://www.ibm.com/pc/us/accessories>  
[http://www.direct.ibm.com/content/home/en\\_US/aptiva](http://www.direct.ibm.com/content/home/en_US/aptiva)

You can select a country-specific Web site from these pages.

### Using electronic support services

If you have a modem, you can get help from several popular services. Online information services provide assistance through question-and-answer message areas, live chat rooms, searchable databases, and more.

Technical information is available on a wide range of topics, such as:

- Hardware setup and configuration
- Preinstalled software
- Windows, OS/2, and DOS
- Networking
- Communications
- Multimedia

In addition, the latest device driver updates are available.

Commercial online services, such as America Online (AOL), contain information about IBM products. (For AOL, use the keyword **IBM**.)

### Getting information by fax

If you have a touch-tone telephone and access to a fax machine in the U.S. and Canada you can receive by fax marketing and technical information on many topics, including hardware, operating systems, and local area networks. You can call the IBM

Automated Fax System 24 hours a day, 7 days a week. Follow the recorded instructions, and the requested information will be sent to your fax machine.

In the U.S. and Canada, to access the IBM Automated Fax System, call 1-800-426-3395.

## Getting help online

Online Housecall is a remote communication tool that enables an IBM technical-support representative to access your PC by modem. Many problems can be remotely diagnosed and corrected quickly and easily. In addition to a modem, a remote-access application program is required. This service is not available for systems. There might be a charge for this service, depending on the request.

For more information about configuring your PC for Online Housecall:

- In the U.S., call 1-800-772-2227.
- In Canada, call 1-800-565-3344.
- In all other countries, contact your IBM reseller or IBM marketing representative.

## Getting help by telephone

During the warranty period, you can get help and information by telephone through the IBM PC HelpCenter. Expert technical-support representatives are available to assist you with questions you might have on the following:

- Setting up your computer and IBM monitor
- Installing and setting up IBM options purchased from IBM or an IBM reseller
- 30-day, preinstalled-operating-system support
- Arranging for service (on-site or carry-in)
- Arranging for overnight shipment of customer-replaceable parts

In addition, if you purchased an IBM xSeries system, you are eligible for IBM Start Up Support for 90 days after installation. This service provides assistance for:

- Setting up your network operating system
- Installing and configuring interface cards
- Installing and configuring network adapters

Please have the following information ready when you call:

- Machine type and model
- Serial numbers of your computer, monitor, and other components, or your proof of purchase
- Description of the problem
- Exact wording of any error messages
- Hardware and software configuration information for your system

If possible, be at your computer when you call.

In the U.S. and Canada, these services are available 24 hours a day, 7 days a week. In the U.K., these services are available Monday through Friday, from 9:00 a.m. to 6:00 p.m.<sup>1</sup>

---

1. Response time will vary depending on the number and complexity of incoming calls.

Country		Number
Austria	Österreich	1-546 585 075
Belgium - Dutch	Belgie	02-717-2504
Belgium - French	Belgique	02-717-2503
Canada	Canada	1-800-565-3344
Denmark	Danmark	03-525-6905
Finland	Suomi	9-22-931805
France	France	01-69-32-40-03
Germany	Deutschland	069-6654-9003
Ireland	Ireland	01-815-9207
Italy	Italia	02-4827-5003
Luxembourg	Luxembourg	298-977-5060
Netherlands	Nederland	020-504-0531
Norway	Norge	2-305-3203
Portugal	Portugal	01-791-5147
Spain	España	091-662-4270
Sweden	Sverige	08-632-0063
Switzerland - German	Schweiz	01-212-1810
Switzerland - French	Suisse	022-310-0418
Switzerland - Italian	Svizzera	091-971-0523
United Kingdom	United Kingdom	01475-555555
U.S.A. and Puerto Rico	U.S.A. and Puerto Rico	1-800-772-2227

In all other countries, contact your IBM reseller or IBM marketing representative.

## Getting help around the world

If you travel with your computer or need to move it to another country, you can register for International Warranty Service. When you register with the International Warranty Service Office, you will receive an International Warranty Service Certificate that is honored virtually worldwide, wherever IBM or IBM resellers sell and service IBM PC products.

For more information or to register for International Warranty Service:

- In the U.S. or Canada, call 1-800-497-7426.
- In Europe, call 44-1475-893638 (Greenock, U.K.).
- In Australia and New Zealand, call 61-2-9354-4171.

In all other countries, contact your IBM reseller or IBM marketing representative.

## Purchasing additional services

During and after the warranty period, you can purchase additional services, such as support for IBM and non-IBM hardware, operating systems, and application programs; network setup and configuration; upgraded or extended hardware repair services; and custom installations. Service availability and name might vary by country.

## Enhanced PC support line

Enhanced PC Support is available for desktop and mobile IBM computers that are not connected to a network. Technical support is provided for IBM computers and IBM or non-IBM options, operating systems, and application programs on the Supported Products list.

This service includes technical support for:

- Installing and configuring your out-of-warranty IBM computer
- Installing and configuring non-IBM options in IBM computers
- Using IBM operating systems in IBM and non-IBM computers
- Using application programs and games
- Tuning performance
- Installing device drivers remotely
- Setting up and using multimedia devices
- Identifying system problems
- Interpreting documentation

You can purchase this service on a per-call basis, as a multiple-incident package, or as an annual contract with a 10-incident limit. For more information about purchasing Enhanced PC Support, see “Ordering support line services”.

## 900-number operating system and hardware support line

In the U.S., if you prefer to obtain technical support on a pay-as-you-go basis, you can use the 900-number support line. The 900-number support line provides support for IBM PC products that are out of the warranty period.

To access this support, call 1-900-555-CLUB (2582). You will be notified of the charge per minute.

## Network and system support line

Network and system Support is available for simple or complex networks made up of IBM systems and workstations using major network operating systems. In addition, many popular non-IBM adapters and network interface cards are supported.

This service includes all of the features of the Enhanced PC Support Line, plus:

- Installing and configuring client workstations and systems
- Identifying system problems and correcting problems on the client or the system
- Using IBM and non-IBM network operating systems
- Interpreting documentation

You can purchase this service on a per-call basis, as a multiple-incident package, or as an annual contract with a 10-incident limit. For more information about purchasing Network and system Support, see “Ordering support line services”.

## Ordering support line services

Enhanced PC Support Line and Network and system Support Line services are available for products on the Supported Products list. To receive a Supported Products list:

- In the U.S.:
  1. Call 1-800-426-3395.
  2. Select document number 11683 for Network and system support.
  3. Select document number 11682 for Enhanced PC support.
- In Canada, contact IBM Direct at 1-800-465-7999, or:



1. Call 1-800-465-3299.
  2. Select the HelpWare catalog.
- In all other countries, contact your IBM reseller or IBM marketing representative.

For more information or to purchase these services:

- In the U.S., call 1-800-772-2227.
- In Canada, call 1-800-465-7999.
- In all other countries, contact your HelpCenter.

## **Warranty and repair services**

You can upgrade your standard hardware warranty service or extend the service beyond the warranty period.

Warranty upgrades in the U.S. include:

- Carry-in service to on-site service  
If your warranty provides carry-in repair service, you can upgrade to on-site repair service, either standard or premium. The standard upgrade provides a trained service technician within the next business day (9 a.m. to 5 p.m., local time, Monday through Friday). The premium upgrade provides 4-hour average response, 24 hours a day, 7 days a week.
- On-site service to premium on-site service  
If your warranty provides for on-site service, you can upgrade to premium on-site service (4-hour average on-site response, 24 hours a day, 7 days a week).

You also can extend your warranty. Warranty and Repair Services offers a variety of post-warranty maintenance options, including ThinkPad EasyServ Maintenance Agreements. Availability of the services varies by product.

For more information about warranty upgrades and extensions:

- In the U.S., call 1-800-426-4968.
- In Canada, call 1-800-465-7999.
- In all other countries, contact your IBM reseller or IBM marketing representative.

## **Ordering publications**

Additional publications are available for purchase from IBM. For a list of publications available in your country:

- In the U.S., Canada, and Puerto Rico, call 1-800-879-2755.
- In other countries, contact your IBM reseller or IBM marketing representative.



---

## Appendix A. Product warranties and notices

This chapter contains warranty and emission notices. It also contains trademarks and general-information notices.

---

### Warranty Information

This section contains the warranty period for your product and the IBM Statement of Limited Warranty.

#### Warranty Period

The warranty period varies by country or region.

##### Notes:

- Contact your place of purchase for warranty service information. Some IBM Machines are eligible for on-site warranty service depending on the country or region where service is performed.
- A warranty period of 3 years on parts and 1 year on labor means that IBM will provide warranty service without charge for:
  1. parts and labor during the first year of the warranty period
  2. parts only, on an exchange basis, in the second and third years of the warranty period.

IBM will charge you for any labor it provides in performance of the repair or replacement.

**Machine:** IBM @server xSeries 300

Country or region	Warranty period
United States, Canada, and Japan	Parts - 3 years, labor - 1 year
All other countries	Parts - 3 years, labor - 3 years

#### IBM Statement of Limited Warranty

Z125-4753-06 8/2000

##### Part 1 - General Terms

This Statement of Limited Warranty includes Part 1 - General Terms and Part 2 - Country-unique Terms. The terms of Part 2 replace or modify those of Part 1. The warranties provided by IBM in this Statement of Limited Warranty apply only to Machines you purchase for your use, and not for resale, from IBM or your reseller. The term "Machine" means an IBM machine, its features, conversions, upgrades, elements, or accessories, or any combination of them. The term "Machine" does not include any software programs, whether pre-loaded with the Machine, installed subsequently or otherwise. Unless IBM specifies otherwise, the following warranties apply only in the country where you acquire the Machine. Nothing in this Statement of Limited Warranty affects any statutory rights of consumers that cannot be waived or limited by contract. If you have any questions, contact IBM or your reseller.

## The IBM Warranty for Machines

IBM warrants that each Machine 1) is free from defects in materials and workmanship and 2) conforms to IBM's Official Published Specifications ("Specifications"). The warranty period for a Machine is a specified, fixed period commencing on its Date of Installation. The date on your sales receipt is the Date of Installation unless IBM or your reseller informs you otherwise.

If a Machine does not function as warranted during the warranty period, and IBM or your reseller are unable to either 1) make it do so or 2) replace it with one that is at least functionally equivalent, you may return it to your place of purchase and your money will be refunded.

### Extent of Warranty

The warranty does not cover the repair or exchange of a Machine resulting from misuse, accident, modification, unsuitable physical or operating environment, improper maintenance by you, or failure caused by a product for which IBM is not responsible. The warranty is voided by removal or alteration of Machine or parts identification labels.

**THESE WARRANTIES ARE YOUR EXCLUSIVE WARRANTIES AND REPLACE ALL OTHER WARRANTIES OR CONDITIONS, EXPRESS OR IMPLIED, INCLUDING, BUT NOT LIMITED TO, THE IMPLIED WARRANTIES OR CONDITIONS OF MERCHANTABILITY AND FITNESS FOR A PARTICULAR PURPOSE. THESE WARRANTIES GIVE YOU SPECIFIC LEGAL RIGHTS AND YOU MAY ALSO HAVE OTHER RIGHTS WHICH VARY FROM JURISDICTION TO JURISDICTION. SOME JURISDICTIONS DO NOT ALLOW THE EXCLUSION OR LIMITATION OF EXPRESS OR IMPLIED WARRANTIES, SO THE ABOVE EXCLUSION OR LIMITATION MAY NOT APPLY TO YOU. IN THAT EVENT, SUCH WARRANTIES ARE LIMITED IN DURATION TO THE WARRANTY PERIOD. NO WARRANTIES APPLY AFTER THAT PERIOD.**

### Items Not Covered by Warranty

IBM does not warrant uninterrupted or error-free operation of a Machine.

Any technical or other support provided for a Machine under warranty, such as assistance via telephone with "how-to" questions and those regarding Machine set-up and installation, will be provided **WITHOUT WARRANTIES OF ANY KIND**.

### Warranty Service

To obtain warranty service for a Machine, contact IBM or your reseller. If you do not register your Machine with IBM, you may be required to present proof of purchase.

During the warranty period, IBM or your reseller, if approved by IBM to provide warranty service, provides without charge certain types of repair and exchange service to keep Machines in, or restore them to, conformance with their Specifications. IBM or your reseller will inform you of the available types of service for a Machine based on its country of installation. At its discretion, IBM or your reseller will 1) either repair or exchange the failing Machine and 2) provide the service either at your location or a service center. IBM or your reseller will also manage and install selected engineering changes that apply to the Machine.

Some parts of IBM Machines are designated as Customer Replaceable Units (called "CRUs"), e.g., keyboards, memory, or hard disk drives. IBM ships CRUs to you for replacement by you. You must return all defective CRUs to IBM within 30 days of your receipt of the replacement CRU. You are responsible for downloading designated Machine Code and Licensed Internal Code updates from an IBM Internet Web site or from other electronic media, and following the instructions that IBM provides.

When warranty service involves the exchange of a Machine or part, the item IBM or your reseller replaces becomes its property and the replacement becomes yours. You represent that all removed items are genuine and unaltered. The replacement may not be new, but will be in good working order and at least functionally equivalent to the item replaced. The replacement assumes the warranty service status of the replaced item. Many features, conversions, or upgrades involve the removal of parts and their return to IBM. A part that replaces a removed part will assume the warranty service status of the removed part.

Before IBM or your reseller exchanges a Machine or part, you agree to remove all features, parts, options, alterations, and attachments not under warranty service.

You also agree to

1. ensure that the Machine is free of any legal obligations or restrictions that prevent its exchange;
2. obtain authorization from the owner to have IBM or your reseller service a Machine that you do not own; and
3. where applicable, before service is provided:
  - a. follow the problem determination, problem analysis, and service request procedures that IBM or your reseller provides;
  - b. secure all programs, data, and funds contained in a Machine;
  - c. provide IBM or your reseller with sufficient, free, and safe access to your facilities to permit them to fulfill their obligations; and
  - d. inform IBM or your reseller of changes in a Machine's location.

IBM is responsible for loss of, or damage to, your Machine while it is 1) in IBM's possession or 2) in transit in those cases where IBM is responsible for the transportation charges.

Neither IBM nor your reseller is responsible for any of your confidential, proprietary or personal information contained in a Machine which you return to IBM or your reseller for any reason. You should remove all such information from the Machine prior to its return.

### **Limitation of Liability**

Circumstances may arise where, because of a default on IBM's part or other liability, you are entitled to recover damages from IBM. In each such instance, regardless of the basis on which you are entitled to claim damages from IBM (including fundamental breach, negligence, misrepresentation, or other contract or tort claim), except for any liability that cannot be waived or limited by applicable laws, IBM is liable for no more than

1. damages for bodily injury (including death) and damage to real property and tangible personal property; and
2. the amount of any other actual direct damages, up to the charges (if recurring, 12 months' charges apply) for the Machine that is subject of the claim. For purposes of this item, the term "Machine" includes Machine Code and Licensed Internal Code.

This limit also applies to IBM's suppliers and your reseller. It is the maximum for which IBM, its suppliers, and your reseller are collectively responsible.

**UNDER NO CIRCUMSTANCES IS IBM LIABLE FOR ANY OF THE FOLLOWING: 1) THIRD-PARTY CLAIMS AGAINST YOU FOR DAMAGES (OTHER THAN THOSE UNDER THE FIRST ITEM LISTED ABOVE); 2) LOSS OF, OR DAMAGE TO, YOUR RECORDS OR DATA; OR 3) SPECIAL, INCIDENTAL, OR INDIRECT DAMAGES OR FOR ANY ECONOMIC CONSEQUENTIAL DAMAGES, LOST PROFITS OR LOST SAVINGS, EVEN IF IBM, ITS SUPPLIERS OR YOUR RESELLER IS INFORMED OF THEIR POSSIBILITY. SOME JURISDICTIONS DO NOT ALLOW**

**THE EXCLUSION OR LIMITATION OF INCIDENTAL OR CONSEQUENTIAL DAMAGES, SO THE ABOVE LIMITATION OR EXCLUSION MAY NOT APPLY TO YOU.**

**Governing Law**

Both you and IBM consent to the application of the laws of the country in which you acquired the Machine to govern, interpret, and enforce all of your and IBM's rights, duties, and obligations arising from, or relating in any manner to, the subject matter of this Agreement, without regard to conflict of law principles.

**Part 2 - Country-unique Terms**

**AMERICAS**

**BRAZIL**

**Governing Law:** *The following is added after the first sentence:*

Any litigation arising from this Agreement will be settled exclusively by the court of Rio de Janeiro.

**NORTH AMERICA**

**Warranty Service:** *The following is added to this Section:*

To obtain warranty service from IBM in Canada or the United States, call 1-800-IBM-SERV (426-7378).

**CANADA**

**Governing Law:** *The following replaces "laws of the country in which you acquired the Machine" in the first sentence:*

laws in the Province of Ontario.

**UNITED STATES**

**Governing Law:** *The following replaces "laws of the country in which you acquired the Machine" in the first sentence:*

laws of the State of New York.

**ASIA PACIFIC**

**AUSTRALIA**

**The IBM Warranty for Machines:** *The following paragraph is added to this Section:*

The warranties specified in this Section are in addition to any rights you may have under the Trade Practices Act 1974 or other similar legislation and are only limited to the extent permitted by the applicable legislation.

**Limitation of Liability:** *The following is added to this Section:*

Where IBM is in breach of a condition or warranty implied by the Trade Practices Act 1974 or other similar legislation, IBM's liability is limited to the repair or replacement of the goods or the supply of equivalent goods. Where that condition or warranty relates to right to sell, quiet possession or clear title, or the goods are of a kind ordinarily acquired for personal, domestic or household use or consumption, then none of the limitations in this paragraph apply.

**Governing Law:** *The following replaces "laws of the country in which you acquired the Machine" in the first sentence:*

laws of the State or Territory.

**CAMBODIA, LAOS, AND VIETNAM**

**Governing Law:** *The following replaces "laws of the country in which you acquired the Machine" in the first sentence:*  
laws of the State of New York.

*The following is added to this Section:*

Disputes and differences arising out of or in connection with this Agreement shall be finally settled by arbitration which shall be held in Singapore in accordance with the rules of the International Chamber of Commerce (ICC). The arbitrator or arbitrators designated in conformity with those rules shall have the power to rule on their own competence and on the validity of the Agreement to submit to arbitration. The arbitration award shall be final and binding for the parties without appeal and the arbitral award shall be in writing and set forth the findings of fact and the conclusions of law.

All proceedings shall be conducted, including all documents presented in such proceedings, in the English language. The number of arbitrators shall be three, with each side to the dispute being entitled to appoint one arbitrator.

The two arbitrators appointed by the parties shall appoint a third arbitrator before proceeding upon the reference. The third arbitrator shall act as chairman of the proceedings. Vacancies in the post of chairman shall be filled by the president of the ICC. Other vacancies shall be filled by the respective nominating party. Proceedings shall continue from the stage they were at when the vacancy occurred.

If one of the parties refuses or otherwise fails to appoint an arbitrator within 30 days of the date the other party appoints its, the first appointed arbitrator shall be the sole arbitrator, provided that the arbitrator was validly and properly appointed.

The English language version of this Agreement prevails over any other language version.

## **HONG KONG AND MACAU**

**Governing Law:** *The following replaces "laws of the country in which you acquired the Machine" in the first sentence:*  
laws of Hong Kong Special Administrative Region.

## **INDIA**

**Limitation of Liability:** *The following replaces items 1 and 2 of this Section:*

1. liability for bodily injury (including death) or damage to real property and tangible personal property will be limited to that caused by IBM's negligence;
2. as to any other actual damage arising in any situation involving nonperformance by IBM pursuant to, or in any way related to the subject of this Statement of Limited Warranty, IBM's liability will be limited to the charge paid by you for the individual Machine that is the subject of the claim.

## **JAPAN**

**Governing Law:** *The following sentence is added to this Section:*

Any doubts concerning this Agreement will be initially resolved between us in good faith and in accordance with the principle of mutual trust.

## **NEW ZEALAND**

**The IBM Warranty for Machines:** *The following paragraph is added to this Section:*

The warranties specified in this Section are in addition to any rights you may have under the Consumer Guarantees Act 1993 or other legislation which cannot be excluded or limited. The Consumer Guarantees Act 1993 will not apply in respect of any goods which IBM provides, if you require the goods for the purposes of a business as defined in that Act.

**Limitation of Liability:** *The following is added to this Section:*

Where Machines are not acquired for the purposes of a business as defined in the Consumer Guarantees Act 1993, the limitations in this Section are subject to the limitations in that Act.

## **PEOPLE'S REPUBLIC OF CHINA (PRC)**

**Governing Law:** *The following replaces this Section:*

Both you and IBM consent to the application of the laws of the State of New York (except when local law requires otherwise) to govern, interpret, and enforce all your and IBM's rights, duties, and obligations arising from, or relating in any manner to, the subject matter of this Agreement, without regard to conflict of law principles.

Any disputes arising from or in connection with this Agreement will first be resolved by friendly negotiations, failing which either of us has the right to submit the dispute to the China International Economic and Trade Arbitration Commission in Beijing, the PRC, for arbitration in accordance with its arbitration rules in force at the time. The arbitration tribunal will consist of three arbitrators. The language to be used therein will be English and Chinese. An arbitral award will be final and binding on all the parties, and will be enforceable under the Convention on the Recognition and Enforcement of Foreign Arbitral Awards (1958).

The arbitration fee will be borne by the losing party unless otherwise determined by the arbitral award.

During the course of arbitration, this Agreement will continue to be performed except for the part which the parties are disputing and which is undergoing arbitration.

## **EUROPE, MIDDLE EAST, AFRICA (EMEA)**

### ***THE FOLLOWING TERMS APPLY TO ALL EMEA COUNTRIES:***

The terms of this Statement of Limited Warranty apply to Machines purchased from IBM or an IBM reseller.

### **Warranty Service:**

If you purchase an IBM Machine in Austria, Belgium, Denmark, Estonia, Finland, France, Germany, Greece, Iceland, Ireland, Italy, Latvia, Lithuania, Luxembourg, Netherlands, Norway, Portugal, Spain, Sweden, Switzerland or United Kingdom, you may obtain warranty service for that Machine in any of those countries from either (1) an IBM reseller approved to perform warranty service or (2) from IBM. If you purchase an IBM Personal Computer Machine in Albania, Armenia, Belarus, Bosnia and Herzegovina, Bulgaria, Croatia, Czech Republic, Georgia, Hungary, Kazakhstan, Kirghizia, Federal Republic of Yugoslavia, Former Yugoslav Republic of Macedonia (FYROM), Moldova, Poland, Romania, Russia, Slovak Republic, Slovenia, or Ukraine, you may obtain warranty service for that Machine in any of those countries from either (1) an IBM reseller approved to perform warranty service or (2) from IBM.

If you purchase an IBM Machine in a Middle Eastern or African country, you may obtain warranty service for that Machine from the IBM entity within the country of purchase, if that IBM entity provides warranty service in that country, or from an IBM reseller, approved by IBM to perform warranty service on that Machine in that country. Warranty service in Africa is available within 50 kilometers of an IBM authorized service provider. You are responsible for transportation costs for Machines located outside 50 kilometers of an IBM authorized service provider.

### **Governing Law:**

The applicable laws that govern, interpret and enforce rights, duties, and obligations of each of us arising from, or relating in any manner to, the subject matter of this



Statement, without regard to conflict of laws principles, as well as Country-unique terms and competent court for this Statement are those of the country in which the warranty service is being provided, except that in 1) Albania, Bosnia-Herzegovina, Bulgaria, Croatia, Hungary, Former Yugoslav Republic of Macedonia, Romania, Slovakia, Slovenia, Armenia, Azerbaijan, Belarus, Georgia, Kazakhstan, Kyrgyzstan, Moldova, Russia, Tajikistan, Turkmenistan, Ukraine, and Uzbekistan, the laws of Austria apply; 2) Estonia, Latvia, and Lithuania, the laws of Finland apply; 3) Algeria, Benin, Burkina Faso, Cameroon, Cape Verde, Central African Republic, Chad, Congo, Djibouti, Democratic Republic of Congo, Equatorial Guinea, France, Gabon, Gambia, Guinea, Guinea-Bissau, Ivory Coast, Lebanon, Mali, Mauritania, Morocco, Niger, Senegal, Togo, and Tunisia, this Agreement will be construed and the legal relations between the parties will be determined in accordance with the French laws and all disputes arising out of this Agreement or related to its violation or execution, including summary proceedings, will be settled exclusively by the Commercial Court of Paris; 4) Angola, Bahrain, Botswana, Burundi, Egypt, Eritrea, Ethiopia, Ghana, Jordan, Kenya, Kuwait, Liberia, Malawi, Malta, Mozambique, Nigeria, Oman, Pakistan, Qatar, Rwanda, Sao Tome, Saudi Arabia, Sierra Leone, Somalia, Tanzania, Uganda, United Arab Emirates, United Kingdom, West Bank/Gaza, Yemen, Zambia, and Zimbabwe, this Agreement will be governed by English Law and disputes relating to it will be submitted to the exclusive jurisdiction of the English courts; and 5) in Greece, Israel, Italy, Portugal, and Spain any legal claim arising out of this Statement will be brought before, and finally settled by, the competent court of Athens, Tel Aviv, Milan, Lisbon, and Madrid, respectively.

***THE FOLLOWING TERMS APPLY TO THE COUNTRY SPECIFIED:***

**AUSTRIA AND GERMANY**

**The IBM Warranty for Machines:** *The following replaces the first sentence of the first paragraph of this Section:*

The warranty for an IBM Machine covers the functionality of the Machine for its normal use and the Machine's conformity to its Specifications.

*The following paragraphs are added to this Section:*

The minimum warranty period for Machines is six months. In case IBM or your reseller is unable to repair an IBM Machine, you can alternatively ask for a partial refund as far as justified by the reduced value of the unrepaired Machine or ask for a cancellation of the respective agreement for such Machine and get your money refunded.

**Extent of Warranty:** *The second paragraph does not apply.*

**Warranty Service:** *The following is added to this Section:*

During the warranty period, transportation for delivery of the failing Machine to IBM will be at IBM's expense.

**Limitation of Liability:** *The following paragraph is added to this Section:*

The limitations and exclusions specified in the Statement of Limited Warranty will not apply to damages caused by IBM with fraud or gross negligence and for express warranty.

*The following sentence is added to the end of item 2:*

IBM's liability under this item is limited to the violation of essential contractual terms in cases of ordinary negligence.

**EGYPT**

**Limitation of Liability:** *The following replaces item 2 in this Section:*

as to any other actual direct damages, IBM's liability will be limited to the total amount you paid for the Machine that is the subject of the claim. For purposes of this item, the term "Machine" includes Machine Code and Licensed Internal Code.

*Applicability of suppliers and resellers (unchanged).*

## FRANCE

**Limitation of Liability:** *The following replaces the second sentence of the first paragraph of this Section:*

In such instances, regardless of the basis on which you are entitled to claim damages from IBM, IBM is liable for no more than: *(items 1 and 2 unchanged).*

## IRELAND

**Extent of Warranty:** *The following is added to this Section:*

Except as expressly provided in these terms and conditions, all statutory conditions, including all warranties implied, but without prejudice to the generality of the foregoing all warranties implied by the Sale of Goods Act 1893 or the Sale of Goods and Supply of Services Act 1980 are hereby excluded.

**Limitation of Liability:** *The following replaces items one and two of the first paragraph of this Section:*

1. death or personal injury or physical damage to your real property solely caused by IBM's negligence; and
2. the amount of any other actual direct damages, up to 125 percent of the charges (if recurring, the 12 months' charges apply) for the Machine that is the subject of the claim or which otherwise gives rise to the claim.

*Applicability of suppliers and resellers (unchanged).*

*The following paragraph is added at the end of this Section:*

IBM's entire liability and your sole remedy, whether in contract or in tort, in respect of any default shall be limited to damages.

## ITALY

**Limitation of Liability:** *The following replaces the second sentence in the first paragraph:*

In each such instance unless otherwise provided by mandatory law, IBM is liable for no more than:

1. *(unchanged)*
2. as to any other actual damage arising in all situations involving nonperformance by IBM pursuant to, or in any way related to the subject matter of this Statement of Warranty, IBM's liability, will be limited to the total amount you paid for the Machine that is the subject of the claim.

*Applicability of suppliers and resellers (unchanged).*

*The following replaces the third paragraph of this Section:*

Unless otherwise provided by mandatory law, IBM and your reseller are not liable for any of the following: *(items 1 and 2 unchanged)* 3) indirect damages, even if IBM or your reseller is informed of their possibility.

## SOUTH AFRICA, NAMIBIA, BOTSWANA, LESOTHO AND SWAZILAND

**Limitation of Liability:** *The following is added to this Section:*

IBM's entire liability to you for actual damages arising in all situations involving nonperformance by IBM in respect of the subject matter of this Statement of Warranty will be limited to the charge paid by you for the individual Machine that is the subject of your claim from IBM.

## UNITED KINGDOM

**Limitation of Liability:** *The following replaces items 1 and 2 of the first paragraph of this Section:*

1. death or personal injury or physical damage to your real property solely caused by IBM's negligence;
2. the amount of any other actual direct damages or loss, up to 125 percent of the charges (if recurring, the 12 months' charges apply) for the Machine that is the subject of the claim or which otherwise gives rise to the claim;

*The following item is added to this paragraph:*

3. breach of IBM's obligations implied by Section 12 of the Sale of Goods Act 1979 or Section 2 of the Supply of Goods and Services Act 1982.

*Applicability of suppliers and resellers (unchanged).*

*The following is added to the end of this Section:*

IBM's entire liability and your sole remedy, whether in contract or in tort, in respect of any default shall be limited to damages.

---

## Notices

This publication was developed for products and services offered in the U.S.A.

IBM may not offer the products, services, or features discussed in this document in other countries. Consult your local IBM representative for information on the products and services currently available in your area. Any reference to an IBM product, program, or service is not intended to state or imply that only that IBM product, program, or service may be used. Any functionally equivalent product, program, or service that does not infringe any IBM intellectual property right may be used instead. However, it is the user's responsibility to evaluate and verify the operation of any non-IBM product, program, or service.

IBM may have patents or pending patent applications covering subject matter described in this document. The furnishing of this document does not give you any license to these patents. You can send license inquiries, in writing, to:

*IBM Director of Licensing  
IBM Corporation  
North Castle Drive  
Armonk, NY 10504-1785  
U.S.A.*

INTERNATIONAL BUSINESS MACHINES CORPORATION PROVIDES THIS PUBLICATION "AS IS" WITHOUT WARRANTY OF ANY KIND, EITHER EXPRESS OR IMPLIED, INCLUDING, BUT NOT LIMITED TO, THE IMPLIED WARRANTIES OF NON-INFRINGEMENT, MERCHANTABILITY OR FITNESS FOR A PARTICULAR PURPOSE. Some states do not allow disclaimer of express or implied warranties in certain transactions, therefore, this statement may not apply to you.

This information could include technical inaccuracies or typographical errors. Changes are periodically made to the information herein; these changes will be incorporated in new editions of the publication. IBM may make improvements and/or changes in the product(s) and/or the program(s) described in this publication at any time without notice.

Any references in this publication to non-IBM Web sites are provided for convenience only and do not in any manner serve as an endorsement of those Web sites. The materials at those Web sites are not part of the materials for this IBM product, and use of those Web sites is at your own risk.

IBM may use or distribute any of the information you supply in any way it believes appropriate without incurring any obligation to you.

## Edition notice

© COPYRIGHT INTERNATIONAL BUSINESS MACHINES CORPORATION, 2001.  
All rights reserved.

Note to U.S. Government Users — Documentation related to restricted rights — Use, duplication or disclosure is subject to restrictions set forth in GSA ADP Schedule Contract with IBM Corp.

## Processing date data

This IBM hardware product and IBM software products that might be packaged with it have been designed, when used in accordance with their associated documentation, to process date data correctly within and between the 20th and 21st centuries, provided all other products (for example, software, hardware, and firmware) used with these products properly exchange accurate date data with them.

IBM cannot take responsibility for the date data processing capabilities of non-IBM products, even if those products are preinstalled or otherwise distributed by IBM. You should contact the vendors responsible for those products directly to determine the capabilities of their products and update them if needed. This IBM hardware product cannot prevent errors that might occur if software, upgrades, or peripheral devices you use or exchange data with do not process date data correctly.

The foregoing is a Year 2000 Readiness Disclosure.

## Trademarks

The following terms are trademarks of the IBM Corporation in the United States, other countries, or both:

Alert on LAN	ServeRAID
EtherJet	ServerGuide
HelpCenter	ServerProven
e-business logo	TechConnect
HelpWare	Update Connector
IBM	Wake on LAN
OS/2 WARP	xSeries
Predictive Failure Analysis	

Lotus and Domino are trademarks of Lotus Development Corporation in the United States, other countries, or both.

Tivoli and NetView are trademarks of Tivoli Systems Inc. in the United States, other countries, or both.

Intel, MMX, LANDesk, Pentium, Celeron, Pentium II Xeon, and Pentium III Xeon are trademarks of Intel Corporation in the United States, other countries, or both.

Microsoft, Windows, and Windows NT are trademarks of Microsoft Corporation in the United States, other countries, or both.

UNIX is a registered trademark of The Open Group in the United States and other countries.

Java and all Java-based trademarks and logos are trademarks or registered trademarks of Sun Microsystems, Inc. in the United States, other countries, or both.

Other company, product, and service names may be trademarks or service marks of others.

## Important notes

Processor speeds indicate the internal clock speed of the microprocessor; other factors also affect application performance.

When referring to hard disk drive capacity, MB stands for 1 000 000 bytes and GB stands for 1 000 000 000 bytes. Total user-accessible capacity may vary depending on operating environments.

Maximum internal hard disk drive capacities assume the replacement of any standard hard disk drives and population of all hard disk drive bays with the largest currently supported drives available from IBM.

Unless otherwise stated, IBM makes no representations or warranties with respect to non-IBM products. Support (if any) for the non-IBM products is provided by the third party, not IBM.

Some software may differ from its retail version (if available), and may not include user manuals or all program functionality.

---

## Electronic emission notices

### Federal Communications Commission (FCC) Statement

**Note:** This equipment has been tested and found to comply with the limits for a Class A digital device, pursuant to Part 15 of the FCC Rules. These limits are designed to provide reasonable protection against harmful interference when the equipment is operated in a commercial environment. This equipment generates, uses, and can radiate radio frequency energy and, if not installed and used in accordance with the instruction manual, may cause harmful interference to radio communications. Operation of this equipment in a residential area is likely to cause harmful interference, in which case the user will be required to correct the interference at his own expense.

Properly shielded and grounded cables and connectors must be used in order to meet FCC emission limits. IBM is not responsible for any radio or television interference caused by using other than recommended cables and connectors or by unauthorized changes or modifications to this equipment. Unauthorized changes or modifications could void the user's authority to operate the equipment.

This device complies with Part 15 of the FCC Rules. Operation is subject to the following two conditions: (1) this device may not cause harmful interference, and (2) this device must accept any interference received, including interference that may cause undesired operation.

### Industry Canada Class A emission compliance statement

This Class A digital apparatus complies with Canadian ICES-003.

## Avis de conformité à la réglementation d'Industrie Canada

Cet appareil numérique de classe A est conforme à la norme NMB-003 du Canada.

## Australia and New Zealand Class A statement

**Attention:** This is a Class A product. In a domestic environment this product may cause radio interference in which case the user may be required to take adequate measures.

## United Kingdom telecommunications safety requirement

### Notice to Customers

This apparatus is approved under approval number NS/G/1234/J/100003 for indirect connection to public telecommunication systems in the United Kingdom.

## European Union EMC Directive conformance statement

This product is in conformity with the protection requirements of EU Council Directive 89/336/EEC on the approximation of the laws of the Member States relating to electromagnetic compatibility. IBM cannot accept responsibility for any failure to satisfy the protection requirements resulting from a nonrecommended modification of the product, including the fitting of non-IBM option cards.

This product has been tested and found to comply with the limits for Class A Information Technology Equipment according to CISPR 22/European Standard EN 55022. The Limits for Class A equipment were derived for commercial and industrial environments to provide reasonable protection against interference with licensed communication equipment.

**Attention:** This is a Class A product. In a domestic environment this product may cause radio interference in which case the user may be required to take adequate measures.

## Taiwan electrical emission statement

警告使用者：  
這是甲類的資訊產品，在居住的環境中使用時，可能會造成射頻干擾，在這種情況下，使用者會被要求採取某些適當的對策。

## Japanese Voluntary Control Council for Interference (VCCI) statement

この装置は、情報処理装置等電波障害自主規制協議会（VCCI）の基準に基づくクラスA情報技術装置です。この装置を家庭環境で使用すると電波妨害を引き起こすことがあります。この場合には使用者が適切な対策を講ずるよう要求されることがあります。

### Power cords

For your safety, IBM provides a power cord with a grounded attachment plug to use with this IBM product. To avoid electrical shock, always use the power cord and plug with a properly grounded outlet.

IBM power cords used in the United States and Canada are listed by Underwriter's Laboratories (UL) and certified by the Canadian Standards Association (CSA).

For units intended to be operated at 115 volts: Use a UL-listed and CSA-certified cord set consisting of a minimum 18 AWG, Type SVT or SJT, three-conductor cord, a maximum of 15 feet in length and a parallel blade, grounding-type attachment plug rated 15 amperes, 125 volts.

For units intended to be operated at 230 volts (U.S. use): Use a UL-listed and CSA-certified cord set consisting of a minimum 18 AWG, Type SVT or SJT, three-conductor cord, a maximum of 15 feet in length and a tandem blade, grounding-type attachment plug rated 15 amperes, 250 volts.

For units intended to be operated at 230 volts (outside the U.S.): Use a cord set with a grounding-type attachment plug. The cord set should have the appropriate safety approvals for the country in which the equipment will be installed.

IBM power cords for a specific country or region are usually available only in that country or region.

IBM power cord part number	Used in these countries and regions
13F9940	Argentina, Australia, China (PRC), New Zealand, Papua New Guinea, Paraguay, Uruguay, Western Samoa
13F9979	Afghanistan, Algeria, Andorra, Angola, Austria, Belgium, Benin, Bulgaria, Burkina Faso, Burundi, Cameroon, Central African Rep., Chad, China (Macau S.A.R.), Czech Republic, Egypt, Finland, France, French Guiana, Germany, Greece, Guinea, Hungary, Iceland, Indonesia, Iran, Ivory Coast, Jordan, Lebanon, Luxembourg, Malagasy, Mali, Martinique, Mauritania, Mauritius, Monaco, Morocco, Mozambique, Netherlands, New Caledonia, Niger, Norway, Poland, Portugal, Romania, Senegal, Slovakia, Spain, Sudan, Sweden, Syria, Togo, Tunisia, Turkey, former USSR, Vietnam, former Yugoslavia, Zaire, Zimbabwe
13F9997	Denmark
14F0015	Bangladesh, Burma, Pakistan, South Africa, Sri Lanka

IBM power cord part number	Used in these countries and regions
14F0033	Antigua, Bahrain, Brunei, Channel Islands, China (Hong Kong S.A.R.), Cyprus, Dubai, Fiji, Ghana, India, Iraq, Ireland, Kenya, Kuwait, Malawi, Malaysia, Malta, Nepal, Nigeria, Polynesia, Qatar, Sierra Leone, Singapore, Tanzania, Uganda, United Kingdom, Yemen, Zambia
14F0051	Liechtenstein, Switzerland
14F0069	Chile, Ethiopia, Italy, Libya, Somalia
14F0087	Israel
1838574	Thailand
6952301	Bahamas, Barbados, Bermuda, Bolivia, Brazil, Canada, Cayman Islands, Colombia, Costa Rica, Dominican Republic, Ecuador, El Salvador, Guatemala, Guyana, Haiti, Honduras, Jamaica, Japan, Korea (South), Liberia, Mexico, Netherlands Antilles, Nicaragua, Panama, Peru, Philippines, Saudi Arabia, Suriname, Taiwan, Trinidad (West Indies), United States of America, Venezuela



# Index

## A

- acoustical noise emissions 2
- adapter
  - installing 39
  - PCI bus 39
  - working with 38
- adapter fault tolerance 52
- adaptive load balancing 52
- advanced configuration options 17
- advanced setup 15
- assistance, technical 93
- Automated Fax System 95

## B

- battery replacement 92
- BIOS, restoring 78

## C

- cabling
  - Ethernet 51
- cache control 15
- CD-ROM
  - drive specification 2
  - problems 80
- CDs
  - ServerGuide 22
- chipset feature 15
- Class A electronic emission notice 111
- components
  - location of 27
- configuration
  - with ServerGuide 23
- Configuration/Setup Utility 13
  - main menu 14
- configure host adapter settings 17
- configuring
  - Ethernet 51
  - your server 13
- connector and port locations 47
- controller
  - Ethernet 51
- cooling 30
- core chipset control 15
- cover
  - installing 46
  - removing 37
- creating VLAN 54
- customer support and service 95

## D

- data rate

- Ethernet 51
- date and time 15
- devices and I/O ports 14
- diagnostic
  - error code format 68
  - error message tables 72
  - programs and error messages 68
  - programs, starting 69
  - test log, viewing 70, 71
  - text messages 69
- diagnostic tools 55
- DIMMs
  - connector locations 43
  - considerations 43
  - installing 43
  - specifications 2, 4
  - supported 2
- diskette drive
  - problem 80
  - specifications 2

## E

- electrical input 2
- electronic emission Class A notice 111
- electronic support services 95
- emission requirements
  - electronic emission Class A notice 111
  - FCC Class A notice 111
- environment
  - air temperature 2
  - humidity 2
- error
  - diagnostic code format 68
  - ServerGuide symptoms 25
- error messages
  - diagnostic 68, 72
  - POST 60
- Ethernet
  - adapter fault tolerance 52
  - adaptive load balancing 52
  - cabling 51
  - Cisco Fast EtherChannel 52
  - configuring 51
  - creating VLAN 54
  - error messages 86
  - failover 51
  - high performance modes 52
  - IntraNetWare error messages 86
  - modes 52
  - NetWare error messages 86
  - pin-number assignment 54
  - priority filters 52
  - priority packet mode 52
  - teaming 52
  - troubleshooting information 83
  - VLAN 53
  - Windows NT error messages 87

- Ethernet controller 4
- Ethernet port 51
- exit without saving 16
- expansion bays 2
- expansion enclosure
  - problem 80
- expansion slots 2
  - location 38
  - type 38

## F

- failover
  - Ethernet 51
- fan, replacing 45
- fax
  - receiving technical information 95
- FCC Class A notice 111
- features
  - server 4
  - ServerGuide 22
- features and specifications 2
- filters
  - priority 52
- frequency control 15

## H

- handling static-sensitive devices 30
- hard disk controller 2
- hard disk drive
  - IDE 42
  - installing 42
  - specifications 42
- hardware
  - problems 55
- hardware, major 27
- heat output 2
- help
  - by telephone 96
- help information 93
- high priority queue 52
- host adapter
  - SCSI ID 17
  - SCSI termination 17
- host adapter settings, configure 17

## I

- I/O connectors 47
- IEEE 802.1p tagging 52
- important notes 111
- installing
  - adapters 39
  - battery 92
  - cover 46
  - memory modules 43
  - options 27
- integrated

- Ethernet 51
- integrated functions 2
- internal connectors 28

## K

- keyboard
  - connector 49
  - problem 80
  - speed 14

## L

- LEDs
  - front view 6
  - rear view 7
- load optimized defaults 15
- local area network
  - Ethernet 51

## M

- maximum sync transfer rate 17
- memory
  - configuration changes 43
  - problem 81
  - settings 15
  - specifications 2
- memory module
  - installing 43
  - order of installation 43
  - specifications 2, 4
  - supported 43
- messages
  - diagnostic error 68, 72
  - diagnostic text 69
  - Ethernet controller 86
  - POST error 60
- microprocessor
  - cache 15
  - specifications 2
- modes 51
  - Ethernet 52
- mouse
  - connector 50
  - problem 81

## N

- network
  - support line 98
- network connection
  - problems 83
- networks 51
- NOS installation
  - with ServerGuide 24
  - without ServerGuide 25

notices  
  electronic emission, Class A 111  
  FCC, Class A 111  
  miscellaneous 111  
  product 111  
  trademarks 110

## O

option  
  installing 27  
  problem 82  
ordering publications 99

## P

parity checking, SCSI 17  
password  
  forgotten power-on 16  
  using 16  
PCI  
  expansion slots 38  
PCI configuration 15  
PCI plug and play  
  Ethernet 51  
pin-number assignments  
  Ethernet 54  
plug and play  
  Ethernet 51  
pointing device  
  connector 50  
  problem 81  
port  
  Ethernet 51  
  serial 47  
  serial connector 48  
  USB 48  
  USB connector 49  
POST  
  error messages 60  
POST (power-on self-test) 57  
power  
  cords 113  
  management setup 15  
  problem 82  
  supply specifications 2  
priority  
  filters 52  
  levels 52  
  packet mode 52  
problem  
  CD-ROM 80  
  diskette drive 80  
  hardware 55  
  intermittent 80  
  keyboard or mouse 80  
  memory 81  
  network connection 83  
  option 82  
  power 82

  serial port 83  
  software 83  
  USB port 83  
product  
  data 14  
  notices 111  
profile  
  customize support 95  
PXE boot agent utility 13

## R

reliability, system 30  
replace  
  fan 45  
ROM shadowing 15

## S

Safety vii, 31  
safety information  
  electrical 33  
  laser 34  
  lifting 35  
save & exit setup 15  
SCSI  
  device configuration 17  
  disk utilities 17  
  parity checking 17  
SCSISelect  
  boot device options 17  
  menu choices available 17  
  Utility 13  
SCSISelect utility program  
  starting 16  
  using 16  
serial  
  connector or port 47  
serial port  
  problem 83  
ServerGuide  
  additional programs 25  
  CDs 4, 13  
  error symptoms 25  
  features 22  
  NOS installation 24  
  setting up multiple servers 24  
  using 21  
service  
  support 94  
service information 93  
services  
  purchasing additional 97  
setting up  
  multiple servers 24  
setup  
  advanced 15  
  with ServerGuide 23  
slots See expansion slots 38  
software

- problem 83
- software coupon
  - ServerGuide 21
- specifications and features 2
- standby mode 9
- start options 14
- Start Up Support 96
- startup sequence 15
- support line services
  - ordering 98
- support services
  - electronic 95
- switches and jumpers 29
- system
  - management 4
  - reliability 30
  - security 15
  - summary 14
- system board
  - internal connectors 28
  - switches and jumpers 29

## T

- teaming 52
- temperature
  - air 2
- test log
  - viewing diagnostic 70, 71
- time and date 15
- trademarks 110
- traffic class expediting 52
- troubleshooting 55
  - Ethernet 83
- troubleshooting charts 79

## U

- United States electronic emission Class A notice 111
- United States FCC Class A notice 111
- USB
  - cables and hubs 48
  - connector 49
  - port connectors 49
- USB port
  - problem 83
- utility
  - Configuration/Setup 13
  - SCSI disk 17

## V

- video controller
  - disabling 38
  - specifications 2
- virtual LAN (VLAN) 53
- virtual LAN mode (VLAN) 53
- virus-warning test 15
- VLAN

- creating 54

## W

- warranty
  - additional service after 98
  - repair services 99
- warranty service 94
  - international 97
- Web addresses 95
- Web site
  - compatible options 43
  - IBM information 93
  - other companies 93
  - ServerGuide 21





Part Number: 25P1580

25P1580

25P1580