



@server

xSeries 450
Type 8688

Installation Guide

Welcome...

Thank you for buying an IBM xSeries server. Your server is based on the X-Architecture technology, and it features superior performance, availability, and scalability.

This server *Installation Guide* contains information for setting up and configuring your server.

For detailed information about your server, view the publications on the Documentation CD.

You can also find the most current information about your server on the IBM Web site at: <http://www.ibm.com/pc/support>

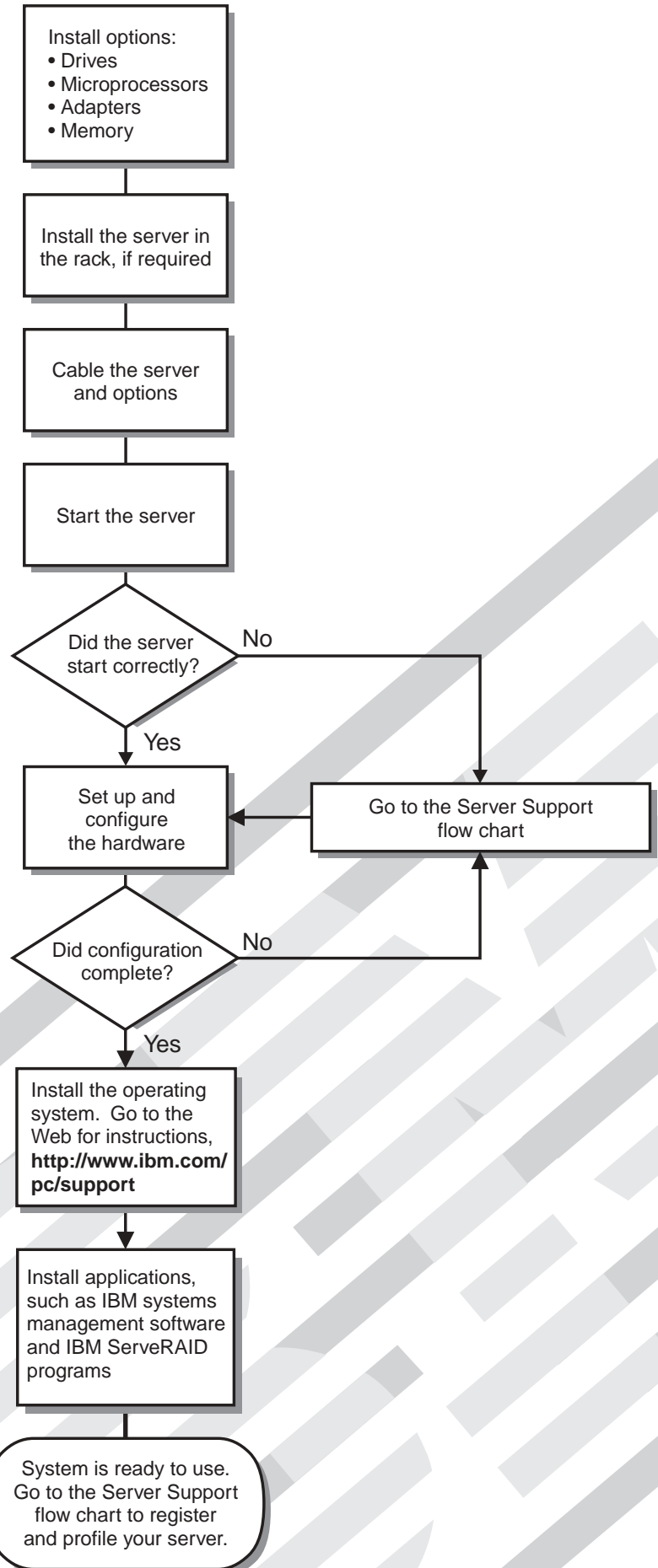

Server Support

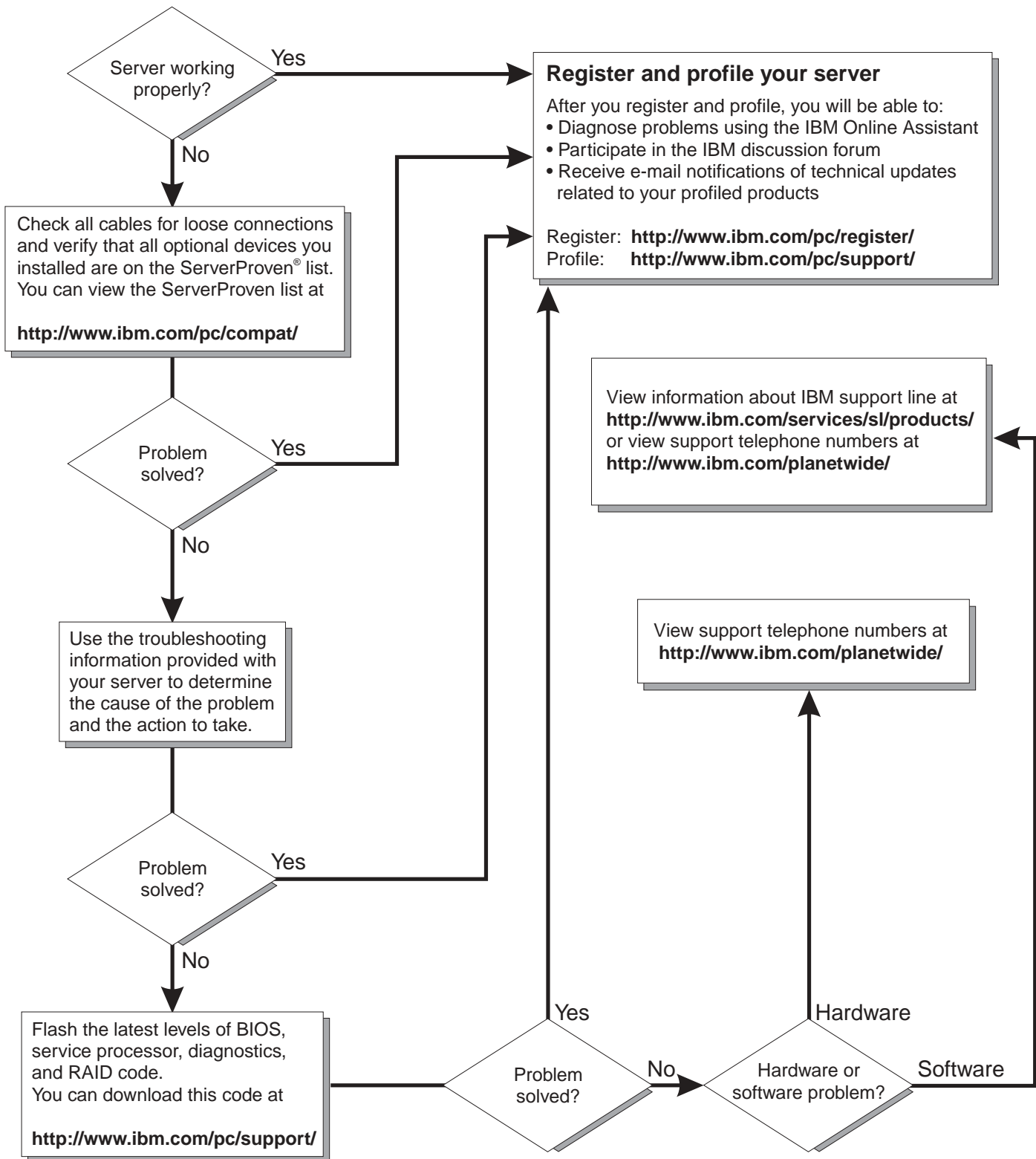

xSeries 450



Installation Guide

Note: Before using this information and the product it supports, read the general information in Appendix A, "Warranty information", on page 47 and Appendix B, "Notices", on page 59.

Third Edition (May 2003)

© Copyright International Business Machines Corporation 2003. All rights reserved.

US Government Users Restricted Rights – Use, duplication or disclosure restricted by GSA ADP Schedule Contract with IBM Corp.

Contents

Safety	v
Chapter 1. Introduction	1
The IBM xSeries Documentation CD	2
Hardware and software requirements	2
Using the Documentation Browser	2
Features and specifications	4
Notices and statements used in this book	5
Major components of the xSeries 450 server	6
Chapter 2. Installing options	9
Installation guidelines	9
System reliability guidelines	9
Working inside a server with power on	9
Handling static-sensitive devices	10
Installing an adapter	10
Installing and replacing a microprocessor and power module	14
Installing memory	20
Completing the installation	22
Connecting the cables	22
Chapter 3. Server controls, LEDs, and power	27
Front view	27
Rear view	28
Server power features	30
Turning on the server	30
Turning off the server	30
Chapter 4. Configuring your server	33
Using the Extensible Firmware Interface (EFI) Boot Manager program	33
Using the Configuration/Setup Utility program	33
Using the LSI Logic Configuration Utility	34
Using the Remote Supervisor Adapter	34
Chapter 5. Solving problems	37
Diagnostic tools overview	37
POST error codes	37
Light Path Diagnostics feature overview	38
Identifying problems using the Light Path Diagnostics feature	38
Light Path Diagnostics table	39
Troubleshooting charts	41
Chapter 6. Getting help and technical assistance	45
Before you call	45
Using the documentation	45
Getting help and information from the World Wide Web	45
Software service and support	46
Hardware service and support	46
Appendix A. Warranty information	47
Warranty period	47
Problem determination	47
Warranty service and support	48

International Warranty Service	48
Purchasing additional services	49
IBM Statement of Limited Warranty Z125-4753-06 8/2000	50
Part 1 - General Terms	50
Part 2 - Country-unique Terms	52
Appendix B. Notices	59
Edition notice	59
Trademarks	60
Important notes.	60
Product recycling and disposal	61
Electronic emission notices	61
Federal Communications Commission (FCC) statement	61
Industry Canada Class A emission compliance statement	62
Australia and New Zealand Class A statement	62
United Kingdom telecommunications safety requirement.	62
European Union EMC Directive conformance statement.	62
Taiwanese Class A warning statement	63
Chinese Class A warning statement	63
Japanese Voluntary Control Council for Interference (VCCI) statement	63
Power cords	63
Index	67

Safety

Before installing this product, read the Safety Information.

قبل تركيب هذا المنتج، يجب قراءة الملاحظات الأمنية

Antes de instalar este produto, leia as Informações de Segurança.

在安装本产品之前，请仔细阅读 **Safety Information**
(安全信息)。

安裝本產品之前，請先閱讀「安全資訊」。

Prije instalacije ovog produkta obavezno pročitajte Sigurnosne Upute.

Před instalací tohoto produktu si přečtěte příručku bezpečnostních instrukcí.

Læs sikkerhedsforskrifterne, før du installerer dette produkt.

Lees voordat u dit product installeert eerst de veiligheidsvoorschriften.

Ennen kuin asennat tämän tuotteen, lue turvaohjeet kohdasta Safety Information.

Avant d'installer ce produit, lisez les consignes de sécurité.

Vor der Installation dieses Produkts die Sicherheitshinweise lesen.

Πριν εγκαταστήσετε το προϊόν αυτό, διαβάστε τις πληροφορίες ασφάλειας
(safety information).

לפני שתתקינו מוצר זה, קראו את הוראות הבטיחות.

A termék telepítése előtt olvassa el a Biztonsági előírásokat!

Prima di installare questo prodotto, leggere le Informazioni sulla Sicurezza.

製品の設置の前に、安全情報をお読みください。

본 제품을 설치하기 전에 안전 정보를 읽으십시오.

Пред да се инсталира овој продукт, прочитајте информацијата за безбедност.

Les sikkerhetsinformasjonen (Safety Information) før du installerer dette produktet.

Przed zainstalowaniem tego produktu, należy zapoznać się
z książką "Informacje dotyczące bezpieczeństwa" (Safety Information).

Antes de instalar este produto, leia as Informações sobre Segurança.

Перед установкой продукта прочтите инструкции по
технике безопасности.

Pred inštaláciou tohto zariadenia si pečítajte Bezpečnostné predpisy.

Pred namestitvijo tega proizvoda preberite Varnostne informacije.

Antes de instalar este producto, lea la información de seguridad.

Läs säkerhetsinformationen innan du installerar den här produkten.

Statement 1:



DANGER

Electrical current from power, telephone, and communication cables is hazardous.

To avoid a shock hazard:

- **Do not connect or disconnect any cables or perform installation, maintenance, or reconfiguration of this product during an electrical storm.**
- **Connect all power cords to a properly wired and grounded electrical outlet.**
- **Connect to properly wired outlets any equipment that will be attached to this product.**
- **When possible, use one hand only to connect or disconnect signal cables.**
- **Never turn on any equipment when there is evidence of fire, water, or structural damage.**
- **Disconnect the attached power cords, telecommunications systems, networks, and modems before you open the device covers, unless instructed otherwise in the installation and configuration procedures.**
- **Connect and disconnect cables as described in the following table when installing, moving, or opening covers on this product or attached devices.**

To Connect:	To Disconnect:
1. Turn everything OFF.	1. Turn everything OFF.
2. First, attach all cables to devices.	2. First, remove power cords from outlet.
3. Attach signal cables to connectors.	3. Remove signal cables from connectors.
4. Attach power cords to outlet.	4. Remove all cables from devices.
5. Turn device ON.	

Statement 2:



CAUTION:

When replacing the lithium battery, use only IBM Part Number 33F8354 or an equivalent type battery recommended by the manufacturer. If your system has a module containing a lithium battery, replace it only with the same module type made by the same manufacturer. The battery contains lithium and can explode if not properly used, handled, or disposed of.

Do not:

- Throw or immerse into water
- Heat to more than 100°C (212°F)
- Repair or disassemble

Dispose of the battery as required by local ordinances or regulations.

Statement 3:



CAUTION:

When laser products (such as CD-ROMs, DVD drives, fiber optic devices, or transmitters) are installed, note the following:

- Do not remove the covers. Removing the covers of the laser product could result in exposure to hazardous laser radiation. There are no serviceable parts inside the device.
- Use of controls or adjustments or performance of procedures other than those specified herein might result in hazardous radiation exposure.



DANGER

Some laser products contain an embedded Class 3A or Class 3B laser diode. Note the following.

Laser radiation when open. Do not stare into the beam, do not view directly with optical instruments, and avoid direct exposure to the beam.

Statement 4:

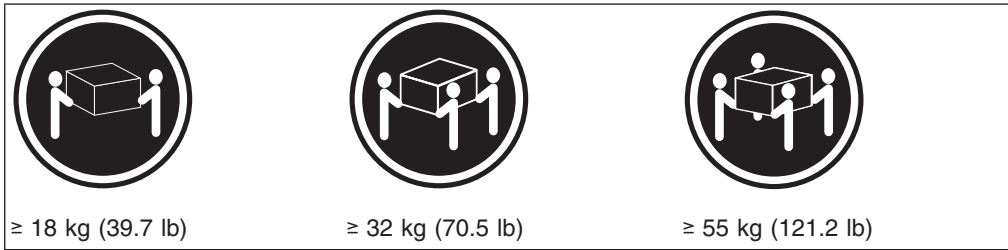

CAUTION:
Use safe practices when lifting.

Statement 5:



CAUTION:
The power control button on the device and the power switch on the power supply do not turn off the electrical current supplied to the device. The device also might have more than one power cord. To remove all electrical current from the device, ensure that all power cords are disconnected from the power source.

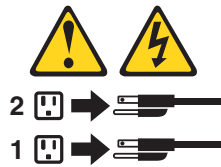

Statement 8:



CAUTION:

Never remove the cover on a power supply or any part that has the following label attached.



Hazardous voltage, current, and energy levels are present inside any component that has this label attached. There are no serviceable parts inside these components. If you suspect a problem with one of these parts, contact a service technician.

Statement 10:



CAUTION:

Do not place any object weighing more than 82 kg (180 lb) on top of rack-mounted devices.



WARNING: Handling the cord on this product or cords associated with accessories sold with this product, will expose you to lead, a chemical known to the State of California to cause cancer, and birth defects or other reproductive harm. **Wash hands after handling.**

ADVERTENCIA: El contacto con el cable de este producto o con cables de accesorios que se venden junto con este producto, pueden exponerle al plomo, un elemento químico que en el estado de California de los Estados Unidos está considerado como un causante de cancer y de defectos congénitos, además de otros riesgos reproductivos. **Lávese las manos después de usar el producto.**

Chapter 1. Introduction

This *Installation Guide* contains instructions for setting up your IBM® @server™ xSeries™ 450 Type 8688 server and basic instructions for installing some options. More detailed instructions for installing options are in the *Option Installation Guide* on the IBM *xSeries Documentation CD*, which comes with your server. This publication contains information about:

- Setting up and cabling your server
- Starting and configuring your server
- Installing some options
- Solving problems

The latest version of this publication is available from the IBM Web site. Complete the following steps to display a list of publications for your server:

1. From <http://www.ibm.com>, click **Support & downloads**.
2. Click **Search technical support**.
3. In the **Enter PC machine type and model** field, type 8688 and click **Submit**.
4. On the left side of the "xSeries 450 8688 support" page, click **Online publications**.
5. From the **Online publications by category** menu, select the category of publications you want to display.

Your server comes with a limited warranty. If you have access to the World Wide Web, you can obtain up-to-date information about your xSeries 450 model and other IBM server products at <http://www.ibm.com/eserver/xseries/>.

Record information about your server in the following table. You will need this information when you register your server with IBM.

Product name	IBM @server xSeries 450 server
Machine type	8688
Model number	_____
Serial number	_____

The model number and serial number are on the ID label on the left side of the bezel, just above the hard disk drives.

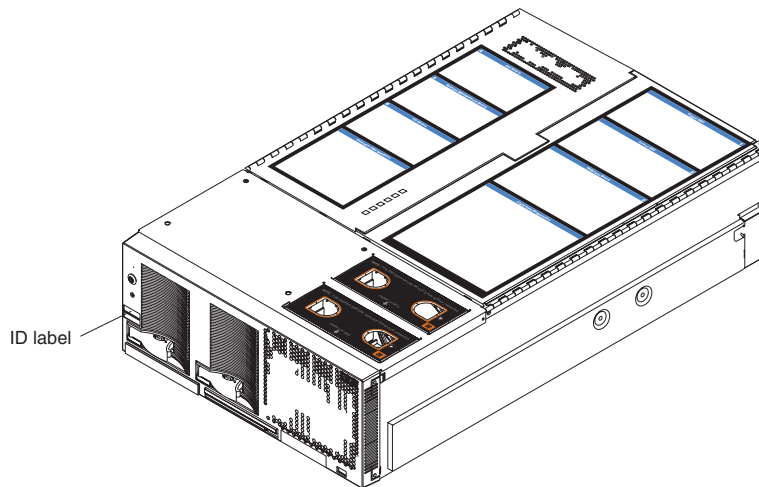

See the *Rack Installation Instructions* publication for complete rack installation and removal instructions.

The IBM xSeries Documentation CD

The IBM *xSeries Documentation* CD contains documentation for your server in Portable Document Format (PDF) and includes the IBM Documentation Browser to help you find information quickly.

Hardware and software requirements

The IBM *xSeries Documentation* CD requires the following minimum hardware and software:

- Microsoft® Windows NT® 4.0 (with Service Pack 3 or later), Windows® 98, or Windows 2000.
- 100 MHz Intel® Pentium® microprocessor.
- 32 MB of RAM.
- Adobe Acrobat Reader 3.0 or later. Acrobat Reader software is included on the CD, and you can install it when you run the Documentation Browser.

Using the Documentation Browser

Use the Documentation Browser to browse the contents of the CD, read brief descriptions of the books, and view books using Adobe Acrobat Reader. The Documentation Browser automatically detects the regional settings in use in your system and displays the books in the language for that region (if available). If a book is not available in the language for that region, the English version is displayed.

Use one of the following procedures to start the Documentation Browser:

- If Autostart is enabled, insert the CD into your CD-ROM drive. The Documentation Browser starts automatically.
- If Autostart is disabled, insert the CD into your CD-ROM drive and click **Start --> Run**. In the **Open** field, type
`e:\win32.bat`

where *e* is the drive letter of your CD-ROM drive, and click **OK**.

Select your server from the **Product** menu. The **Available Topics** list displays all the books for your server. Some books might be in folders. A plus sign (+) indicates each folder or book that has additional books under it. Click the plus sign to display the additional books.

When you select a book, a description of the book appears under **Topic Description**. To select more than one book, press and hold the Ctrl key while you select the books. Click **View Book** to view the selected book or books in Acrobat Reader. If you selected more than one book, all the selected books are opened in Acrobat Reader.

To search all the books, type a word or word string in the **Search** field and click **Search**. The books in which the word or word string appears are listed in order of the most occurrences. Click a book to view it, and press Ctrl+F to use the Acrobat search function within the book.

Click **Help** for detailed information about using the Documentation Browser.

Features and specifications

The following table provides a summary of the features and specifications for your server.

<p>Microprocessor:</p> <ul style="list-style-type: none"> Intel® Itanium® 2 900 MHz or higher, depending on server model 1.5 MB (minimum) Level-3 cache 200 MHz front-side bus (FSB), at two data transfers per cycle, yielding a 400 MHz system bus (minimum) Support for up to four microprocessors XceL4™ Server Accelerator Cache: 64 MB <p>Active Memory™:</p> <ul style="list-style-type: none"> Minimum: 1 GB Maximum: 40 GB Type: 2-way interleaved PC2100, ECC DDR SDRAM, registered DIMMs only Supports 512 MB, 1 GB, and 2 GB dual inline memory modules (DIMMs) <p>Drives standard:</p> <p>DVD/CD-RW: IDE</p> <p>Expansion bays:</p> <ul style="list-style-type: none"> Two removable media bays (one DVD/CD-RW preinstalled) Supports up to two internal Ultra320 SCSI hard disk drives <p>Active™ PCI-X expansion slots:</p> <p>Six 64-bit Active PCI-X expansion slots:</p> <ul style="list-style-type: none"> Two 66 MHz PCI-X slots Two 100 MHz PCI-X slots Two 133 MHz PCI-X slots <p>Cooling:</p> <p>Four hot-swap fans</p> <ul style="list-style-type: none"> Two 150 mm x 51 mm fans Two 150 mm x 38 mm fans <p>Acoustical noise emissions:</p> <ul style="list-style-type: none"> Declared sound power, idle: 6.5 bels Declared sound power, operating: 6.5 bels Bystander sound pressure, idle: 49 dBa Bystander sound pressure, operating: 49 dBa 	<p>Power supply:</p> <p>Two power supplies: 550 watts at 100-127 V ac or 1050 watts at 200-240 V ac (hot-swappable and redundant at 200-240 V ac only)</p> <p>Video:</p> <ul style="list-style-type: none"> Integrated ATI RageXL video PCI bus interface Compatible with SVGA 8 MB SDRAM video memory <p>Size (4 U):</p> <ul style="list-style-type: none"> Height: 17.8 cm (7 inches, 4 U) Depth: 69.85 cm (27.5 inches) Width: 48.3 cm (19 inches) Maximum weight: 38.6 kg (85 lb), depending on your configuration <p>Integrated functions:</p> <ul style="list-style-type: none"> Broadcom 5704 10/100/1000 dual port Ethernet controller Light Path Diagnostics™ One external and one internal Ultra320 SCSI port (dual-channel integrated controller with RAID capabilities) Remote Supervisor Adapter (service processor) <ul style="list-style-type: none"> ASM interconnect (peer-to-peer) port Ethernet port Serial port IDE controller RXE Management Port RXE Expansion Ports Three USB ports SCSI ports Serial port Wake on LAN® <p>Environment:</p> <ul style="list-style-type: none"> Air temperature: <ul style="list-style-type: none"> Server on: 10° to 35°C (50.0° to 95.0°F). Altitude: 0 to 914 m (2998.7 ft) Server on: 10° to 32°C (50.0° to 89.6°F). Altitude: 0 to 2133 m (6998.0 ft) Server off: -40° to 60°C (-104° to 140°F). Maximum altitude: 2133 m (6998.0 ft) Humidity: <ul style="list-style-type: none"> Server on: 8% to 80% Server off: 5% to 100% 	<p>Heat output:</p> <p>Approximate heat output in British thermal units (Btu) per hour</p> <ul style="list-style-type: none"> Minimum configuration: 854 Btu (250 watts) Maximum configuration: 2646 Btu (775 watts) <p>Electrical input:</p> <ul style="list-style-type: none"> Sine-wave input (50-60 Hz) required Input voltage low range: <ul style="list-style-type: none"> Minimum: 100 V ac Maximum: 127 V ac Input voltage high range: <ul style="list-style-type: none"> Minimum: 200 V ac Maximum: 240 V ac Input kilovolt-amperes (kVA) approximately: <ul style="list-style-type: none"> Minimum: 0.250 kVA Maximum: 1.3 kVA <p>Notes:</p> <ol style="list-style-type: none"> Power consumption and heat output vary depending on the number and type of optional features installed and the power-management optional features in use. These levels were measured in controlled acoustical environments according to the procedures specified by the American National Standards Institute (ANSI) S12.10 and ISO 7779 and are reported in accordance with ISO 9296. Actual sound-pressure levels in a given location might exceed the average values stated because of room reflections and other nearby noise sources. The declared sound-power levels indicate an upper limit, below which a large number of computers will operate.
--	--	---

Notices and statements used in this book

The caution and danger statements that appear in this book are also in the multilingual *Safety Information* book, which is on the IBM *xSeries Documentation* CD. Each statement is numbered for reference to the corresponding statement in the *Safety Information* book.

The following notices and statements are used in the documentation:

- **Notes:** These notices provide important tips, guidance, or advice.
- **Important:** These notices provide information or advice that might help you avoid inconvenient or problem situations.
- **Attention:** These notices indicate potential damage to programs, devices, or data. An attention notice is placed just before the instruction or situation in which damage could occur.
- **Caution:** These statements indicate situations that can be potentially hazardous to you. A caution statement is placed just before the description of a potentially hazardous procedure step or situation.
- **Danger:** These statements indicate situations that can be potentially lethal or extremely hazardous to you. A danger statement is placed just before the description of a potentially lethal or extremely hazardous procedure step or situation.

Major components of the xSeries 450 server

The orange color on components and labels in the server indicates hot-swap or hot-plug components. You can install or remove these components while the server is running, provided that the server is configured to support hot-swap and hot-plug components. For information about installing hot-swap and hot-plug components, see Chapter 2, “Installing options”, on page 9.

The blue color on components and labels indicates touch points, where a component can be gripped, a latch moved, and so on.

The following illustration shows the locations of major components in your server.

Note: The illustrations in this publication might differ slightly from your hardware.

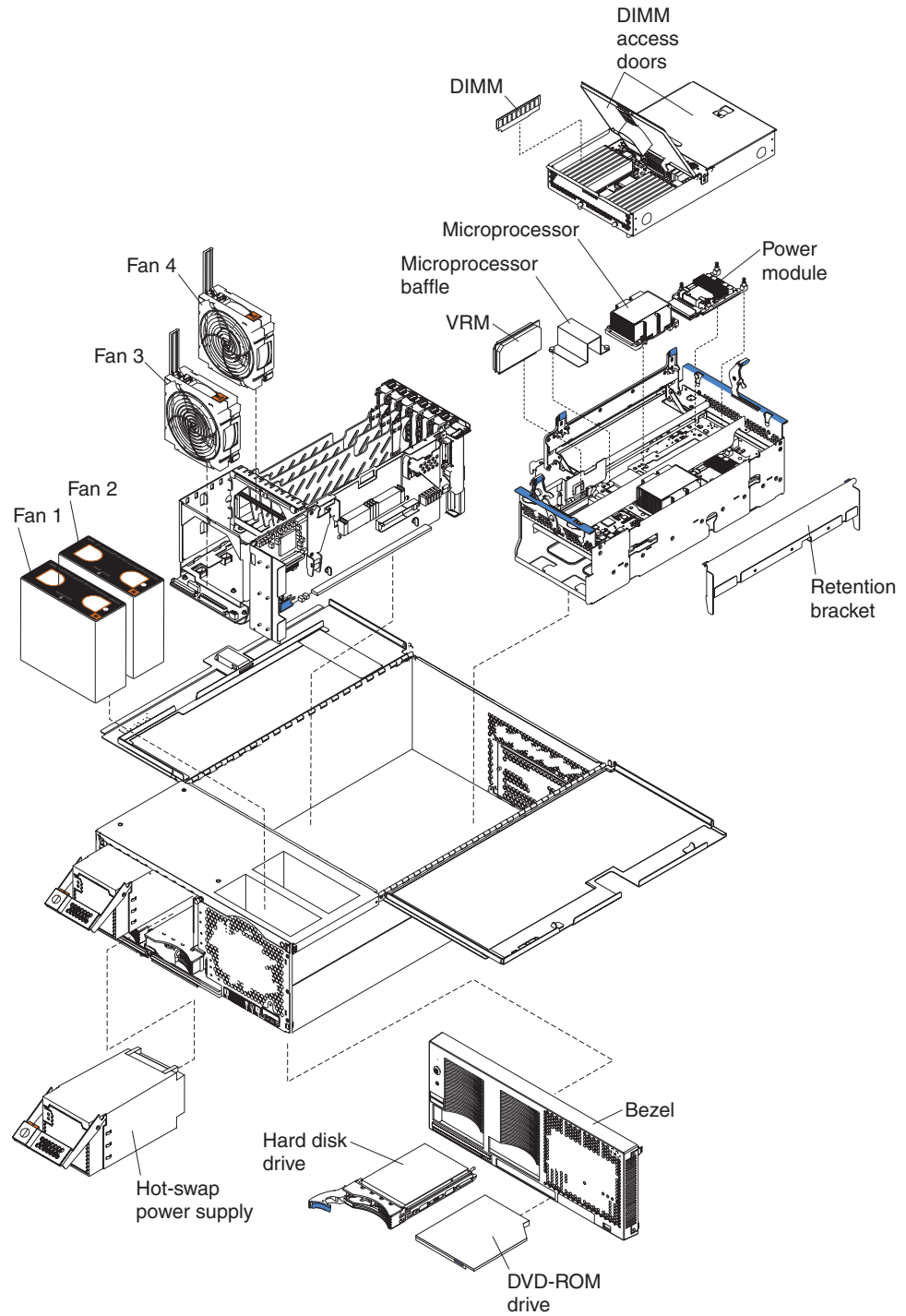

Chapter 2. Installing options

This chapter provides basic instructions for installing hardware options in your server. These instructions are intended for users who are experienced with setting up IBM server hardware. If you need more detailed information, see the *Option Installation Guide* on the IBM xSeries Documentation CD.

Installation guidelines

Before you begin to install options in your server, read the following information:

- Read the safety information beginning on page v and the guidelines in “Handling static-sensitive devices” on page 10. These guidelines will help you work safely with your server or options.
- Make sure that you have an adequate number of properly grounded electrical outlets for your server, monitor, and any other options that you intend to install.
- Back up all important data before you make changes to disk drives.
- The blue color on components and labels indicates touch points, where components can be gripped, a latch moved, and so on.
- For a list of supported options for your server, go to the ServerProven® list at <http://www.ibm.com/pc/us/compat/> on the World Wide Web.

Note: Some preconfigured servers have a unique list of supported options. See the software documentation provided with those servers for more information.

System reliability guidelines

To help ensure proper cooling and system reliability, make sure that:

- Each of the drive bays has a drive or a filler panel and electromagnetic compatibility (EMC) shield installed in it.
- Each of the power-supply bays has a power supply installed in it.
- There is adequate space around the server to allow the server cooling system to work properly. Leave approximately 50 mm (2 in.) of open space around the front and rear of the server. Do not place objects in front of the fans.
- You have followed the cabling instructions that come with optional adapters.
- You have replaced a failed fan as soon as possible.
- You have replaced a hot-swap drive within 2 minutes of removal.
- All microprocessor sockets always contain either a microprocessor baffle or a microprocessor and heat sink.
- For redundant and hot-swappable operation, the power supplies are connected to 200-240 V ac.

Working inside a server with power on

Your server supports hot-swap devices and is designed to operate safely while turned on with the cover removed. Follow these guidelines when you work inside a server that is turned on:

- Avoid loose-fitting clothing on your forearms. Button long-sleeved shirts before working inside the server; do not wear cuff links while you are working inside the server.
- Do not allow your necktie or scarf to hang inside the server.
- Remove jewelry, such as bracelets, rings, necklaces, and loose-fitting wrist watches.

- Remove items from your shirt pocket (such as pens or pencils) that could fall into the server as you lean over it.
- Take care to avoid dropping any metallic objects, such as paper clips, hair pins, or screws, into the server.

Handling static-sensitive devices

Attention: Static electricity can damage electronic devices, including your server. To avoid damage, keep static-sensitive devices in their static-protective package until you are ready to install them.

To reduce the possibility of damage from electrostatic discharge, observe the following precautions:

- Limit your movement. Movement can cause static electricity to build up around you.
- Handle the device carefully, holding it by its edges or its frame.
- Do not touch solder joints, pins, or exposed printed circuitry.
- Do not leave the device where others can handle and possibly damage the device.
- While the device is still in its anti-static package, touch it to an unpainted metal part of the system unit for at least 2 seconds. (This drains static electricity from the package and from your body.)
- Remove the device from its package and install it directly into your system unit without setting it down. If it is necessary to set the device down, place it in its static-protective package. Do not place the device on your system unit cover or on a metal table.
- Take additional care when handling devices during cold weather as heating reduces indoor humidity and increases static electricity.
- Wear a properly grounded wrist strap against your skin to help eliminate static electricity from your body.

Installing an adapter

The following notes describe the types of adapters that your server supports and other information that you must consider when installing an adapter:

- The following illustration shows the location and bus speeds of the PCI-X expansion slots on the PCI-X board.

Note: The illustrations in this publication might differ slightly from your hardware.

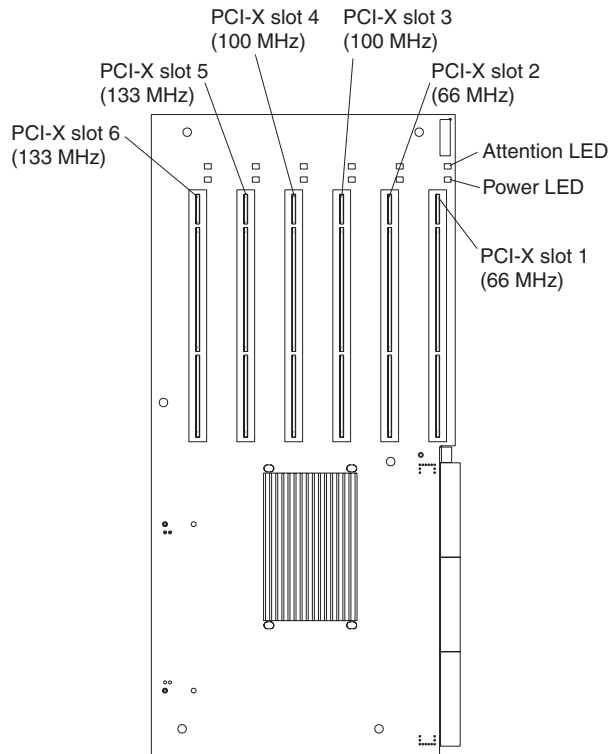

- Locate the documentation that comes with the adapter and follow those instructions in addition to the instructions in this section. If you need to change the switch settings or jumper settings on your adapter, follow the instructions that come with the adapter.
- Video adapters are not supported.
- Some full-length adapters have extension handles or brackets installed. Before installing the adapter, you must remove the extension handle or bracket.
- Your server supports six hot-plug 64-bit adapters in the expansion slots on the PCI-X board, as shown in the following table.

Bus	Slot	Supported adapter speed (MHz)
A	1	66
A	2	66
B	3	100 (133 if slot 4 is empty)
B	4	100 (133 if slot 3 is empty)
C	5	133
D	6	133

- You can install both PCI and PCI-X adapters on the same bus. However, if you install a PCI adapter and a PCI-X adapter on the same bus, the PCI-X features of the PCI-X adapter will be disabled, and the adapter will function as a PCI adapter.
- You can install PCI or PCI-X adapters of speeds faster than what is labeled for a particular PCI-X bus. For example, if you install two 133 MHz adapters into slots that are labeled as 100 MHz slots, the adapters will operate at 100 MHz.
- If you install a 33 MHz and a 66 MHz adapter on the same bus, the bus speed will match that of the slowest adapter.

- If a single 133 MHz adapter is installed on PCI-X bus B (slots 3 and 4) and the other slot on PCI-X bus B is empty, the adapter will operate at 133 MHz.
- Your server supports 3.3 V and universal adapters; it does not support 5.0 V adapters.
- The system scans PCI-X slots to assign system resources. The system attempts to start the first device found. The search order is: PCI-X slots 1, 2, 6, 5, 3, and 4. If an optional remote I/O enclosure is attached, the scan continues with PCI-X slots 11, 12, 9, 10, 7, 8, 17, 18, 15, 16, 13, and 14.

Complete the following steps to install an adapter:

1. Read the safety information beginning on page v and “Installation guidelines” on page 9.
2. Disable the Active PCI-X slots through your operating system before you insert or remove a PCI or PCI-X adapter.

Note: Some operating systems do not support the enabling and disabling of a PCI-X slot. If your operating system does not support this function, or if you are installing a non-hot-plug adapter, turn off the server and peripheral devices, and disconnect the power cords and all external devices from the back of the server before proceeding, if necessary.

3. Open the top cover.

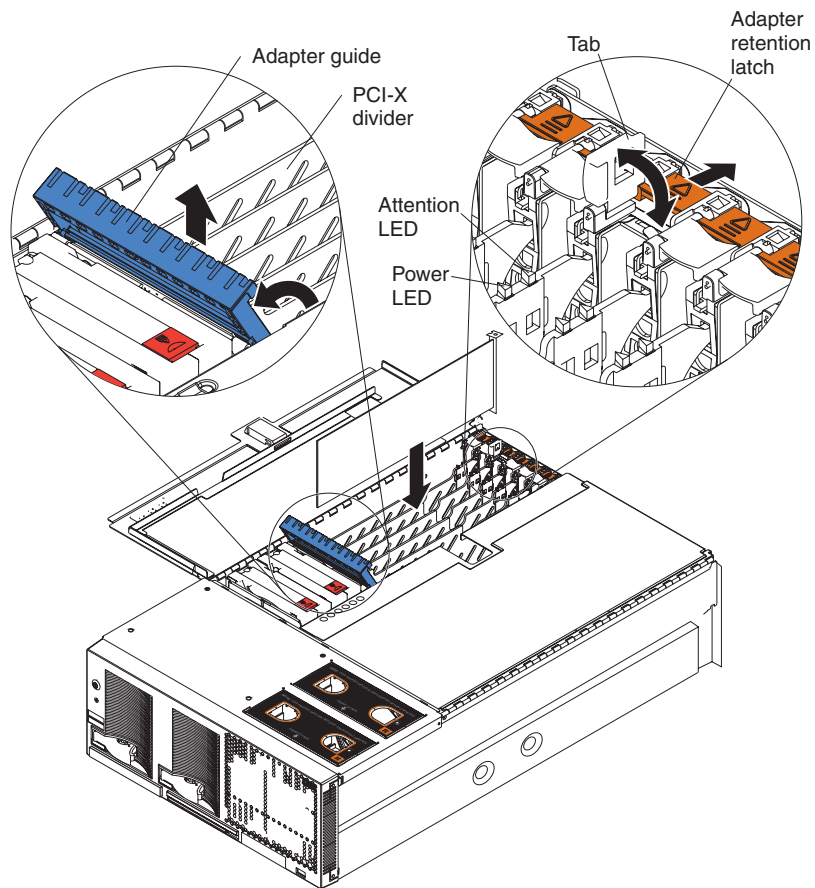

4. Follow the cabling instructions, if any, that come with the adapter. Route the adapter cables before you install the adapter.
5. Follow the instructions that come with the adapter to set jumpers or switches, if any.

6. Install the adapter:
 - a. If you are installing a full-length adapter, open the blue adapter guide by lifting the front edge, as shown in the illustration.
 - b. Carefully grasp the adapter by its top edge or upper corners, and align it with the connector on the PCI-X board.
 - c. Press the adapter *firmly* into the adapter connector.

Attention: When you install an adapter, be sure the adapter is correctly seated in the connector. Improperly seated adapters might cause damage to the PCI-X board or to the adapter.
 - d. Push down on the blue adapter guide to keep the adapter steady.
 - e. Close the tab; then, push down on the blue adapter-retention latch until it clicks into place, securing the adapter.
7. Connect the internal cables to the adapter.
8. If you have other options to install or remove, do so now.
9. Go to “Completing the installation” on page 22.

Installing and replacing a microprocessor and power module

The following notes describe the type of microprocessor that your server supports and other information that you must consider when installing and replacing a microprocessor:

- Your server supports up to four Intel Itanium 2 microprocessors.
- Read the documentation that comes with the microprocessor to determine whether you need to update the server system abstraction layer/extensible firmware interface (SAL/EFI) code. To download the most current level of SAL/EFI code for the server, go to <http://www.ibm.com/pc/support/> on the World Wide Web.
- (Optional) Obtain an SMP-capable operating system. For a list of supported operating systems, go to <http://www.ibm.com/pc/us/compat/>.
- You will need the following tools:
 - 2.5-mm hex (Allen) wrench (provided with the microprocessor option)
 - T15 Torx wrench (provided with the microprocessor option)
- To order additional microprocessor options, contact your IBM marketing representative or authorized reseller.
- Populate the microprocessor sockets in numeric order. Install the first microprocessor in microprocessor socket 1, the second microprocessor in microprocessor socket 2, and so on.
- The following illustrations show the locations of the microprocessor connectors on the processor board.

Note: The illustrations in this publication might differ slightly from your hardware.

Front side

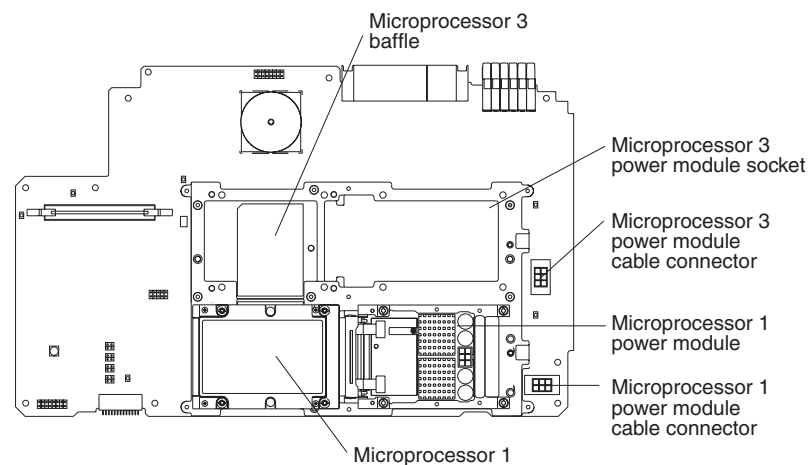

Reverse side

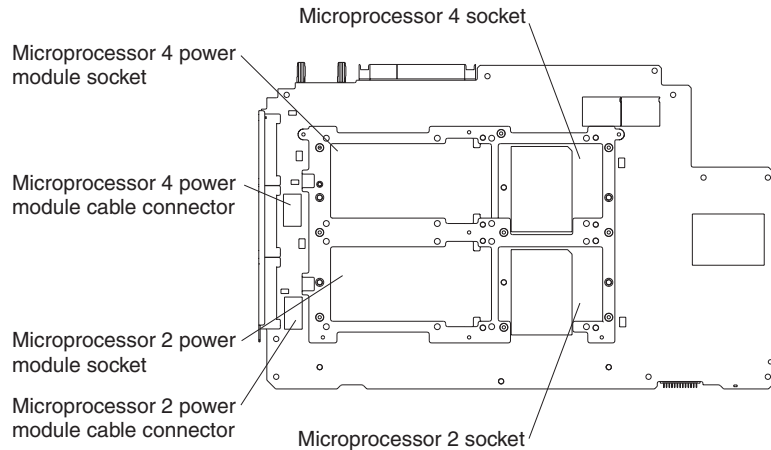

Important: To ensure proper server operation after you install replacement or additional microprocessors, install only microprocessors that have the same cache size and type, and the same clock speed. For a list of microprocessors supported by your server, go to the ServerProven list at <http://www.ibm.com/pc/us/compat/>.

Complete the following steps in the prescribed order to install and replace a microprocessor:

Attention: Failure to complete the following steps in the prescribed order might cause damage to the microprocessor pins and cause the microprocessor to fail.

1. Read the safety information beginning on page v and “Installation guidelines” on page 9.
2. Turn off the server and peripheral devices, and disconnect the power cords and all external cables, if necessary; then, open the cover.
3. Remove the memory-board assembly from the server:

Attention: When you handle static-sensitive devices, take precautions to avoid damage from static electricity. For details about handling these devices, see “Handling static-sensitive devices” on page 10.

- a. Pull up on the levers to detach the memory-board assembly.
- b. Carefully remove the memory-board assembly from the server and set it aside.

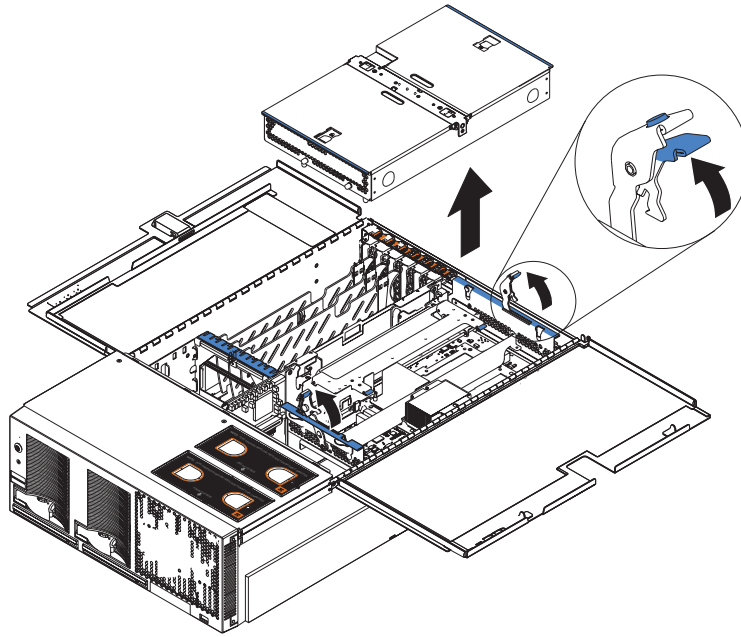

4. Remove the shipping thumbscrews from the right side of the server.
5. Lift the retention bracket from the server.

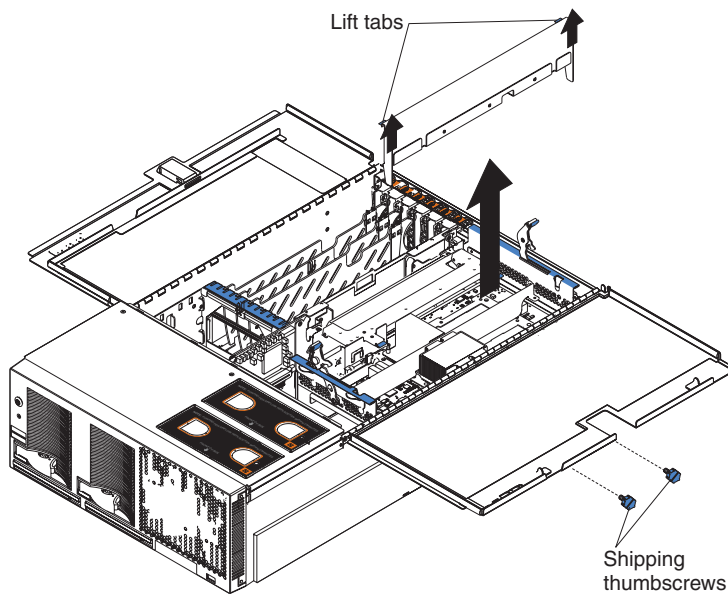

6. Remove the processor-board assembly from the server:

Attention: When you handle static-sensitive devices, take precautions to avoid damage from static electricity. For details about handling these devices, see “Handling static-sensitive devices” on page 10.

 - a. Press to unlock the levers securing the processor-board assembly and pull up on the levers to release the processor-board assembly.
 - b. Carefully remove the processor-board assembly from the server and place it on a flat, non-conductive, level surface.

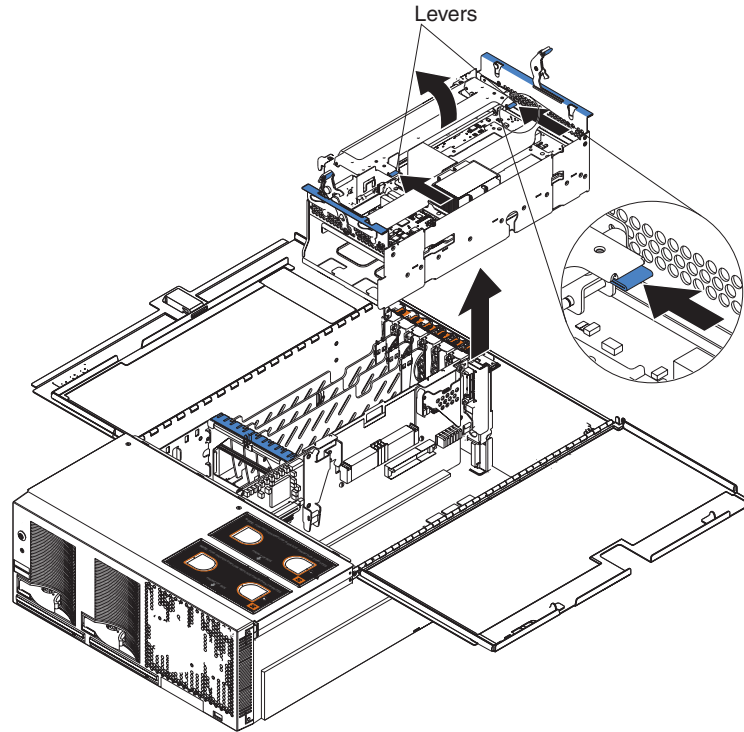

7. If you are installing a new microprocessor, go to step 8 on page 18; otherwise, continue:

Attention: Failure to complete the instructions in the prescribed order might cause damage to the microprocessor pins and cause the microprocessor to fail.

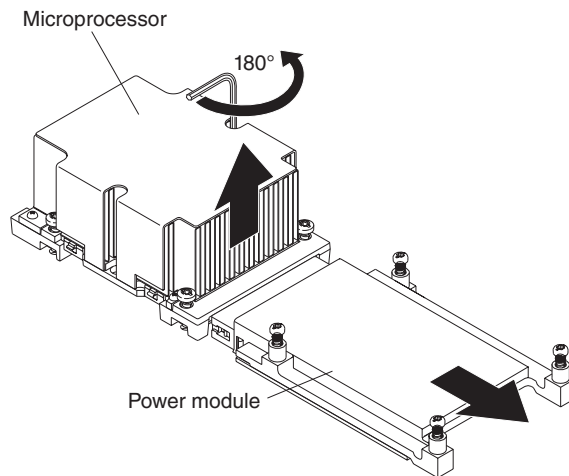

- a. Using the T-handled Torx wrench provided with the microprocessor option, completely loosen the power-module screws.
- b. Slide the power module from the microprocessor and remove the power module.
- c. Completely loosen the heat-sink screws.
- d. Use the hex wrench provided with the microprocessor option to open the socket lock and remove the microprocessor.

8. Install the microprocessor and power module:

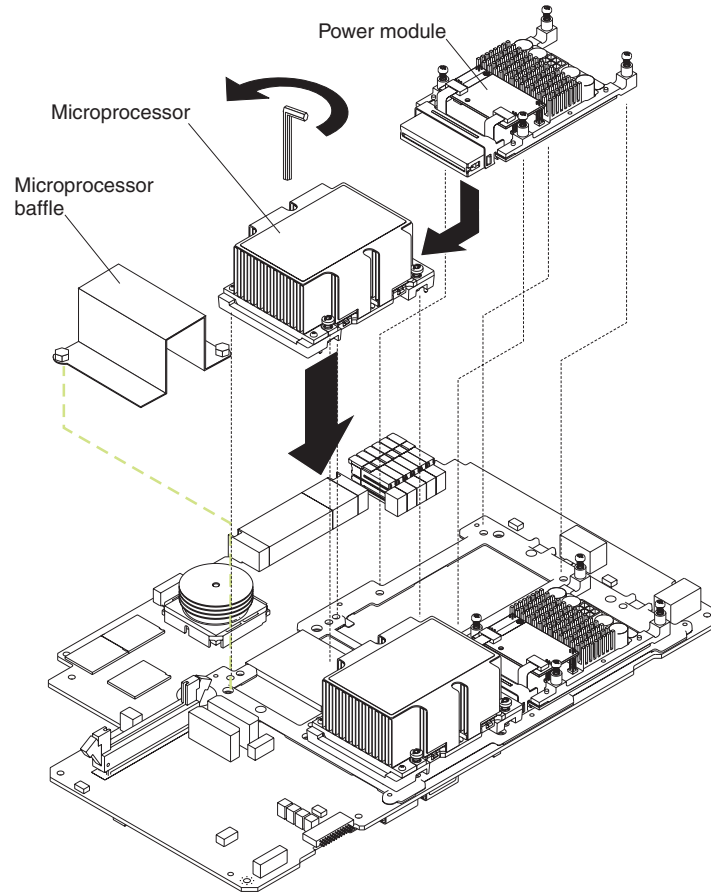

- a. Remove the microprocessor baffle from the microprocessor socket. Keep the microprocessor baffle for future use.
- b. Remove the protective tape covering the microprocessor socket, if present.
Attention: Inserting the microprocessor in a locked connector might damage the pins and cause the microprocessor to fail.
- c. Ensure that the socket lock is in the fully unlocked position to permit plugging in the microprocessor. Use the hex wrench provided with the microprocessor option to open the lock, if necessary.

Note: Examine the socket lock of an installed microprocessor to identify the locking flag in the locked position.

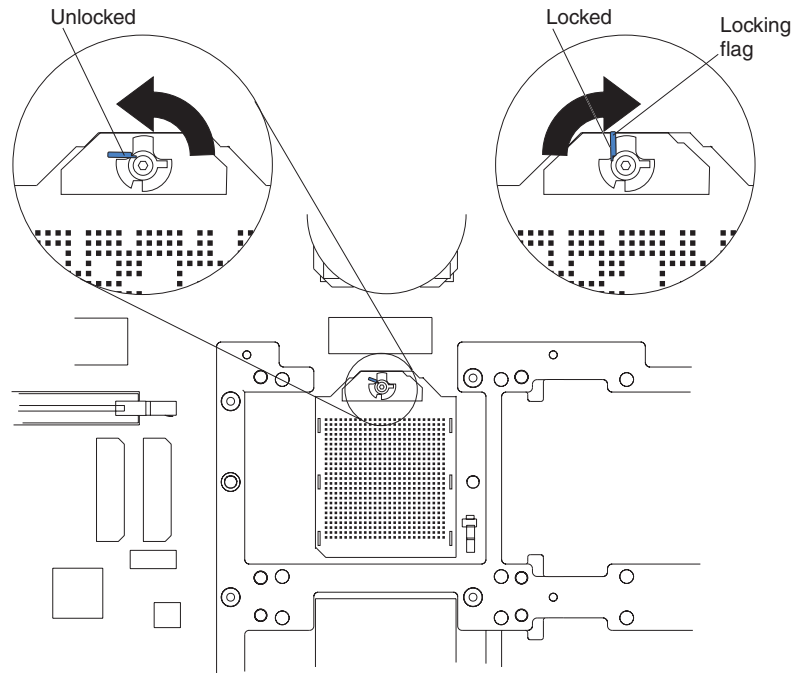

Attention: When you handle static-sensitive devices, take precautions to avoid damage from static electricity. For details about handling these devices, see “Handling static-sensitive devices” on page 10.

- d. Touch the static-protective package containing the microprocessor to any unpainted metal surface on the server. Then, remove the microprocessor and power module from the package.

Attention:

- 1) Forcing the microprocessor socket lock clockwise beyond the closed position might damage the socket locking mechanism. Before you install a microprocessor in the socket, use the hex wrench provided with the microprocessor option to close and open the socket lock to observe the locking flag in the closed position. Also, note the resistance of the locking mechanism in the closed position. When installing the microprocessor, do not force the socket lock clockwise beyond the closed position. If you need to see the microprocessor socket lock clearly, shine a flashlight over the microprocessor connector.
 - 2) Ensure that the microprocessor is aligned and seated correctly before you proceed. To avoid bending the pins on the microprocessor, do not use excessive force when pressing it into the socket.
- e. Insert the microprocessor gently into the connector. The microprocessor rests flat on the retention mechanism when properly seated.
 - f. Lock the socket lock, using the hex wrench provided with the microprocessor option.
 - g. Tighten the heat-sink screws to secure the microprocessor, using the T-handled Torx wrench provided with the microprocessor option.
 - h. Carefully slide the power module into the microprocessor.
 - i. Tighten the power-module screws to secure the power module.

- j. Plug the power-module cable into the power module and into the adjacent power-module cable connector.
9. Carefully install the processor-board assembly and retention bracket.
10. Carefully install the memory-board assembly.
11. If you have other options to install or remove, do so now.
12. Close the cover on the server; then, connect all external cables. For details, see “Completing the installation” on page 22.

Installing memory

The following notes describe the types of dual inline memory modules (DIMMs) that your server supports and other information that you must consider when installing DIMMs:

- Your xSeries 450 server supports 512 MB, 1 GB, and 2 GB DIMMs, for a maximum of 40 GB of system memory. Go to the ServerProven list at <http://www.ibm.com/pc/compat/> for a list of memory modules you can use with your server.
- Your server supports a maximum of only 20 DIMMs (10 per port) if any connector contains a 2 GB DIMM. Your server supports a maximum of 28 DIMMs (14 per port) if only 512 MB and 1 GB DIMMs are installed.
- Your server comes with a minimum of two 512 MB DIMMs, installed in slots 1 and 14. When installing additional DIMMs, you must install two DIMMs at a time, in the order shown in the following table to maintain performance.

Table 1. DIMM installation sequence

Pair	DIMM connectors (Port 1)	Pair	DIMM connectors (Port 2)
1	1 and 14	2	15 and 28
3	4 and 11	4	18 and 25
5	2 and 13	6	16 and 27
7	5 and 10	8	19 and 24
9	3 and 12	10	17 and 26
11	6 and 9	12	20 and 23
13	7 and 8	14	21 and 22

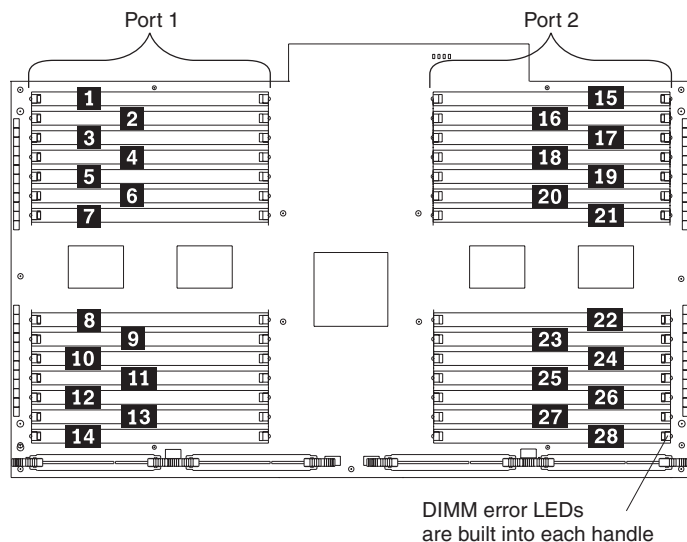

- Each DIMM in a pair must be of the same size and technology to ensure that the server will operate properly.
- When using memory mirroring, you must install two pairs of DIMMs at a time. The four DIMMs in each bank must be identical. The following table shows the pairs that are in each bank. See Table 1 on page 20 for the DIMM connector pair assignments.

Table 2. Memory mirroring DIMM installation sequence

Bank	DIMM pairs	Bank	DIMM pairs
1	1 and 2	5	9 and 10
2	3 and 4	6	11 and 12
3	5 and 6	7	13 and 14
4	7 and 8		

- When you install or remove DIMMs, the server configuration information changes. When you restart the server, the system displays a message indicating that the memory configuration has changed.

Complete the following steps to install a DIMM in your server:

1. Read the safety information beginning on page v and “Installation guidelines” on page 9.
2. Turn off the server and peripheral devices, and disconnect the power cords and all external cables, if necessary; then, open the cover.

Attention: When you handle static-sensitive devices, take precautions to avoid damage from static electricity. For details about handling these devices, see “Handling static-sensitive devices” on page 10.

3. Open the DIMM access door that covers the DIMM connector into which you will be installing the DIMM.

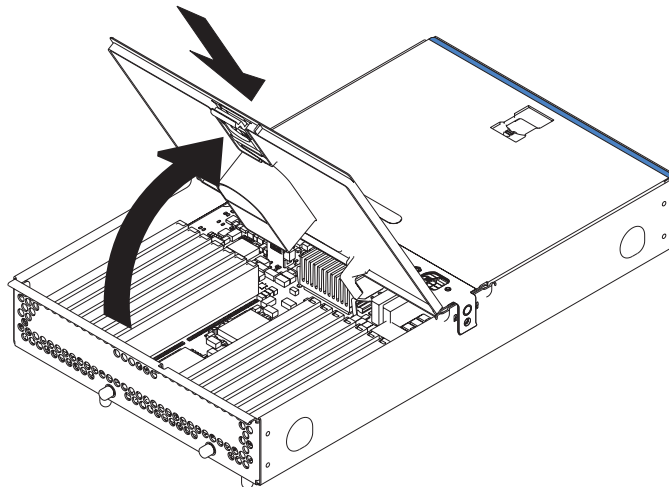

4. Install the new DIMM:
 - a. Open the retaining clip on each end of the DIMM connector.
 - b. Touch the static-protective package containing the DIMM to any unpainted metal surface on the server. Then, remove the DIMM from the package.

Attention: To avoid breaking the retaining clips or damaging the DIMM connectors, open and close the clips gently.
 - c. Turn the DIMM so that the DIMM keys align correctly with the slot.

- d. Insert the DIMM into the connector by aligning the edges of the DIMM with the slots at the ends of the DIMM connector. Firmly press the DIMM straight down into the connector by applying pressure on both ends of the DIMM simultaneously. The retaining clips snap into the locked position when the DIMM is firmly seated in the connector. If there is a gap between the DIMM and the retaining clips, the DIMM has not been correctly inserted; open the retaining clips, remove the DIMM, and then reinsert it.

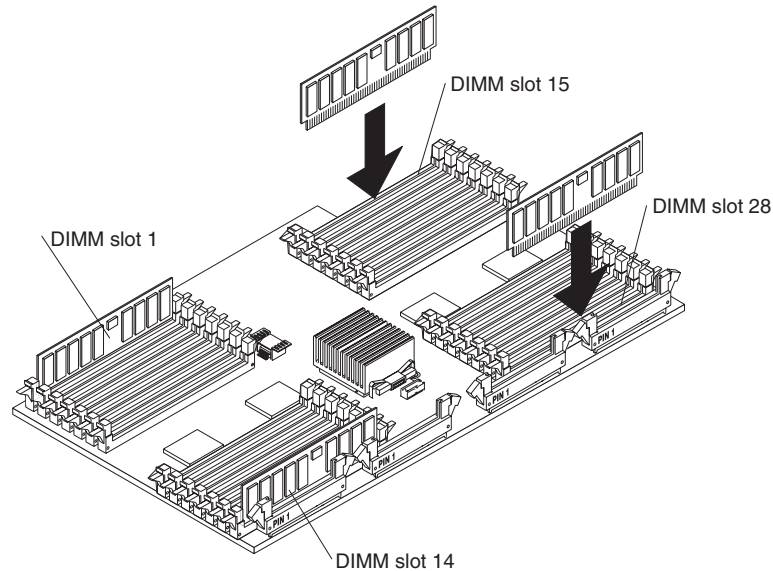

5. Close the DIMM access door.
6. If you have other options to install or remove, do so now.
7. Close the server cover. See “Completing the installation”.

Completing the installation

Complete the following steps to complete the installation:

1. Close the top cover.
2. Install the server in the rack cabinet. See the *Rack Installation Instructions* that come with your server for detailed information about how to install the server in a rack cabinet.

Attention:

- Install your server only in a rack cabinet with perforated doors.
 - Do not leave open space above or below an installed server in your rack cabinet. To help prevent damage to server components, always install a filler panel to cover the open space and to help ensure proper air circulation. See the documentation that comes with your rack cabinet for more information.
3. Connect the cables and power cords. See “Connecting the cables” for more information.

Connecting the cables

The following illustration shows the locations of the input and output connectors on your server.

Notes:

1. You must turn off the server before connecting cables to or disconnecting any cables from the server.

2. See the documentation that comes with your external devices for additional cabling instructions. It might be easier for you to route cables before you connect the devices to the server.
3. Cable identifiers are printed on the cables that come with your server and options. Use these identifiers to connect the cables to the correct connectors.

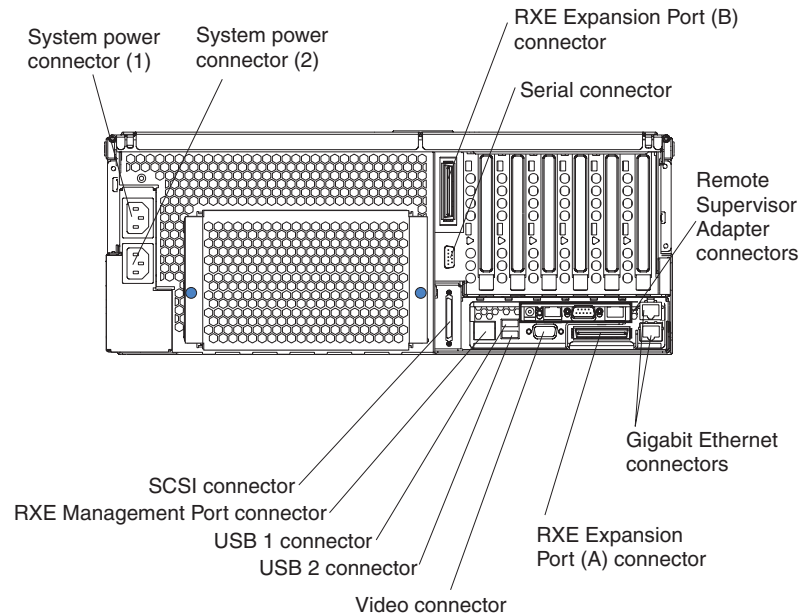

Note: If your server comes with an operating system installed, see the software documentation provided with your server for additional cabling instructions.

Power cabling

Your server comes with two power cords that can be connected to an external source, such as a properly grounded electrical outlet. Your server can also use two power cords that can be connected to a primary power unit inside the rack cabinet, such as a properly grounded power distribution unit or uninterruptible power supply.

Complete the following steps to connect the power cords:

1. Connect the power cords to the system power connectors on the rear of the server.

Notes:

- a. The power supplies are hot-swappable and redundant only at 200-240 V ac.
 - b. Both power supplies must be connected to the power source for operation at 100-127 V ac.
 - c. During normal operation, both power supplies must be installed for proper operation.
2. Connect the other end of the power cord to a properly grounded electrical outlet or a power distribution unit inside the rack cabinet.

Note: Connecting the power cords into an electrical outlet might cause the server to start automatically. This is an acceptable action.

3. See “Turning on the server” on page 30 for detailed information about turning on the server.

SCSI cabling

Your server has one SCSI connector on the back of the server. Use this connector to connect the server to an optional SCSI device such as a storage enclosure. For information about how to connect the option to your server, see the documentation that comes with the option.

USB cabling

Your server has three USB connectors, one on the front and two on the back of the server. Use these connectors to connect the server to an optional USB device. For information about how to connect the option to your server, see the documentation that comes with the option.

Serial cabling

There is one serial connector on the back of the server. Use this connector to connect the server to a modem or other optional serial device. For information about how to connect this option to your server, see the documentation that comes with the option.

Video cabling

There is one video connector on the back of the server. Use this connector to connect the server to a monitor or optional console switch. For information about how to connect this option to your server, see the documentation that comes with the option.

Gigabit Ethernet cabling

There are two Ethernet connectors on the back of the server. Use these connectors to connect the server to a LAN.

Note: A third Ethernet connector is on the Remote Supervisor Adapter. This connector is used for specific supervisory functions and should not be confused with the Gigabit Ethernet connectors.

RXE management cabling

There is one RXE Management Port connector on the back of the server. Use this connector to attach the server to the management port of an optional remote I/O enclosure. PCI-X slots in a remote I/O enclosure are managed through this port.

Notes:

1. For additional information about cabling the server to the remote I/O enclosure and how the server and remote I/O enclosure work together, see the documentation that comes with the enclosure.
2. Use the following instructions regardless of whether your remote I/O enclosure has one or two expansion kits installed.

Complete the following steps to connect the server RXE Management Port connector to a remote I/O enclosure:

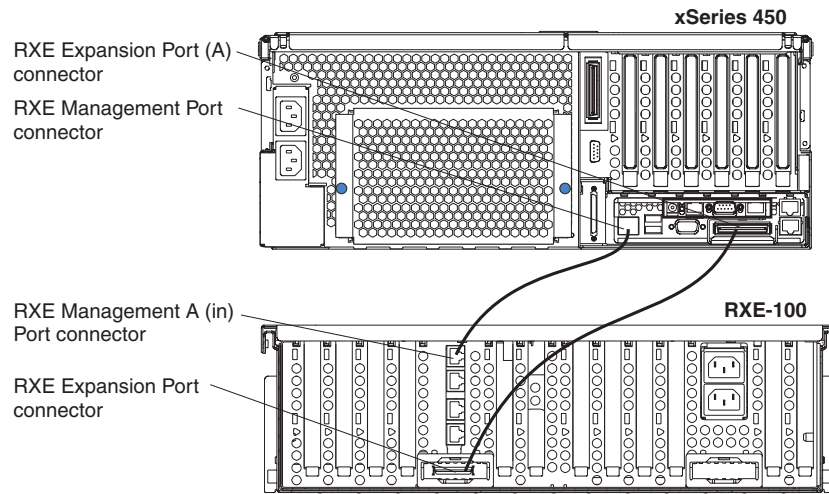

1. Using an RXE management cable, connect one end of the cable to the RXE Management Port connector on the server.
2. Connect the opposite end of the cable to the RXE Management A (in) Port connector on the remote I/O enclosure.

RXE expansion cabling

There are two RXE Expansion Port connectors on the rear of the server. Use these connectors to connect the server to a remote I/O enclosure and to expand the number of PCI-X slots that are available for use by the server. For additional information about cabling the RXE Expansion Port connectors, see the documentation that comes with the remote I/O enclosure.

Complete the following steps to cable the server to a remote I/O enclosure with one expansion kit installed.

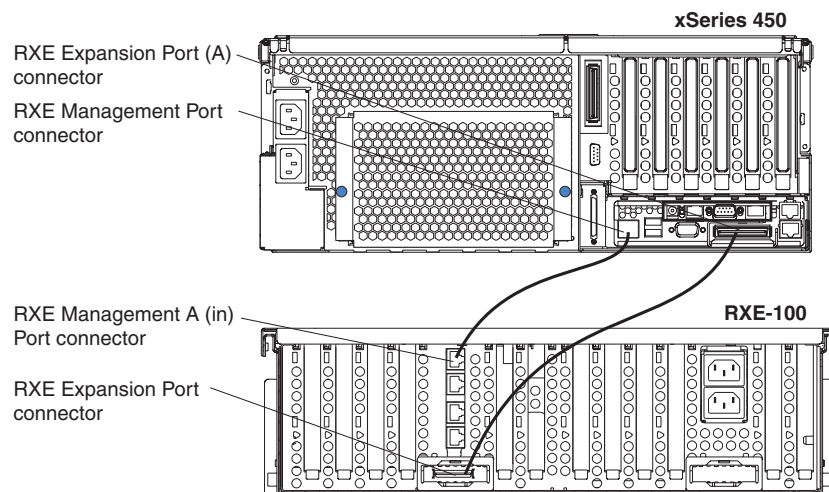

1. Using an RXE expansion cable, connect one end of the cable to the RXE Expansion Port (A) connector on the server.
2. Connect the opposite end of the cable to an RXE Expansion Port connector on the remote I/O enclosure.

Complete the following steps to cable the server to a remote I/O enclosure with two expansion kits installed.

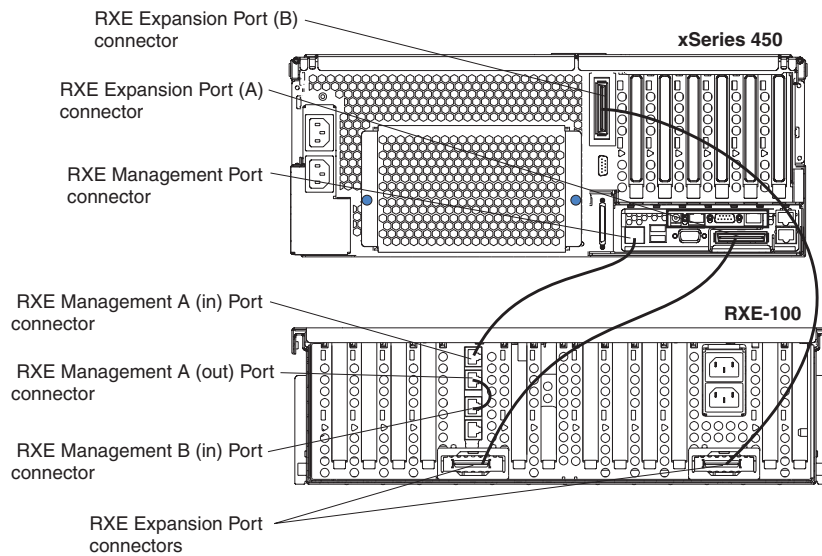

1. Using an RXE expansion cable, connect one end of the cable to the RXE Expansion Port (A) connector on the server.
2. Connect the opposite end of the cable to a RXE Expansion Port connector on the remote I/O enclosure.
3. Using an RXE expansion cable, connect one end of the cable to the RXE Expansion Port (B) connector on the server.
4. Connect the opposite end of the cable to a RXE Expansion Port connector on the remote I/O enclosure.
5. Using a jumper cable, connect the RXE Management A (out) Port on the remote I/O enclosure to the RXE Management B (in) Port on the remote I/O enclosure.

Remote Supervisor Adapter cabling

Your server comes with a Remote Supervisor Adapter. For information about cabling the Remote Supervisor Adapter connectors, see the *User's Guide* on the IBM *xSeries Documentation CD*.

Chapter 3. Server controls, LEDs, and power

This section describes the controls and light-emitting diodes (LEDs) on the front and rear of your server. It also describes how to turn the server on and off.

Front view

The following illustration shows the controls, LEDs, and connectors on the front of the server.

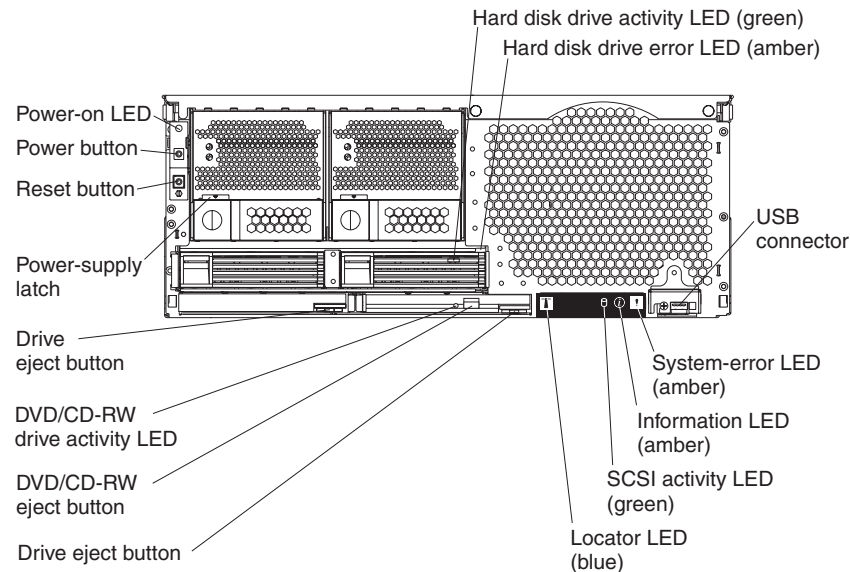

Power-on LED: This green LED turns on and stays on when you turn on your server, and it flashes when the server is in Standby mode.

Hard disk drive activity LED: When this green LED is lit, it indicates that the hard disk drive is in use.

Hard disk drive error LED: On some server models, each hot-swap hard disk drive has an error LED. The interpretation of a flashing error LED depends on the SCSI controller connected to the hot-swap drive. When the drive is connected to the integrated SCSI controller with RAID capabilities, a flashing error LED indicates that the drive is a secondary drive in a mirrored pair and the drive is being synchronized.

USB connector: Connect a USB device to this connector.

System-error LED: When this amber LED is lit, it indicates a system error has occurred.

Information LED: When this amber LED is lit, it indicates that information about a system error has been entered in the System Error log.

SCSI activity LED: When this green LED is lit, it indicates that there is activity on the SCSI bus.

Locator LED: This blue LED is used to help you locate other devices connected to the server. When this LED flashes, it indicates that POST is in progress.

Drive eject button: Press this button to release the drive from the server.

DVD/CD-RW eject button: Press this button to release a DVD or CD from the drive.

DVD/CD-RW drive activity LED: When this LED is lit, it indicates that the DVD/CD-RW drive is in use.

Drive eject button: Press this button to release a drive from the server.

Power-supply latch: This latch secures the power supply in place.

Reset button: Press this button to reset the server and run the power-on self-test (POST). You might need to use a pen or the end of a straightened paper clip to press the button.

Power button: Press this button to manually turn the server on or off.

Rear view

The following illustration shows the connectors and LEDs on the rear of the server.

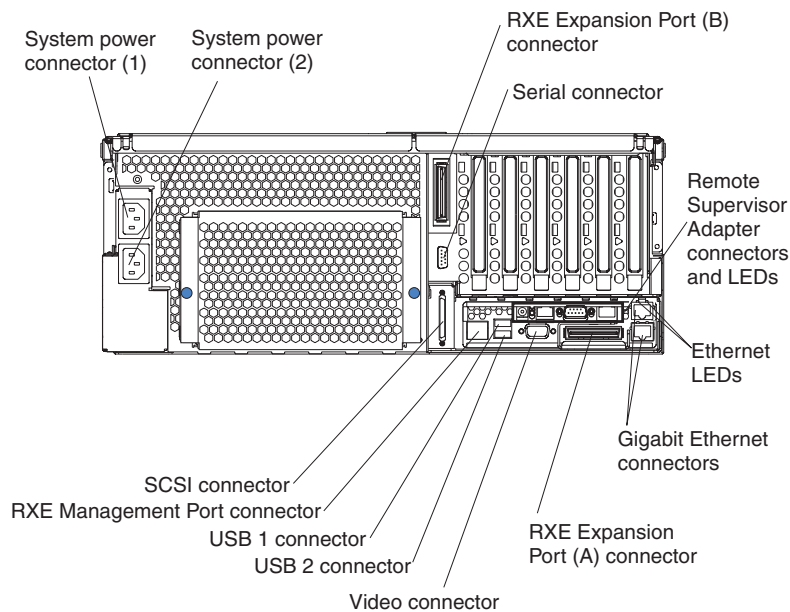

System power connectors (1 and 2): Connect the power cords to these two connectors to provide power to the server.

RXE Expansion Port (B) connector: Connect a remote I/O enclosure to this connector.

Serial connector: Connect the signal cable for a modem or other serial device to this connector.

Remote Supervisor Adapter connectors and LEDs: This group of connectors and LEDs located on the back of the server are used for system management

information and control.

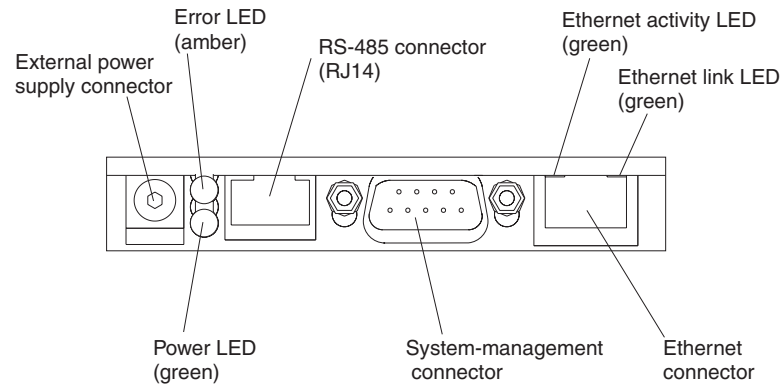

- **External power supply connector:** This connector is not supported on this server.
- **Error LED:** When this amber LED is lit, it indicates an error on the Remote Supervisor Adapter.
- **ASM RS-485 connector (RJ-14):** Connect signal cables for managing expansion module resources to this connector.
- **Ethernet activity LED:** When this green LED flashes, it indicates that there is activity on the Ethernet LAN.
- **Ethernet link LED:** When this green LED is lit, it indicates that there is an active link connection.
- **Ethernet connection:** Connect Ethernet signal cables to this connector.
- **System-management connector:** Connect signal cables for modems or other serial devices to this connector.
- **Power LED:** The green power LED indicates the status of the power connection.

Ethernet LEDs: When these LEDs are amber it indicates that there is activity on the Ethernet LAN. When these LEDs are green it indicates that there is an active link connection on the Gigabit Ethernet controller.

Gigabit Ethernet connectors: Use these connectors to connect the server to a network.

RXE Expansion Port (A) connector: Connect a remote I/O enclosure to this connector.

Video connector: Connect a monitor to this connector.

USB 2 connector: Connect a USB device to this connector.

USB 1 connector: Connect a USB device to this connector.

RXE Management Port connector: Connect a remote I/O enclosure to this connector.

SCSI connector: Connect a SCSI device to this connector.

Server power features

When the server is connected to an ac power source but is not turned on, the operating system does not run, and all core logic except for the service processor is shut down; however, the server can respond to requests from the service processor, such as a remote request to turn on the server. The power-on LED flashes to indicate that the server is connected to ac power but is not turned on.

Turning on the server

Approximately 20 seconds after the server is connected to ac power, the power-control button becomes active, and you can turn on the server and start the operating system by pressing the power-control button. The server can also be turned on in any of the following ways:

- If a power failure occurs while the server is turned on, the server will restart automatically when power is restored.
- If ac power is present, the server can be turned on from the Remote Supervisor Adapter user interface.
- The Wake on LAN feature can turn on the server.

Notes:

1. The power supplies are hot-swappable and redundant only at 200-240 V ac.
2. Both power supplies must be connected to the power source for operation at 100-127 V ac.
3. During normal operation, both power supplies must be installed for proper operation.
4. While the server is powering up, the power-on LED on the front of the server is lit. When the server is connected to ac power but is not turned on, the power-on LED on the front of the server flashes.

Turning off the server

When you turn off the server and leave it connected to ac power, the server can respond to requests from the service processor, such as a remote request to turn on the server. To remove all power from the server, you must disconnect it from the power source.

Some operating systems require an orderly shutdown before you turn off the server. See your operating-system documentation for information about shutting down the operating system.

Statement 5:



CAUTION:

The power control button on the device and the power switch on the power supply do not turn off the electrical current supplied to the device. The device also might have more than one power cord. To remove all electrical current from the device, ensure that all power cords are disconnected from the power source.

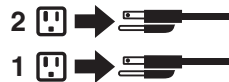

The server can be turned off in any of the following ways:

- You can turn off the server from the operating system, if your operating system supports this feature. After an orderly shutdown of the operating system, the server will be turned off automatically.
- You can press the power-control button to start an orderly shutdown of the operating system and turn off the server, if your operating system supports this feature.
- If the operating system stops functioning, you can press and hold the power-control button for more than 4 seconds to turn off the server.
- If the server is connected to an Advanced System Management interconnect network, the server can be turned off using the Remote Supervisor Adapter user interface.

Notes:

1. You might need to press and hold the power-control button for more than 4 seconds to cause an immediate shutdown of the server. You can use this feature if the operating system stops functioning.
2. If you disconnect the server from the power source, wait approximately 15 seconds for the server to stop running before you open the cover. Watch for the power-on LED on the front of the server to stop flashing.

Chapter 4. Configuring your server

The Extensible Firmware Interface (EFI) Boot Manager program controls the startup environment. After you turn on the server, this program offers you a choice of startup options. For example, you can start to an operating system located on the network or media, or to the EFI Boot Maintenance Manager main menu.

In addition to the EFI Boot Manager program, you can use the following configuration programs to customize the server hardware:

- Configuration/Setup Utility
- LSI Logic Configuration Utility
- Remote Supervisor Adapter configuration process

Using the Extensible Firmware Interface (EFI) Boot Manager program

From the EFI Boot Maintenance Manager main menu, the EFI Boot Manager program enables you to configure a variety of startup options. You can use it to:

- Set the startup options
- Define the startup option to use for the next restart
- Set the automatic restart feature

Complete the following steps to start the EFI Boot Manager program and access the EFI Boot Maintenance Manager main menu:

1. Turn on the server and watch the monitor screen.
2. From the EFI Boot Manager startup options, select the EFI Boot Maintenance Manager main menu.
3. Follow the instructions that appear on the screen.

For more information about using the EFI Boot Manager program, see the section on the EFI Boot Manager program in the *User's Guide* on the IBM xSeries Documentation CD.

Using the Configuration/Setup Utility program

Configuration/Setup is a menu-driven utility that is part of the SAL/EFI code that comes with your server. You can use it to:

- Configure system devices and ports
- Set the date and time
- Set passwords and security settings

Complete the following steps to start the Configuration/Setup Utility program:

1. Turn on the server and watch the monitor screen.
2. From the EFI Boot Manager startup options, select the Configuration/Setup Utility program.
3. Follow the instructions that appear on the screen.

For more information about using the Configuration/Setup Utility program, see the section on the Configuration/Setup Utility program in the *User's Guide* on the IBM xSeries Documentation CD.

Using the LSI Logic Configuration Utility

The LSI Logic Configuration program is a built-in, menu-driven configuration utility program. You can use it to:

- Configure a redundant array of independent disks (RAID)
- Perform a low-level format on a hard disk
- Set the SCSI device scan order
- Set the SCSI ID for a controller

Notes:

1. The integrated SCSI controller with RAID capabilities in your server supports RAID level 1. However, you might have to download an updated release of the system abstraction layer/extensible firmware interface (SAL/EFI) code for the firmware and device driver to provide support for RAID level 1. To download the SAL/EFI code, when it is available, go to <http://www.ibm.com/pc/support/> on the World Wide Web.
2. You must configure your SCSI controller with RAID capabilities *before* you install your operating system to use RAID level 1.
3. You can only connect the internal hard disk drives to the integrated SCSI controller with RAID capabilities.
4. If you install a different type of RAID controller in your server, use the configuration method supplied with the RAID controller to view or change SCSI settings for attached devices.

Complete the following steps to start the LSI Logic Configuration Utility program:

1. Turn on the server and watch the monitor screen.
2. From the EFI Boot Manager startup options, select EFI Shell.
3. Type `drivers -b` to display the device driver handle identifiers. Note the device driver handle identifier in the far left column for the LSI Logic Ultra320 SCSI device driver.
4. Type `drvcfg drv` to display the controller identifiers. Note the controller identifier for the LSI Logic Ultra320 SCSI device driver.
5. Type `drvcfg drv ctrl -s.` to run the utility (where *drv* is the device driver handle identifier and *ctrl* is the controller identifier).
6. Type `drvcfg /?` for help.

Using the Remote Supervisor Adapter

The Remote Supervisor Adapter is one of the products in the Advanced System Management (ASM) family. It provides around-the-clock remote access and system management of your server and supports the following features:

- Remote management regardless of the status of the server
- Remote control of hardware and operating systems
- Web-based management with standard Web browsers (no other software is required)
- Text-based user interface terminal access

The Remote Supervisor Adapter provides the following specific features:

- Continuous health monitoring and control
- Advanced Predictive Failure Analysis[®] (PFA) alerts
- Configurable automatic notification and alerts

- Remote access through Ethernet, point-to-point protocol (PPP) connection, serial port, and ASM interconnect peer-to-peer network
- Simple Network Management Protocol (SNMP)
- Domain Name System (DNS) and Dynamic Host Configuration Protocol (DHCP) support
- Remote power control
- Remote firmware update and access to critical server settings
- Independent power, which enables around-the-clock access to the server even when the server power is off
- E-mail alerts
- Event logs that are timestamped, saved by a battery power unit, and can be attached to e-mail alerts
- Redirection of the server graphical or text console
- Access to vital product data (VPD)
- Alphanumeric or numeric pager alerts

For information about cabling, configuring, and using the Remote Supervisor Adapter to manage the server remotely, see the *User's Guide* and the *Remote Supervisor Adapter User's Guide* on the IBM xSeries Documentation CD.

Chapter 5. Solving problems

This section provides basic troubleshooting information to help you solve some common problems that might occur while you are setting up your server.

If you cannot locate and correct the problem using the information in this section, see the *Hardware Maintenance Manual and Troubleshooting Guide* on the IBM *xSeries Documentation CD* for more information.

Diagnostic tools overview

The following tools are available to help you identify and solve hardware-related problems:

- **POST error codes**

The power-on self-test error codes indicate the status of POST. See “POST error codes” and the *Hardware Maintenance Manual and Troubleshooting Guide* on the IBM *xSeries Documentation CD* for more information.

- **Light Path Diagnostics feature**

Use the Light Path Diagnostics feature to identify system errors quickly. See “Light Path Diagnostics feature overview” on page 38 for more information.

- **Troubleshooting charts**

These charts list problem symptoms and steps to correct the problems. See the “Troubleshooting charts” on page 41 for more information.

- **Diagnostic programs and error messages**

The system diagnostic programs are provided in ROM. These programs test the major components of your server. See the *Hardware Maintenance Manual and Troubleshooting Guide* on the IBM *xSeries Documentation CD* for more information.

POST error codes

The following table provides an abbreviated list of the error codes that might appear in the System Error Log during POST. See the *Hardware Maintenance Manual and Troubleshooting Guide* on the IBM *xSeries Documentation CD* for more information about the POST error codes.

Table 3. Abbreviated list of POST error messages

POST message	Failing device or problem found	Suggested action
229	External cache on the processor board	Have the system serviced.
1200	Processor board	Check that the processor board is properly seated. If so, have the system serviced.
201	Memory board	Check that the memory board is properly seated. If so, have the system serviced.
16xx	I/O board	Check that the I/O board is properly seated. If so, have the system serviced.
175 or 188	Electrically erasable programmable ROM (EEPROM) on I/O board	Update the system SAL/EFI code.
1813	SCSI controller	Have the system serviced.
18xx	PCI board	Check that the PCI adapters are properly seated.

Light Path Diagnostics feature overview

If the system-error LED on the operator information panel is lit, one or more LEDs inside the server might be lit. Use the Light Path Diagnostics panel to identify the type of error that occurred.

To acknowledge a system error but not take immediate action, press the REMIND button and place the Light Path Diagnostics feature in Remind mode. The system-error LED flashes in Remind mode. If a new failure occurs, the system-error LED is lit again.

The following illustration shows the LEDs on the diagnostics panel. See “Identifying problems using the Light Path Diagnostics feature” for information about identifying problems using these LEDs.

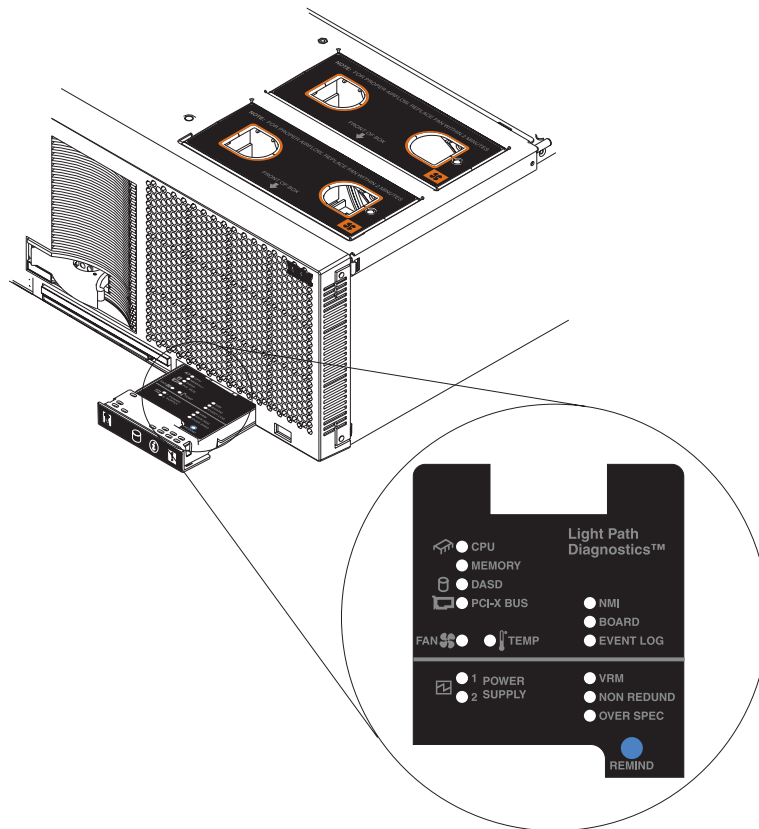

Identifying problems using the Light Path Diagnostics feature

This section provides instructions for identifying problems that might arise during installation using the Light Path Diagnostics feature.

The diagnostics panel

The diagnostics panel should be the first place you look for help in identifying problems. If a system error occurs, the system-error LED on the front of this panel is lit. Press the front of the panel to open it, and look for any lit LEDs. These lit LEDs can help you identify the possible cause of the error. Make a note of any LEDs that are lit, and then close the panel.

LEDs on the top of the server

Another location you can use to find an error is on the top of the server. If the BOARD LED on the diagnostics panel is lit, pull the server out and view the top

cover. In the center of the top cover is a set of six LEDs and the system service labels. Follow the instructions, if any, on the system service labels.

LEDs on the system boards

To locate the actual component that caused the error, you must locate the lit LED next to that component.

For example:

A system error has occurred, and you have noted that the CPU LED is lit on the diagnostics panel. Referring to the LEDs on the top cover, you see that LED 2 is lit. Follow the instructions in the *Option Installation Guide* on the IBM xSeries *Documentation* CD to remove the processor board. Located on the processor board is the light-path capacitor switch. Press and hold the switch until you locate the lit LED next to the defective microprocessor. Follow the instructions in the *Option Installation Guide* to remove and replace the microprocessor.

Light Path Diagnostics table

The system-error LED on the operator information panel is lit when certain system errors occur. If the system-error LED on your server is lit, use the following table to help determine the cause of the error and the action you should take.

Table 4. Light Path Diagnostics

Lit LED on diagnostics panel	Cause	Action
None	An error has occurred and cannot be isolated, or the ASM processor has failed.	An error has occurred that is not represented by a Light Path Diagnostics LED. Check the system error log for more information about the error.
CPU	One of the microprocessors has failed.	<ol style="list-style-type: none"> 1. Check the microprocessor failure LEDs on the system board. Note: If you have installed more than one microprocessor, check the reverse side of the processor board for lit microprocessor failure LEDs. 2. If a microprocessor error LED is lit, make sure the microprocessor is installed correctly. (See the <i>Option Installation Guide</i> on the IBM xSeries <i>Documentation</i> CD for installation instructions). <p>If the problem remains, have the system serviced.</p>
MEMORY	A memory error occurred.	<ol style="list-style-type: none"> 1. Check the DIMM failure LEDs on the memory board. 2. Replace the DIMM indicated by the lit DIMM failure LED.
DASD	A hard disk drive error occurred.	Check the LEDs on the hard disk drives and replace the indicated drive.

Table 4. Light Path Diagnostics (continued)

Lit LED on diagnostics panel	Cause	Action
PCI-X BUS	An error occurred on a PCI bus.	<ol style="list-style-type: none"> 1. Check the error log for additional information. 2. If you cannot isolate the failing adapter from the information in the error log, try to determine the failing adapter by removing one adapter at a time from the failing PCI-X bus and restarting the server after each adapter is removed. <p>If the problem remains, have the system serviced.</p>
FAN	A fan has failed or is operating too slowly. Note: A failing fan can also cause the TEMP LED to be lit.	Check the LEDs on the fans and replace the indicated fan.
TEMP	The system temperature has exceeded a threshold level.	<ol style="list-style-type: none"> 1. Check to see if a fan has failed. If it has, replace the fan. 2. Make sure air vents are not blocked. 3. Make sure the room temperature is not too hot. (See “Features and specifications” on page 4 for temperature information.) <p>If the problem remains, have the system serviced.</p>
NMI	A machine check abort error has occurred.	Check the error log to identify the condition.
BOARD	A system board has failed.	<ol style="list-style-type: none"> 1. Remove ac power from the server; then, reconnect the server to ac power and restart the server. 2. Check the LEDs on the top of the server. <p>If the problem remains, have the system serviced.</p>
EVENT LOG	A system warning has occurred.	Check the error log to identify the condition.
PS1 and PS2	The indicated power supply has failed.	<p>Replace the power supply.</p> <p>If the problem remains, have the system serviced.</p>
VRM	One of the VRMs has failed.	<ol style="list-style-type: none"> 1. Remove ac power from the server; then, reconnect the server to ac power and restart the server. 2. Check the error log for additional information. <p>If the problem remains, have the system serviced.</p>
NON REDUND	The power supplies are no longer redundant or a power supply has failed.	<ol style="list-style-type: none"> 1. Check to see if a power supply has failed. If it has, replace the power supply. 2. Use a higher voltage ac power source, or remove optional devices from the server until redundancy is restored, if redundancy is required.

Table 4. Light Path Diagnostics (continued)

Lit LED on diagnostics panel	Cause	Action
OVER SPEC	The power supplies are using more power than the maximum rating.	Replace the failed power supply, or remove optional devices from the server.

Troubleshooting charts

You can use the troubleshooting charts in this section to find solutions to problems that have definite symptoms.

Attention: If diagnostic error messages appear that are not listed in the following tables, make sure that your system has the latest level of SAL/EFI code installed.

See the *Hardware Maintenance Manual and Troubleshooting Guide* on the IBM *xSeries Documentation CD* for more detailed information about testing the server. If you have run the diagnostic tests or if running the tests does not reveal the problem, call for service.

If you have just added new software or a new option and your server is not working, complete the following steps before using the troubleshooting charts:

1. Remove the software or device that you just added.
2. Run the diagnostic tests to determine whether your server is running correctly.
3. Reinstall the new software or new device.

Table 5. Troubleshooting charts

Device	Suggested action
DVD/CD-RW drive	Verify that the device is inserted in the right-side bay and is seated correctly in the bay.
DVD/CD-RW drive is not recognized.	If the problem remains, call for service.
Other devices	Call for service.
Problems such as broken cover locks or indicator LEDs not working.	
Intermittent problems	Verify that: <ol style="list-style-type: none"> 1. All cables and cords are connected securely to the rear of the server and attached options. 2. When the server is turned on, air is flowing from the rear of the server at the fan grille. If there is no air flow, the fan is not working. This causes the server to overheat and shut down. 3. Ensure that the SCSI bus and devices are configured correctly and that the last external device in each SCSI chain is terminated correctly. 4. Check the system-error LED on the front of the server. See "Light Path Diagnostics feature overview" on page 38 for more information.
A problem occurs only occasionally and is difficult to detect.	If the items above are correct, call for service.
USB Keyboard, mouse, or pointing-device	<ol style="list-style-type: none"> 1. Make sure that the keyboard USB cable is properly connected to the server. 2. Try using another keyboard.
All or some keys on the keyboard do not work.	If the problem remains, call for service.

Table 5. Troubleshooting charts (continued)

Device	Suggested action
The USB mouse or USB pointing device does not work.	<ol style="list-style-type: none"> 1. Make sure that the mouse or pointing-device USB cable is properly connected to the server. 2. Try using another mouse or pointing device. <p>If the problem remains, call for service.</p>
Memory	Verify that:
The amount of memory displayed is less than the amount of memory installed.	<ol style="list-style-type: none"> 1. The memory modules are seated properly. 2. You have installed the correct type of memory. 3. All banks of memory on the DIMMs are enabled. The server might have automatically disabled a DIMM bank if it detected a problem. 4. Memory mirroring is disabled. <p>If the items above are correct and the screen remains blank, call for service.</p>
Monitor	Verify that you installed the necessary device drivers for the applications.
The monitor works when you turn on the server, but goes blank when you start some application programs.	<p>Some IBM monitors have their own self-tests. If you suspect a problem with your monitor, see the information that comes with the monitor for adjusting and testing instructions.</p> <p>If you still cannot find the problem, call for service.</p>
The screen is blank.	<p>Verify that:</p> <ol style="list-style-type: none"> 1. The server power cord is plugged into the server and an ac power source. 2. The monitor cables are connected properly. 3. The monitor is turned on and the brightness and contrast controls are adjusted correctly. <p>Note: During startup it might appear that the server is unresponsive for an unusual length of time (30 seconds to several minutes). The Locator LED on the front of the server flashes during startup and indicates that POST is in progress.</p> <p>If the items above are correct and the screen remains blank, call for service.</p>
Only the cursor appears.	Call for service.
Wavy, unreadable, rolling, distorted screen, or screen jitter.	<p>If the monitor self-tests show the monitor is working properly, consider the location of the monitor. Magnetic fields around other devices (such as transformers, appliances, fluorescent lights, and other monitors) can cause screen jitter or wavy, unreadable, rolling, or distorted screen images. If this happens, turn off the monitor. (Moving a color monitor while it is turned on might cause screen discoloration.) Then move the device and the monitor at least 305 mm (12 in.) apart. Turn on the monitor.</p> <p>Notes:</p> <ol style="list-style-type: none"> 1. Non-IBM monitor cables might cause unpredictable problems. 2. An enhanced monitor cable with additional shielding is available for the 9521 and 9527 monitors. For information about the enhanced monitor cable, contact your IBM reseller or IBM marketing representative. <p>If the problem remains, call for service.</p>
Wrong characters appear on the screen.	<p>If the wrong language is displayed, update the SAL/EFI code with the correct language.</p> <p>If the problem remains, call for service.</p>

Table 5. Troubleshooting charts (continued)

Device	Suggested action
Option	Verify that:
An IBM option that was just installed does not work.	<ol style="list-style-type: none"> 1. The option is designed for the server. See the “Server Support” flowchart on the inside of the front cover for information about obtaining ServerProven compatibility information from the World Wide Web. 2. You followed the installation instructions that came with the option. 3. You have not loosened any other installed options or cables. 4. You updated the configuration information in the Configuration/Setup Utility program. Whenever memory or an option is changed, you must update the configuration. <p>If the problem remains, call for service.</p>
An IBM option that used to work does not work now.	<p>Verify that all of the option hardware and cable connections are secure.</p> <p>If the option comes with its own test instructions, use those instructions to test the option.</p> <p>If the failing option is a SCSI option, verify that:</p> <ol style="list-style-type: none"> 1. The cables for all external SCSI options are connected correctly. 2. The last option in each SCSI chain, or the end of the SCSI cable, is terminated correctly. 3. All external SCSI options are turned on. You must turn on external SCSI options before turning on the server. <p>If the problem remains, call for service.</p>
Power	Verify that:
The server does not power on.	<ol style="list-style-type: none"> 1. The LEDs on the power supply are lit. 2. The power cables are properly connected to the server. 3. The ac power source functions properly. 4. If you just installed an option, remove it, and restart the server. If the server now turns on, you might have installed more options than the power supplies support. <p>If the problem remains, call for service.</p>
Serial port	Verify that the serial-port adapter, if you installed one, is seated properly. If the problem remains, call for service.
The number of serial ports identified by the operating system is less than the number of serial ports installed.	
A serial device does not work.	<p>Verify that:</p> <ol style="list-style-type: none"> 1. The device is compatible with the server. 2. The serial port is enabled and is assigned a unique address. <p>Note: Serial devices are configured by default as system console devices.</p> <p>If the problem remains, call for service.</p>

Table 5. Troubleshooting charts (continued)

Device	Suggested action
<p>Software</p>	<p>To determine whether problems are caused by the software, verify that:</p> <ol style="list-style-type: none"> 1. Your server has the minimum memory needed to use the software. For memory requirements, see the information that comes with the software. Note: If you have just installed an adapter or memory, you might have a memory address conflict. 2. The software is designed to operate on your server (startable DOS media will not operate on your server). 3. Other software works on your server.
<p>Suspected software problem.</p>	<p>If you received any error messages when using the software program, see the information that comes with the software for a description of the messages and solutions to the problem.</p> <p>If the items above are correct and the problem remains, contact your place of purchase.</p>
<p>Universal Serial Bus (USB) ports</p>	<p>Verify that the correct USB device driver is installed.</p>
<p>A USB device does not work.</p>	<p>If the problem remains, call for service.</p>

Chapter 6. Getting help and technical assistance

If you need help, service, or technical assistance or just want more information about IBM products, you will find a wide variety of sources available from IBM to assist you. This appendix contains information about where to go for additional information about IBM and IBM products, what to do if you experience a problem with your xSeries or IntelliStation[®] system, and whom to call for service, if it is necessary.

Before you call

Before you call, make sure that you have taken these steps to try to solve the problem yourself:

- Check all cables to make sure that they are connected.
- Check the power switches to make sure that the system is turned on.
- Use the troubleshooting information in your system documentation, and use the diagnostic tools that come with your system.
- Go to the IBM Support Web site at <http://www.ibm.com/pc/support/> to check for technical information, hints, tips, and new device drivers.
- Use an IBM discussion forum on the IBM Web site to ask questions.

You can solve many problems without outside assistance by following the troubleshooting procedures that IBM provides in the online help or in the publications that are provided with your system and software. The information that comes with your system also describes the diagnostic tests that you can perform. Most xSeries and IntelliStation systems, operating systems, and programs come with information that contains troubleshooting procedures and explanations of error messages and error codes. If you suspect a software problem, see the information for the operating system or program.

Using the documentation

Information about your IBM xSeries or IntelliStation system and preinstalled software, if any, is available in the documentation that comes with your system. That documentation includes printed books, online books, README files, and help files. See the troubleshooting information in your system documentation for instructions for using the diagnostic programs. The troubleshooting information or the diagnostic programs might tell you that you need additional or updated device drivers or other software. IBM maintains pages on the World Wide Web where you can get the latest technical information and download device drivers and updates. To access these pages, go to <http://www.ibm.com/pc/support/> and follow the instructions. Also, you can order publications through the IBM Publications Ordering System at <http://www.elink.ibm.com/public/applications/publications/cgibin/pbi.cgi>.

Getting help and information from the World Wide Web

On the World Wide Web, the IBM Web site has up-to-date information about IBM xSeries and IntelliStation products, services, and support. The address for IBM xSeries information is <http://www.ibm.com/eserver/xseries/>. The address for IBM IntelliStation information is <http://www.ibm.com/pc/intellistation/>.

You can find service information for your IBM products, including supported options, at <http://www.ibm.com/pc/support/>. If you click **Profile** from the support page, you can create a customized support page. The support page has many sources of information and ways for you to solve problems, including:

- Diagnosing problems, using the IBM Online Assistant
- Downloading the latest device drivers and updates for your products
- Viewing Frequently Asked Questions (FAQ)
- Viewing hints and tips to help you solve problems
- Participating in IBM discussion forums
- Setting up e-mail notification of technical updates about your products

Software service and support

Through IBM Support Line, you can get telephone assistance, for a fee, with usage, configuration, and software problems with xSeries servers, IntelliStation workstations, and appliances. For information about which products are supported by Support Line in your country or region, go to <http://www.ibm.com/services/sl/products/>.

For more information about Support Line and other IBM services, go to <http://www.ibm.com/services/>, or go to <http://www.ibm.com/planetwide/> for support telephone numbers.

Hardware service and support

You can receive hardware service through IBM Integrated Technology Services or through your IBM reseller, if your reseller is authorized by IBM to provide warranty service. Go to <http://www.ibm.com/planetwide/> for support telephone numbers.

In the U.S. and Canada, hardware service and support is available 24 hours a day, 7 days a week. In the U.K., these services are available Monday through Friday, from 9 a.m. to 6 p.m.

Appendix A. Warranty information

This section contains information about your warranty period and the service and support that are provided by your warranty.

Warranty period

The warranty period varies by machine type and country or region.

Contact your place of purchase for warranty service information. Some IBM Machines are eligible for on-site warranty service depending on the country or region where service is performed.

Prior to on-site warranty service, you are required to go through problem determination with an IBM service specialist call center technician.

This paragraph applies only to products with a warranty period of 3 years on parts and 1 year on labor. A warranty period of 3 years on parts and 1 year on labor means that IBM will provide warranty service without charge for:

1. parts and labor during the first year of the warranty period
2. parts only, on an exchange basis, in the second and third years of the warranty period. IBM will charge you for any labor it provides in performance of the repair or replacement.

The IBM Machine Warranties Web site at http://www.ibm.com/servers/support/machine_warranties/ contains a worldwide overview of the IBM Statement of Limited Warranty for IBM Machines, a glossary of terms used in the Statement of Limited Warranty, Frequently Asked Questions (FAQ), and links to Product Support Web pages. The IBM Statement of Limited Warranty is available from this Web site in 29 languages in Portable Document Format (PDF).

Machine - IBM @server xSeries 450

Country or region	Warranty period	Service delivery method
All	1 year	On-site

Problem determination

Prior to on-site warranty service, you are required to go through problem determination with an IBM service specialist call center technician. The service specialist will run diagnostic tests on the hardware and check the software.

Running diagnostics

The IBM service specialist will help you determine whether your equipment is functioning as specified. It might be necessary to isolate the failing xSeries, Netfinity®, or IntelliStation system; IBM component; or both from any active production environment to run diagnostics and perform defect-isolation programs. You are responsible for making the system, IBM component, or both available for running diagnostics and defect-isolation programs.

Checking software

The IBM service specialist will help you ensure that the correct BIOS code, firmware, device drivers, and other supporting IBM software are installed and correctly configured. It might be necessary to manually gather information about the

relevant software levels or run IBM-approved utility programs to gather this information. It might be necessary to isolate the failing system from any active production environment to gather this information. You are responsible, with assistance from the service specialist, for gathering this information. The IBM Statement of Limited Warranty does not include on-site assistance with this activity.

Warranty service and support

With the original purchase of an IBM xSeries or IntelliStation system, you have access to extensive service and support. During the IBM Machine warranty period, you may call IBM or your reseller for problem-determination assistance under the terms of the IBM Statement of Limited Warranty.

The following services are available during the warranty period:

- **Problem determination** - Trained personnel are available to assist you with determining if you have a hardware problem and deciding what action is necessary to fix the problem.
- **IBM hardware repair** - If the problem is determined to be caused by IBM hardware under warranty, trained service personnel are available to provide the applicable level of service, either on-site or at an IBM service center as determined by IBM.
- **Engineering Change management** - Occasionally, there might be changes that are required after a product has been shipped from IBM. In those instances, IBM will make Engineering Changes (ECs) available that apply to your hardware.
- **Customer replaceable units (CRUs)** - Some parts of IBM xSeries and IntelliStation systems are designated as customer replaceable units. IBM ships CRUs to you for replacement by you. CRUs include keyboards, monitors, memory, diskette drives, hard disk drives, and mice (this list is not inclusive of all CRUs).

The following items are not covered under warranty service:

- Replacement or use of non-IBM parts. All IBM parts contain a 7-character identification in the format IBM FRU XXXXXXXX.
- Identification of software problem sources.
- Installation of customer replaceable units (CRUs).
- Installation and configuration of BIOS code, firmware, or device drivers that are designated as customer installable.

See the IBM Statement of Limited Warranty for a full explanation of IBM warranty terms. Be sure to retain your proof of purchase to obtain warranty service.

Please have the following information ready when you call:

- The machine type and model of your IBM hardware product (if available)
- Serial numbers of your IBM hardware products
- A description of the problem
- The exact wording of any error messages
- Hardware and software configuration information

International Warranty Service

If you travel with your xSeries or IntelliStation system or relocate it to a country or region where your system is sold and serviced by IBM or IBM resellers authorized

to perform warranty service, International Warranty Service (IWS) is available during the warranty period. Eligible IBM systems are identified by their four-digit machine types.

You can obtain IWS through the service delivery method (such as depot, carry-in, or on-site) provided in the servicing country or region. Service methods and procedures vary by country or region, and some service or parts might not be available in all countries and regions. Service centers in certain countries or regions might not be able to service all models of a particular machine type. In addition, some countries or regions might have fees and restrictions that apply at the time of service.

To determine whether your system is eligible for IWS, go to <http://www.ibm.com/pc/support/> and click **Warranty lookup**.

Purchasing additional services

During and after the warranty period, you can purchase additional services, such as support for IBM and non-IBM hardware, operating systems, and application programs; network setup and configuration; upgraded or extended hardware repair services; and custom installations. Service availability and service name might vary by country or region.

For more information about these services, contact your IBM marketing representative.

IBM Statement of Limited Warranty Z125-4753-06 8/2000

Part 1 - General Terms

This Statement of Limited Warranty includes Part 1 - General Terms and Part 2 - Country-unique Terms. The terms of Part 2 replace or modify those of Part 1. The warranties provided by IBM in this Statement of Limited Warranty apply only to Machines you purchase for your use, and not for resale, from IBM or your reseller. The term "Machine" means an IBM machine, its features, conversions, upgrades, elements, or accessories, or any combination of them. The term "Machine" does not include any software programs, whether pre-loaded with the Machine, installed subsequently or otherwise. Unless IBM specifies otherwise, the following warranties apply only in the country where you acquire the Machine. Nothing in this Statement of Limited Warranty affects any statutory rights of consumers that cannot be waived or limited by contract. If you have any questions, contact IBM or your reseller.

The IBM Warranty for Machines: IBM warrants that each Machine 1) is free from defects in materials and workmanship and 2) conforms to IBM's Official Published Specifications ("Specifications"). The warranty period for a Machine is a specified, fixed period commencing on its Date of Installation. The date on your sales receipt is the Date of Installation unless IBM or your reseller informs you otherwise.

If a Machine does not function as warranted during the warranty period, and IBM or your reseller are unable to either 1) make it do so or 2) replace it with one that is at least functionally equivalent, you may return it to your place of purchase and your money will be refunded.

Extent of Warranty: The warranty does not cover the repair or exchange of a Machine resulting from misuse, accident, modification, unsuitable physical or operating environment, improper maintenance by you, or failure caused by a product for which IBM is not responsible. The warranty is voided by removal or alteration of Machine or parts identification labels.

THESE WARRANTIES ARE YOUR EXCLUSIVE WARRANTIES AND REPLACE ALL OTHER WARRANTIES OR CONDITIONS, EXPRESS OR IMPLIED, INCLUDING, BUT NOT LIMITED TO, THE IMPLIED WARRANTIES OR CONDITIONS OF MERCHANTABILITY AND FITNESS FOR A PARTICULAR PURPOSE. THESE WARRANTIES GIVE YOU SPECIFIC LEGAL RIGHTS AND YOU MAY ALSO HAVE OTHER RIGHTS WHICH VARY FROM JURISDICTION TO JURISDICTION. SOME JURISDICTIONS DO NOT ALLOW THE EXCLUSION OR LIMITATION OF EXPRESS OR IMPLIED WARRANTIES, SO THE ABOVE EXCLUSION OR LIMITATION MAY NOT APPLY TO YOU. IN THAT EVENT, SUCH WARRANTIES ARE LIMITED IN DURATION TO THE WARRANTY PERIOD. NO WARRANTIES APPLY AFTER THAT PERIOD.

Items Not Covered by Warranty: IBM does not warrant uninterrupted or error-free operation of a Machine. Any technical or other support provided for a Machine under warranty, such as assistance via telephone with "how-to" questions and those regarding Machine set-up and installation, will be provided **WITHOUT WARRANTIES OF ANY KIND.**

Warranty Service: To obtain warranty service for a Machine, contact IBM or your reseller. If you do not register your Machine with IBM, you may be required to present proof of purchase.

During the warranty period, IBM or your reseller, if approved by IBM to provide warranty service, provides without charge certain types of repair and exchange service to keep Machines in, or restore them to, conformance with their Specifications. IBM or your reseller will inform you of the available types of service for a Machine based on its country of installation. At its discretion, IBM or your reseller will 1) either repair or exchange the failing Machine and 2) provide the service either at your location or a service center. IBM or your reseller will also manage and install selected engineering changes that apply to the Machine.

Some parts of IBM Machines are designated as Customer Replaceable Units (called "CRUs"), e.g., keyboards, memory, or hard disk drives. IBM ships CRUs to you for replacement by you. You must return all defective CRUs to IBM within 30 days of your receipt of the replacement CRU. You are responsible for downloading designated Machine Code and Licensed Internal Code updates from an IBM Internet Web site or from other electronic media, and following the instructions that IBM provides.

When warranty service involves the exchange of a Machine or part, the item IBM or your reseller replaces becomes its property and the replacement becomes yours. You represent that all removed items are genuine and unaltered. The replacement may not be new, but will be in good working order and at least functionally equivalent to the item replaced. The replacement assumes the warranty service status of the replaced item. Many features, conversions, or upgrades involve the removal of parts and their return to IBM. A part that replaces a removed part will assume the warranty service status of the removed part.

Before IBM or your reseller exchanges a Machine or part, you agree to remove all features, parts, options, alterations, and attachments not under warranty service.

You also agree to

1. ensure that the Machine is free of any legal obligations or restrictions that prevent its exchange;
2. obtain authorization from the owner to have IBM or your reseller service a Machine that you do not own; and
3. where applicable, before service is provided:
 - a. follow the problem determination, problem analysis, and service request procedures that IBM or your reseller provides;
 - b. secure all programs, data, and funds contained in a Machine;
 - c. provide IBM or your reseller with sufficient, free, and safe access to your facilities to permit them to fulfill their obligations; and
 - d. inform IBM or your reseller of changes in a Machine's location.

IBM is responsible for loss of, or damage to, your Machine while it is 1) in IBM's possession or 2) in transit in those cases where IBM is responsible for the transportation charges.

Neither IBM nor your reseller is responsible for any of your confidential, proprietary or personal information contained in a Machine which you return to IBM or your reseller for any reason. You should remove all such information from the Machine prior to its return.

Limitation of Liability: Circumstances may arise where, because of a default on IBM's part or other liability, you are entitled to recover damages from IBM. In each such instance, regardless of the basis on which you are entitled to claim damages from IBM (including fundamental breach, negligence, misrepresentation, or other

contract or tort claim), except for any liability that cannot be waived or limited by applicable laws, IBM is liable for no more than

1. damages for bodily injury (including death) and damage to real property and tangible personal property; and
2. the amount of any other actual direct damages, up to the charges (if recurring, 12 months' charges apply) for the Machine that is subject of the claim. For purposes of this item, the term "Machine" includes Machine Code and Licensed Internal Code.

This limit also applies to IBM's suppliers and your reseller. It is the maximum for which IBM, its suppliers, and your reseller are collectively responsible.

UNDER NO CIRCUMSTANCES IS IBM LIABLE FOR ANY OF THE FOLLOWING: 1) THIRD-PARTY CLAIMS AGAINST YOU FOR DAMAGES (OTHER THAN THOSE UNDER THE FIRST ITEM LISTED ABOVE); 2) LOSS OF, OR DAMAGE TO, YOUR RECORDS OR DATA; OR 3) SPECIAL, INCIDENTAL, OR INDIRECT DAMAGES OR FOR ANY ECONOMIC CONSEQUENTIAL DAMAGES, LOST PROFITS OR LOST SAVINGS, EVEN IF IBM, ITS SUPPLIERS OR YOUR RESELLER IS INFORMED OF THEIR POSSIBILITY. SOME JURISDICTIONS DO NOT ALLOW THE EXCLUSION OR LIMITATION OF INCIDENTAL OR CONSEQUENTIAL DAMAGES, SO THE ABOVE LIMITATION OR EXCLUSION MAY NOT APPLY TO YOU.

Governing Law: Both you and IBM consent to the application of the laws of the country in which you acquired the Machine to govern, interpret, and enforce all of your and IBM's rights, duties, and obligations arising from, or relating in any manner to, the subject matter of this Agreement, without regard to conflict of law principles.

Part 2 - Country-unique Terms

AMERICAS

BRAZIL

Governing Law: *The following is added after the first sentence:*

Any litigation arising from this Agreement will be settled exclusively by the court of Rio de Janeiro.

NORTH AMERICA

Warranty Service: *The following is added to this Section:*

To obtain warranty service from IBM in Canada or the United States, call 1-800-IBM-SERV (426-7378).

CANADA

Governing Law: *The following replaces "laws of the country in which you acquired the Machine" in the first sentence:*

laws in the Province of Ontario.

UNITED STATES

Governing Law: *The following replaces "laws of the country in which you acquired the Machine" in the first sentence:*

laws of the State of New York.

ASIA PACIFIC

AUSTRALIA

The IBM Warranty for Machines: *The following paragraph is added to this Section:*
The warranties specified in this Section are in addition to any rights you may have under the Trade Practices Act 1974 or other similar legislation and are only limited to the extent permitted by the applicable legislation.

Limitation of Liability: *The following is added to this Section:*

Where IBM is in breach of a condition or warranty implied by the Trade Practices Act 1974 or other similar legislation, IBM's liability is limited to the repair or replacement of the goods or the supply of equivalent goods. Where that condition or warranty relates to right to sell, quiet possession or clear title, or the goods are of a kind ordinarily acquired for personal, domestic or household use or consumption, then none of the limitations in this paragraph apply.

Governing Law: *The following replaces "laws of the country in which you acquired the Machine" in the first sentence:*
laws of the State or Territory.

CAMBODIA, LAOS, AND VIETNAM

Governing Law: *The following replaces "laws of the country in which you acquired the Machine" in the first sentence:*
laws of the State of New York.

The following is added to this Section:

Disputes and differences arising out of or in connection with this Agreement shall be finally settled by arbitration which shall be held in Singapore in accordance with the rules of the International Chamber of Commerce (ICC). The arbitrator or arbitrators designated in conformity with those rules shall have the power to rule on their own competence and on the validity of the Agreement to submit to arbitration. The arbitration award shall be final and binding for the parties without appeal and the arbitral award shall be in writing and set forth the findings of fact and the conclusions of law.

All proceedings shall be conducted, including all documents presented in such proceedings, in the English language. The number of arbitrators shall be three, with each side to the dispute being entitled to appoint one arbitrator.

The two arbitrators appointed by the parties shall appoint a third arbitrator before proceeding upon the reference. The third arbitrator shall act as chairman of the proceedings. Vacancies in the post of chairman shall be filled by the president of the ICC. Other vacancies shall be filled by the respective nominating party. Proceedings shall continue from the stage they were at when the vacancy occurred.

If one of the parties refuses or otherwise fails to appoint an arbitrator within 30 days of the date the other party appoints its, the first appointed arbitrator shall be the sole arbitrator, provided that the arbitrator was validly and properly appointed.

The English language version of this Agreement prevails over any other language version.

HONG KONG AND MACAU

Governing Law: *The following replaces “laws of the country in which you acquired the Machine” in the first sentence:*
laws of Hong Kong Special Administrative Region.

INDIA

Limitation of Liability: *The following replaces items 1 and 2 of this Section:*

1. liability for bodily injury (including death) or damage to real property and tangible personal property will be limited to that caused by IBM’s negligence;
2. as to any other actual damage arising in any situation involving nonperformance by IBM pursuant to, or in any way related to the subject of this Statement of Limited Warranty, IBM’s liability will be limited to the charge paid by you for the individual Machine that is the subject of the claim.

JAPAN

Governing Law: *The following sentence is added to this Section:*

Any doubts concerning this Agreement will be initially resolved between us in good faith and in accordance with the principle of mutual trust.

NEW ZEALAND

The IBM Warranty for Machines: *The following paragraph is added to this Section:*

The warranties specified in this Section are in addition to any rights you may have under the Consumer Guarantees Act 1993 or other legislation which cannot be excluded or limited. The Consumer Guarantees Act 1993 will not apply in respect of any goods which IBM provides, if you require the goods for the purposes of a business as defined in that Act.

Limitation of Liability: *The following is added to this Section:*

Where Machines are not acquired for the purposes of a business as defined in the Consumer Guarantees Act 1993, the limitations in this Section are subject to the limitations in that Act.

PEOPLE’S REPUBLIC OF CHINA (PRC)

Governing Law: *The following replaces this Section:*

Both you and IBM consent to the application of the laws of the State of New York (except when local law requires otherwise) to govern, interpret, and enforce all your and IBM’s rights, duties, and obligations arising from, or relating in any manner to, the subject matter of this Agreement, without regard to conflict of law principles.

Any disputes arising from or in connection with this Agreement will first be resolved by friendly negotiations, failing which either of us has the right to submit the dispute to the China International Economic and Trade Arbitration Commission in Beijing, the PRC, for arbitration in accordance with its arbitration rules in force at the time. The arbitration tribunal will consist of three arbitrators. The language to be used therein will be English and Chinese. An arbitral award will be final and binding on all the parties, and will be enforceable under the Convention on the Recognition and Enforcement of Foreign Arbitral Awards (1958).

The arbitration fee will be borne by the losing party unless otherwise determined by the arbitral award.

During the course of arbitration, this Agreement will continue to be performed except for the part which the parties are disputing and which is undergoing arbitration.

EUROPE, MIDDLE EAST, AFRICA (EMEA)

THE FOLLOWING TERMS APPLY TO ALL EMEA COUNTRIES:

The terms of this Statement of Limited Warranty apply to Machines purchased from IBM or an IBM reseller.

Warranty Service: If you purchase an IBM Machine in Austria, Belgium, Denmark, Estonia, Finland, France, Germany, Greece, Iceland, Ireland, Italy, Latvia, Lithuania, Luxembourg, Netherlands, Norway, Portugal, Spain, Sweden, Switzerland or United Kingdom, you may obtain warranty service for that Machine in any of those countries from either (1) an IBM reseller approved to perform warranty service or (2) from IBM. If you purchase an IBM Personal Computer Machine in Albania, Armenia, Belarus, Bosnia and Herzegovina, Bulgaria, Croatia, Czech Republic, Georgia, Hungary, Kazakhstan, Kirghizia, Federal Republic of Yugoslavia, Former Yugoslav Republic of Macedonia (FYROM), Moldova, Poland, Romania, Russia, Slovak Republic, Slovenia, or Ukraine, you may obtain warranty service for that Machine in any of those countries from either (1) an IBM reseller approved to perform warranty service or (2) from IBM.

If you purchase an IBM Machine in a Middle Eastern or African country, you may obtain warranty service for that Machine from the IBM entity within the country of purchase, if that IBM entity provides warranty service in that country, or from an IBM reseller, approved by IBM to perform warranty service on that Machine in that country. Warranty service in Africa is available within 50 kilometers of an IBM authorized service provider. You are responsible for transportation costs for Machines located outside 50 kilometers of an IBM authorized service provider.

Governing Law: The applicable laws that govern, interpret and enforce rights, duties, and obligations of each of us arising from, or relating in any manner to, the subject matter of this Statement, without regard to conflict of laws principles, as well as Country-unique terms and competent court for this Statement are those of the country in which the warranty service is being provided, except that in 1) Albania, Bosnia-Herzegovina, Bulgaria, Croatia, Hungary, Former Yugoslav Republic of Macedonia, Romania, Slovakia, Slovenia, Armenia, Azerbaijan, Belarus, Georgia, Kazakhstan, Kyrgyzstan, Moldova, Russia, Tajikistan, Turkmenistan, Ukraine, and Uzbekistan, the laws of Austria apply; 2) Estonia, Latvia, and Lithuania, the laws of Finland apply; 3) Algeria, Benin, Burkina Faso, Cameroon, Cape Verde, Central African Republic, Chad, Congo, Djibouti, Democratic Republic of Congo, Equatorial Guinea, France, Gabon, Gambia, Guinea, Guinea-Bissau, Ivory Coast, Lebanon, Mali, Mauritania, Morocco, Niger, Senegal, Togo, and Tunisia, this Agreement will be construed and the legal relations between the parties will be determined in accordance with the French laws and all disputes arising out of this Agreement or related to its violation or execution, including summary proceedings, will be settled exclusively by the Commercial Court of Paris; 4) Angola, Bahrain, Botswana, Burundi, Egypt, Eritrea, Ethiopia, Ghana, Jordan, Kenya, Kuwait, Liberia, Malawi, Malta, Mozambique, Nigeria, Oman, Pakistan, Qatar, Rwanda, Sao Tome, Saudi Arabia, Sierra Leone, Somalia, Tanzania, Uganda, United Arab Emirates, United Kingdom, West Bank/Gaza, Yemen, Zambia, and Zimbabwe, this Agreement will be governed by English Law and disputes relating to it will be submitted to the exclusive jurisdiction of the English courts; and 5) in Greece, Israel, Italy, Portugal,

and Spain any legal claim arising out of this Statement will be brought before, and finally settled by, the competent court of Athens, Tel Aviv, Milan, Lisbon, and Madrid, respectively.

THE FOLLOWING TERMS APPLY TO THE COUNTRY SPECIFIED:

AUSTRIA AND GERMANY

The IBM Warranty for Machines: *The following replaces the first sentence of the first paragraph of this Section:*

The warranty for an IBM Machine covers the functionality of the Machine for its normal use and the Machine's conformity to its Specifications.

The following paragraphs are added to this Section:

The minimum warranty period for Machines is six months. In case IBM or your reseller is unable to repair an IBM Machine, you can alternatively ask for a partial refund as far as justified by the reduced value of the unrepaired Machine or ask for a cancellation of the respective agreement for such Machine and get your money refunded.

Extent of Warranty: *The second paragraph does not apply.*

Warranty Service: *The following is added to this Section:*

During the warranty period, transportation for delivery of the failing Machine to IBM will be at IBM's expense.

Limitation of Liability: *The following paragraph is added to this Section:*

The limitations and exclusions specified in the Statement of Limited Warranty will not apply to damages caused by IBM with fraud or gross negligence and for express warranty.

The following sentence is added to the end of item 2:

IBM's liability under this item is limited to the violation of essential contractual terms in cases of ordinary negligence.

EGYPT

Limitation of Liability: *The following replaces item 2 in this Section:*

as to any other actual direct damages, IBM's liability will be limited to the total amount you paid for the Machine that is the subject of the claim. For purposes of this item, the term "Machine" includes Machine Code and Licensed Internal Code.

Applicability of suppliers and resellers (unchanged).

FRANCE

Limitation of Liability: *The following replaces the second sentence of the first paragraph of this Section:*

In such instances, regardless of the basis on which you are entitled to claim damages from IBM, IBM is liable for no more than: *(items 1 and 2 unchanged).*

IRELAND

Extent of Warranty: *The following is added to this Section:*

Except as expressly provided in these terms and conditions, all statutory conditions,

including all warranties implied, but without prejudice to the generality of the foregoing all warranties implied by the Sale of Goods Act 1893 or the Sale of Goods and Supply of Services Act 1980 are hereby excluded.

Limitation of Liability: *The following replaces items one and two of the first paragraph of this Section:*

1. death or personal injury or physical damage to your real property solely caused by IBM's negligence; and
2. the amount of any other actual direct damages, up to 125 percent of the charges (if recurring, the 12 months' charges apply) for the Machine that is the subject of the claim or which otherwise gives rise to the claim.

Applicability of suppliers and resellers (unchanged).

The following paragraph is added at the end of this Section:

IBM's entire liability and your sole remedy, whether in contract or in tort, in respect of any default shall be limited to damages.

ITALY

Limitation of Liability: *The following replaces the second sentence in the first paragraph:*

In each such instance unless otherwise provided by mandatory law, IBM is liable for no more than:

1. *(unchanged)*
2. as to any other actual damage arising in all situations involving nonperformance by IBM pursuant to, or in any way related to the subject matter of this Statement of Warranty, IBM's liability, will be limited to the total amount you paid for the Machine that is the subject of the claim.

Applicability of suppliers and resellers (unchanged).

The following replaces the third paragraph of this Section:

Unless otherwise provided by mandatory law, IBM and your reseller are not liable for any of the following: *(items 1 and 2 unchanged)* 3) indirect damages, even if IBM or your reseller is informed of their possibility.

SOUTH AFRICA, NAMIBIA, BOTSWANA, LESOTHO AND SWAZILAND

Limitation of Liability: *The following is added to this Section:*

IBM's entire liability to you for actual damages arising in all situations involving nonperformance by IBM in respect of the subject matter of this Statement of Warranty will be limited to the charge paid by you for the individual Machine that is the subject of your claim from IBM.

UNITED KINGDOM

Limitation of Liability: *The following replaces items 1 and 2 of the first paragraph of this Section:*

1. death or personal injury or physical damage to your real property solely caused by IBM's negligence;
2. the amount of any other actual direct damages or loss, up to 125 percent of the charges (if recurring, the 12 months' charges apply) for the Machine that is the subject of the claim or which otherwise gives rise to the claim;

The following item is added to this paragraph:

3. breach of IBM's obligations implied by Section 12 of the Sale of Goods Act 1979 or Section 2 of the Supply of Goods and Services Act 1982.

Applicability of suppliers and resellers (unchanged).

The following is added to the end of this Section:

IBM's entire liability and your sole remedy, whether in contract or in tort, in respect of any default shall be limited to damages.

Appendix B. Notices

This information was developed for products and services offered in the U.S.A.

IBM may not offer the products, services, or features discussed in this document in other countries. Consult your local IBM representative for information on the products and services currently available in your area. Any reference to an IBM product, program, or service is not intended to state or imply that only that IBM product, program, or service may be used. Any functionally equivalent product, program, or service that does not infringe any IBM intellectual property right may be used instead. However, it is the user's responsibility to evaluate and verify the operation of any non-IBM product, program, or service.

IBM may have patents or pending patent applications covering subject matter described in this document. The furnishing of this document does not give you any license to these patents. You can send license inquiries, in writing, to:

*IBM Director of Licensing
IBM Corporation
North Castle Drive
Armonk, NY 10504-1785
U.S.A.*

INTERNATIONAL BUSINESS MACHINES CORPORATION PROVIDES THIS PUBLICATION "AS IS" WITHOUT WARRANTY OF ANY KIND, EITHER EXPRESS OR IMPLIED, INCLUDING, BUT NOT LIMITED TO, THE IMPLIED WARRANTIES OF NON-INFRINGEMENT, MERCHANTABILITY OR FITNESS FOR A PARTICULAR PURPOSE. Some states do not allow disclaimer of express or implied warranties in certain transactions, therefore, this statement may not apply to you.

This information could include technical inaccuracies or typographical errors. Changes are periodically made to the information herein; these changes will be incorporated in new editions of the publication. IBM may make improvements and/or changes in the product(s) and/or the program(s) described in this publication at any time without notice.

Any references in this information to non-IBM Web sites are provided for convenience only and do not in any manner serve as an endorsement of those Web sites. The materials at those Web sites are not part of the materials for this IBM product, and use of those Web sites is at your own risk.

IBM may use or distribute any of the information you supply in any way it believes appropriate without incurring any obligation to you.

Edition notice

**© COPYRIGHT INTERNATIONAL BUSINESS MACHINES CORPORATION, 2003.
All rights reserved.**

Note to U.S. Government Users Restricted Rights — Use, duplication or disclosure restricted by GSA ADP Schedule Contract with IBM Corp.

Trademarks

The following terms are trademarks of International Business Machines Corporation in the United States, other countries, or both:

Active Memory	OS/2 WARP
Active PCI	Predictive Failure Analysis
Active PCI-X	PS/2
Alert on LAN	ServeRAID
C2T Interconnect	ServerGuide
Chipkill	ServerProven
EtherJet	TechConnect
e-business logo	Tivoli
@server	Tivoli Enterprise
FlashCopy	Update Connector
IBM	Wake on LAN
IntelliStation	XA-32
Light Path Diagnostics	XA-64
Memory ProteXion	X-Architecture
NetBAY	XceL4
Netfinity	XpandOnDemand
NetView	xSeries

Lotus, Lotus Notes, SmartSuite, and Domino are trademarks of Lotus Development Corporation and/or IBM Corporation in the United States, other countries, or both.

Intel, ActionMedia, Itanium, LANDesk, MMX, Pentium, and ProShare are trademarks of Intel Corporation in the United States, other countries, or both.

Microsoft, Windows, and Windows NT are trademarks of Microsoft Corporation in the United States, other countries, or both.

UNIX is a registered trademark of The Open Group in the United States and other countries.

Java and all Java-based trademarks and logos are trademarks or registered trademarks of Sun Microsystems, Inc. in the United States, other countries, or both.

Linux is a registered trademark of Linus Torvalds.

Other company, product, or service names may be trademarks or service marks of others.

Important notes

Processor speeds indicate the internal clock speed of the microprocessor; other factors also affect application performance.

CD-ROM drive speeds list the variable read rate. Actual speeds vary and are often less than the maximum possible.

When referring to processor storage, real and virtual storage, or channel volume, KB stands for approximately 1000 bytes, MB stands for approximately 1 000 000 bytes, and GB stands for approximately 1 000 000 000 bytes.

When referring to hard disk drive capacity or communications volume, MB stands for 1 000 000 bytes, and GB stands for 1 000 000 000 bytes. Total user-accessible capacity may vary depending on operating environments.

Maximum internal hard disk drive capacities assume the replacement of any standard hard disk drives and population of all hard disk drive bays with the largest currently supported drives available from IBM.

Maximum memory may require replacement of the standard memory with an optional memory module.

IBM makes no representation or warranties regarding non-IBM products and services that are ServerProven, including but not limited to the implied warranties of merchantability and fitness for a particular purpose. These products are offered and warranted solely by third parties.

IBM makes no representations or warranties with respect to non-IBM products. Support (if any) for the non-IBM products is provided by the third party, not IBM.

Some software may differ from its retail version (if available), and may not include user manuals or all program functionality.

Product recycling and disposal

This unit contains materials such as circuit boards, cables, electromagnetic compatibility gaskets, and connectors which may contain lead and copper/beryllium alloys that require special handling and disposal at end of life. Before this unit is disposed of, these materials must be removed and recycled or discarded according to applicable regulations. IBM offers product-return programs in several countries. For country-specific instructions, refer to the following Web site:
<http://www.ibm.com/ibm/environment/products/prp.shtml>.

This product may contain a sealed lead acid, nickel cadmium, nickel metal hydride, lithium, or lithium ion battery. Consult your user manual or service manual for specific battery information. The battery must be recycled or disposed of properly. Recycling facilities may not be available in your area. For information on disposal of batteries, contact your local waste disposal facility.

In the United States, IBM has established a collection process for reuse, recycling, or proper disposal of used IBM sealed lead acid, nickel cadmium, nickel metal hydride, and battery packs from IBM equipment. For information on proper disposal of these batteries, contact IBM at 1-800-426-4333. Have the IBM part number listed on the battery available prior to your call.

Electronic emission notices

Federal Communications Commission (FCC) statement

Note: This equipment has been tested and found to comply with the limits for a Class A digital device, pursuant to Part 15 of the FCC Rules. These limits are designed to provide reasonable protection against harmful interference when the

equipment is operated in a commercial environment. This equipment generates, uses, and can radiate radio frequency energy and, if not installed and used in accordance with the instruction manual, may cause harmful interference to radio communications. Operation of this equipment in a residential area is likely to cause harmful interference, in which case the user will be required to correct the interference at his own expense.

Properly shielded and grounded cables and connectors must be used in order to meet FCC emission limits. Properly shielded and grounded cables and connectors must be used in order to meet FCC emission limits. IBM is not responsible for any radio or television interference caused by using other than recommended cables and connectors or by using other than recommended cables and connectors or by unauthorized changes or modifications to this equipment. Unauthorized changes or modifications could void the user's authority to operate the equipment.

This device complies with Part 15 of the FCC Rules. Operation is subject to the following two conditions: (1) this device may not cause harmful interference, and (2) this device must accept any interference received, including interference that may cause undesired operation.

Industry Canada Class A emission compliance statement

This Class A digital apparatus complies with Canadian ICES-003.

Avis de conformité à la réglementation d'Industrie Canada

Cet appareil numérique de la classe A est conforme à la norme NMB-003 du Canada.

Australia and New Zealand Class A statement

Attention: This is a Class A product. In a domestic environment this product may cause radio interference in which case the user may be required to take adequate measures.

United Kingdom telecommunications safety requirement

Notice to Customers

This apparatus is approved under approval number NS/G/1234/J/100003 for indirect connection to public telecommunication systems in the United Kingdom.

European Union EMC Directive conformance statement

This product is in conformity with the protection requirements of EU Council Directive 89/336/EEC on the approximation of the laws of the Member States relating to electromagnetic compatibility. IBM cannot accept responsibility for any failure to satisfy the protection requirements resulting from a nonrecommended modification of the product, including the fitting of non-IBM option cards.

This product has been tested and found to comply with the limits for Class A Information Technology Equipment according to CISPR 22/European Standard EN 55022. The limits for Class A equipment were derived for commercial and industrial environments to provide reasonable protection against interference with licensed communication equipment.

Attention: This is a Class A product. In a domestic environment this product may cause radio interference in which case the user may be required to take adequate measures.

Taiwanese Class A warning statement

警告使用者：
這是甲類的資訊產品，在居住的環境中使用時，可能會造成射頻干擾，在這種情況下，使用者會被要求採取某些適當的對策。

Chinese Class A warning statement

聲 明
此為 A 級產品。在生活環境中，該產品可能會造成無線電干擾。在這種情況下，可能需要用戶對其干擾採取切实可行的措施。

Japanese Voluntary Control Council for Interference (VCCI) statement

この装置は、情報処理装置等電波障害自主規制協議会（VCCI）の基準に基づきクラスA情報技術装置です。この装置を家庭環境で使用すると電波妨害を引き起こすことがあります。この場合には使用者が適切な対策を講ずるよう要求されることがあります。

Power cords

For your safety, IBM provides a power cord with a grounded attachment plug to use with this IBM product. To avoid electrical shock, always use the power cord and plug with a properly grounded outlet.

IBM power cords used in the United States and Canada are listed by Underwriter's Laboratories (UL) and certified by the Canadian Standards Association (CSA).

For units intended to be operated at 115 volts: Use a UL-listed and CSA-certified cord set consisting of a minimum 18 AWG, Type SVT or SJT, three-conductor cord, a maximum of 15 feet in length and a parallel blade, grounding-type attachment plug rated 15 amperes, 125 volts.

For units intended to be operated at 230 volts (U.S. use): Use a UL-listed and CSA-certified cord set consisting of a minimum 18 AWG, Type SVT or SJT,

three-conductor cord, a maximum of 15 feet in length and a tandem blade, grounding-type attachment plug rated 15 amperes, 250 volts.

For units intended to be operated at 230 volts (outside the U.S.): Use a cord set with a grounding-type attachment plug. The cord set should have the appropriate safety approvals for the country in which the equipment will be installed.

IBM power cords for a specific country or region are usually available only in that country or region.

IBM power cord part number	Used in these countries and regions
02K0546	China
13F9940	Australia, Fiji, Kiribati, Nauru, New Zealand, Papua New Guinea
13F9979	Afghanistan, Albania, Algeria, Andorra, Angola, Armenia, Austria, Azerbaijan, Belarus, Belgium, Benin, Bosnia and Herzegovina, Bulgaria, Burkina Faso, Burundi, Cambodia, Cameroon, Cape Verde, Central African Republic, Chad, Comoros, Congo (Democratic Republic of), Congo (Republic of), Cote D'Ivoire (Ivory Coast), Croatia (Republic of), Czech Republic, Dahomey, Djibouti, Egypt, Equatorial Guinea, Eritrea, Estonia, Ethiopia, Finland, France, French Guyana, French Polynesia, Germany, Greece, Guadeloupe, Guinea, Guinea Bissau, Hungary, Iceland, Indonesia, Iran, Kazakhstan, Kyrgyzstan, Laos (People's Democratic Republic of), Latvia, Lebanon, Lithuania, Luxembourg, Macedonia (former Yugoslav Republic of), Madagascar, Mali, Martinique, Mauritania, Mauritius, Mayotte, Moldova (Republic of), Monaco, Mongolia, Morocco, Mozambique, Netherlands, New Caledonia, Niger, Norway, Poland, Portugal, Reunion, Romania, Russian Federation, Rwanda, Sao Tome and Principe, Saudi Arabia, Senegal, Serbia, Slovakia, Slovenia (Republic of), Somalia, Spain, Suriname, Sweden, Syrian Arab Republic, Tajikistan, Tahiti, Togo, Tunisia, Turkey, Turkmenistan, Ukraine, Upper Volta, Uzbekistan, Vanuatu, Vietnam, Wallis and Futuna, Yugoslavia (Federal Republic of), Zaire
13F9997	Denmark
14F0015	Bangladesh, Lesotho, Maceo, Maldives, Namibia, Nepal, Pakistan, Samoa, South Africa, Sri Lanka, Swaziland, Uganda
14F0033	Abu Dhabi, Bahrain, Botswana, Brunei Darussalam, Channel Islands, China (Hong Kong S.A.R.), Cyprus, Dominica, Gambia, Ghana, Grenada, Iraq, Ireland, Jordan, Kenya, Kuwait, Liberia, Malawi, Malaysia, Malta, Myanmar (Burma), Nigeria, Oman, Polynesia, Qatar, Saint Kitts and Nevis, Saint Lucia, Saint Vincent and the Grenadines, Seychelles, Sierra Leone, Singapore, Sudan, Tanzania (United Republic of), Trinidad and Tobago, United Arab Emirates (Dubai), United Kingdom, Yemen, Zambia, Zimbabwe
14F0051	Liechtenstein, Switzerland
14F0069	Chile, Italy, Libyan Arab Jamahiriya
14F0087	Israel

IBM power cord part number	Used in these countries and regions
1838574	Antigua and Barbuda, Aruba, Bahamas, Barbados, Belize, Bermuda, Bolivia, Brazil, Caicos Islands, Canada, Cayman Islands, Costa Rica, Colombia, Cuba, Dominican Republic, Ecuador, El Salvador, Guam, Guatemala, Haiti, Honduras, Jamaica, Japan, Mexico, Micronesia (Federal States of), Netherlands Antilles, Nicaragua, Panama, Peru, Philippines, Taiwan, United States of America, Venezuela
24P6858	Korea (Democratic People's Republic of), Korea (Republic of)
34G0232	Japan
36L8880	Argentina, Paraguay, Uruguay
49P2078	India
49P2110	Brazil
6952300	Antigua and Barbuda, Aruba, Bahamas, Barbados, Belize, Bermuda, Bolivia, Caicos Islands, Canada, Cayman Islands, Colombia, Costa Rica, Cuba, Dominican Republic, Ecuador, El Salvador, Guam, Guatemala, Haiti, Honduras, Jamaica, Mexico, Micronesia (Federal States of), Netherlands Antilles, Nicaragua, Panama, Peru, Philippines, Saudi Arabia, Thailand, Taiwan, United States of America, Venezuela

Index

A

- acoustical noise emissions 4
- activity LEDs
 - CD-ROM drive 27
 - diskette drive 27
- adapter
 - boot options 12
 - considerations 12
 - expansion slot locations 12
 - hot-plug devices 12
 - installing 12
 - slot identification 10, 12
 - specifications 4
 - working with 10
- attention notices 5

B

- Boot Manager, Extensible Firmware Interface program 33

C

- caution statements 5
- CD-ROM
 - problems 41
- Class A electronic emission notice 61
- components
 - location of 6
 - locations of 6
 - major 6
- configuration
 - Configuration/Setup Utility 33
 - EFI Boot Manager 33
 - EFI shell 33
 - LSI Logic Configuration Utility 33
 - Remote Supervisor Adapter 33
- Configuration/Setup Utility 33
- configuring
 - your server 33
- connectors
 - adapter 10
 - cable 22
 - DIMM 20
 - external port 24
 - microprocessor 14
 - port 22
 - remote I/O enclosure 25
 - SCSI 24
 - USB 24
 - video 24
- cooling 4
- cover
 - close 22
- custom configuration 33

D

- danger statements 5
- diagnostic tools 37
- DIMMs
 - considerations 21
 - order of installation 20
 - specifications 4
 - supported 4
- diskette drive
 - activity LED 27
 - specifications 4
- DVD/CD-RW
 - drive specification 4

E

- eject button
 - diskette 27
 - DVD/CD-RW 27
- electrical input 4
- electrical safety information vi
- electronic emission Class A notice 61
- environment
 - air temperature 4
 - humidity 4
- error messages
 - POST 37
- Ethernet activity LED 28
- Ethernet-link status LED 28
- expansion enclosure 25
- expansion slots 4
 - location 10
 - type 10
- Extensible Firmware Interface (EFI) Boot Manager 33

F

- FCC Class A notice 61
- features, server 4

H

- handling static-sensitive devices 10
- hard disk drive activity LED 27
- hard disk drive status LED 27
- hardware problems 37
- heat output 4
- hot-swap drive
 - specifications 4

I

- important notices 5
- indicators 27
- information label 1
- information LED 27

- information light 27
- installation
 - order, microprocessors 14
- installing
 - adapters 12
 - DIMMs 20
 - memory module 20
 - microprocessors 14
 - options 9
 - PCI adapters 10
- integrated functions 4
- intermittent problems 41

K

- keyboard problem 41

L

- LEDs
 - Ethernet activity 28
 - Ethernet link 28
 - front view 27
 - hard disk drive activity 27
 - hard disk drive error 27
 - information 27
 - locator 27
 - power-on 27
 - rear view 28
 - Remote Supervisor Adapter 28
 - SCSI activity 27
 - system error 27
- Light Path Diagnostics
 - feature 38
 - using 38
- Light Path Diagnostics table 39
- LSI Logic Configuration Utility
 - description 33
 - starting 34
- LSI Logic Configuration Utility program 33

M

- major components 6
- memory
 - problem 42
 - specifications 4
- memory board illustration 20
- memory module specifications 4
- microprocessor
 - heat sink 14
 - installing 14
 - order of installation 14
 - power module 14
 - specifications 4
 - Web site 14
- microprocessor board illustration 14
- microprocessor specifications 4
- mouse problem 42

N

- NOS
 - controlling remotely 34
- notes 5
- notes, important 60
- notices
 - electronic emission 61
 - FCC, Class A 61
- notices and statements 5

O

- operating system
 - controlling remotely 34
- option
 - problem 43
- options
 - installing 9
- order of installation
 - memory modules 20
 - microprocessors 14
- order of installation, microprocessors 14

P

- PCI
 - bus identification 12
 - expansion slots 10
- pointing device
 - problem 42
- port connectors 28
- POST (Power-on self test)
 - error logs 37
- POST error messages 37
- power
 - problem 43
 - supply specifications 4
- power control button 28
- power cords 63
- power-control button shield 30
- power-on LED 27
- problem
 - CD-ROM 41
 - hardware 37
 - intermittent 41
 - keyboard or mouse 41
 - memory 42
 - option 43
 - power 43
 - serial port 43
 - software 44
 - solving 37
 - USB port 44
- product
 - data 1

R

- rack considerations 22
- rack, installing your server in 22

- reliability considerations 9
- remote I/O enclosure 25
- Remote Supervisor Adapter 34
 - configuration 33
- removing
 - memory-board assembly 14
 - microprocessor-board assembly 14
- reset button 28

S

- safety information
 - battery vi
 - electrical vi, viii
 - laser vii
 - lifting vii
 - power supply viii
- serial port
 - problem 43
- size 4
- slots
 - See expansion slots
- software
 - problem 44
- specifications 4
- Standby mode 30
- starting the server 30
- statements and notices 5
- static electricity 10
- static sensitive devices, handling 10
- system reliability 9

T

- temperature
 - air 4

- thermal material
 - heat sink 16
- thermal specifications 4
- trademarks 60
- troubleshooting 37
 - charts 41
- turning off the server 30
- turning on the server 30

U

- United States electronic emission Class A notice 61
- United States FCC Class A notice 61
- USB port
 - problem 44
- utility
 - Configuration/Setup 33
 - EFI Boot Manager 33
 - LSI Logic Configuration 33

V

- video controller
 - specifications 4

W

- Web site
 - compatible options 9, 15, 20
 - DIMM specifications 21
 - microprocessor information 15
- weight 4
- working inside server with power on 9



Part Number: 88P9193

Printed in the United States of America

88P9193

