

Setup

Hardware Requirements

This monitor requires a computer with a suitable on-board sub-system or Video Adapter card that can support SXGA 1280 x 1024, XGA 1024 x 768, SVGA 800 x 600, or VGA 640 x 480 at 60 Hz. For optimal performance, the recommended video setting is 1280 x 1024 at 60 Hz. The monitor has the capability to receive input either from an analog graphics adapter or a Digital Visual Interface DVI-D graphics adapter. If your PC is not already equipped with a suitable graphics adapter, you must install one. If needed, contact your dealer to purchase a compatible graphics adapter.

Handling Instructions

Do not support the monitor within the screen area. The Liquid Crystal Display is glass and can be damaged by rough handling or excessive pressure.

1. Lift the monitor by placing your hands where indicated below.

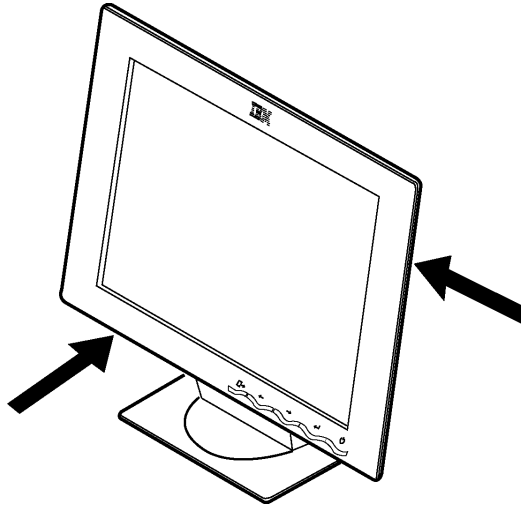

2. Before using your monitor for the first time, remove the clear protective film from the front of the screen.

Workplace Preparation

i This section gives advice on what you should consider before you set up your monitor.

Height

The monitor should be positioned so that the top of the screen is slightly below your eye level when you sit at your workstation.

Orientation

Choose a position that gives the least reflection from lights and windows, usually at a right angle to any windows. The monitor should be positioned directly in front of you so that you do not have to twist your body to use it. Tilt the monitor to a comfortable viewing angle.

Adjusting the Monitor Position

Viewing Angle

You can tilt and swivel the screen backward and forward as shown below.

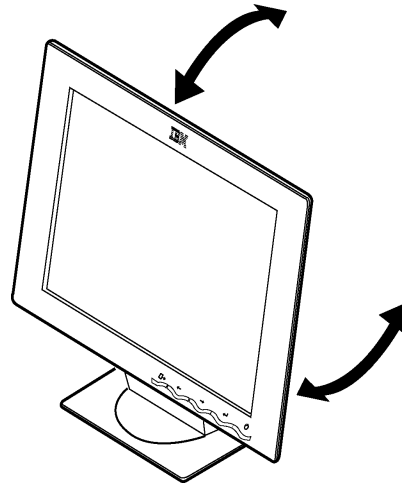

Working Practices

***i** This section gives advice on how you can work comfortably and reduce fatigue.*

Rest

Take regular breaks. Vary your posture, stand up and stretch occasionally as prolonged use of computer workstations can be tiring.

Back

You should sit back in your chair and use the backrest.

Hands

Adjust the seat height so that your forearms are approximately horizontal and your wrists are straight when using the keyboard. Your upper arms should be relaxed with your elbows near your body.

Use a light touch on the keyboard, keeping your hands and fingers relaxed. Allow a space in front of the keyboard to rest your wrists when not typing. Consider using a wristpad.

Eyesight

Working with monitors, in common with any prolonged close work, can be visually demanding. Look away from the screen periodically and have your eyesight checked regularly.

Screen settings

Set the screen brightness and contrast to a comfortable level. You may have to adjust this as the lighting changes during the day. Many application programs let you select color combinations which can help you to view in comfort. See the **User controls** section on page 15 for more information.

Caring for your Monitor

Be sure to turn off the power before you perform any maintenance on the monitor. Clean your monitor as follows:

- Gently wipe the device covers and the screen with a soft cloth.
- Remove finger marks and grease with a damp cloth and mild detergent; do not use solvents or abrasives
- Never use flammable cleaning material to clean your IBM monitor or any other electrical apparatus.

Connecting your Monitor for Analog

Be sure to read the **'Safety Information'** at the front of this User Guide before carrying out this procedure.

1. Turn off your PC and all attached devices.
2. Connect the signal cable to the video port on the back of your computer. This port might be directly attached to your computer (figure A), or it might be part of a video adapter card (figure B). The video port on your computer or video adapter card may be colored blue to match the blue connector on your monitor's video cable.

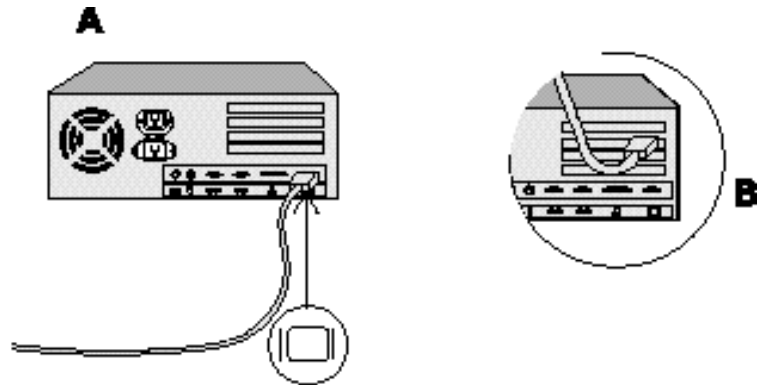

i The AC adapter and signal cable are connected to your monitor. If you wish to change these or to fit a different stand, see **Further Help** on page 26.

3. Connect the power cord to the power adapter first, then insert the plug into a properly grounded electrical outlet.

Connecting your Monitor for Digital

1. Turn off your PC and all attached devices.
2. Remove rear covers a, b and c per instructions 2, 3 and 4 on page 26.
3. Locate DVI cable. It is shipped in a separate plastic bag in the shipping carton.

Connecting DVI Cable

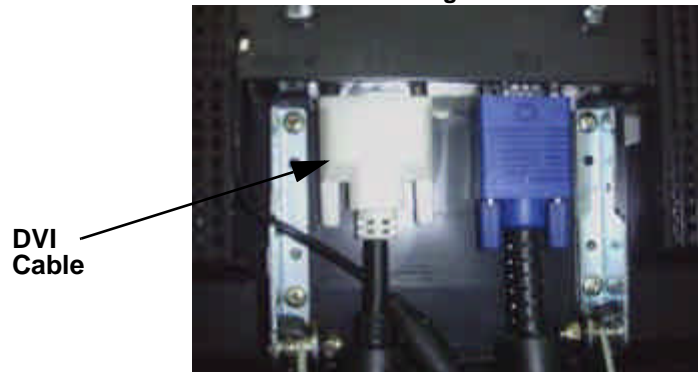

4. Connect the DVI connector at the end of the signal cable to the DVI port located on the back of the Monitor. See above picture.
5. Connect the DVI connector at the other end of the signal cable to the DVI port located on the back of the graphics adapter. See picture below.

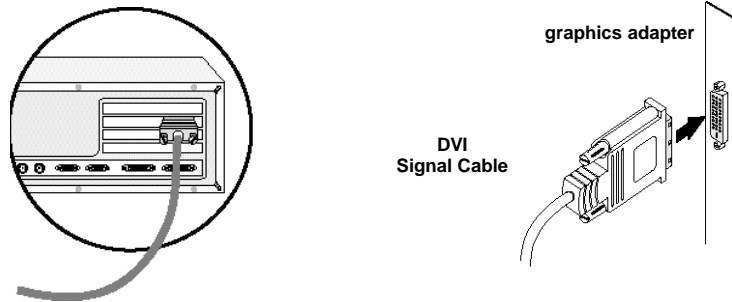

6. Replace the rear covers.
7. Connect the power cord to the power adapter first, then insert the plug into a properly grounded electrical outlet.
8. Switch on the power source and your computer. To turn on the monitor, push and release the power switch . To switch it off, push and release the power switch again.

Switching on your Monitor

1. Switch on the power source and your computer.
2. Switch on your monitor by pushing and releasing the power switch marked .
To switch off your monitor, push and release the power switch again.
3. Turn on the monitor and then the computer.
4. Run AUTO SETUP by following the instructions in the **Configuring your Monitor** section on page 7.

Configuring your Monitor

Setup Diskette for Windows95 or Windows 98

This section must be completed before continuing with the Windows 95 or Windows 98 Auto Setup on Page 10.

***i** On LCD monitors, unlike CRTs, a faster refresh rate does not improve display quality. IBM recommends using either 1280 x 1024 at a refresh rate of 60Hz.*

To use the Plug and Play feature in Windows 95 or Windows 98, files should be loaded from the **IBM Flat Panel Monitor Installation diskette**:

1. Turn off the computer and all attached devices.
2. Ensure that the monitor is connected correctly.
3. Turn on the monitor and then the system unit. Allow the system to boot into Windows 95 or Windows 98.
Your computer's Plug and Play code may warn you that your system hardware has changed. This probably means that it has detected your new monitor for the first time.
4. Open the DISPLAY PROPERTIES window by clicking on START, SETTINGS, CONTROL PANEL and then double clicking on the DISPLAY icon.
5. Select the SETTINGS tab.
 - **In case of Windows 95:**
6. -1. Select the Change Display Type button.
2. Select the Change Monitor Type button.
 - **In case of Windows 98:**
6. -1. Select the ADVANCED BUTTON.
2. Select the MONITOR tab.
3. Open the UPGRADE DEVICE WIZARD windows by clicking on Change button and then select the NEXT button.
If the UPGRADE DEVICE WIZARD is open go step 6-3. if not continue to step 4.
4. Select the "Display a list of the known drivers for this device so that I can choose a specific driver" and then select the NEXT button.
7. Insert the Setup diskette into drive A: and select the HAVE DISK button.
8. Select OK.
9. Choose IBM T84H monitor and select OK. The files will be copied from the diskette to your hard drive.
10. Close all open windows and remove the diskette.
11. Reboot the system.
The system will automatically select the maximum refresh rate and corresponding Color Matching Profiles.

Setup Diskette for Windows 2000

This section must be completed before continuing with the Windows 2000 configuring for your monitor on page 10.

i *On LCD monitors, unlike CRTs, a faster refresh rate does not improve display quality. IBM recommends using either 1280 x 1024 at a refresh rate of 60Hz.*

To use the Plug and Play feature in Windows 2000, files should be loaded from the **IBM Flat Panel Monitor Installation diskette**.

1. Turn off the computer and all attached devices.
2. Ensure that the monitor is connected correctly.
3. Turn on the monitor and then the system unit. Allow the system to boot into Windows 2000.
4. Open the DISPLAY PROPERTIES window by clicking on START, SETTINGS, CONTROL PANEL and then double clicking on the DISPLAY icon.
5. Select the SETTINGS tab.
6. Select the ADVANCED button.
7. Select the MONITOR tab.
8. Select the PROPERTIES button.
9. Select the Driver tab.
10. Open the Upgrade Device Driver Wizard window by clicking on UPDATE DRIVER and then select the NEXT button.
11. select the "Display a list of the known drivers for this device so that I can choose a specific driver" and then select the NEXT button.
12. Insert the Setup diskette into drive A: and select the HAVE DISK button.
13. select OK.
14. Choose IBM T84H monitor and select OK. The files will be copied from the diskette to your hard drive.
15. Close all open windows and remove the diskette.
16. Reboot the system.
The system will automatically select the maximum refresh rate and corresponding Color Matching Profiles.

Auto Setup(Analog Only)

Auto Setup

***i** Before carrying out this section, it is very important that The Setup Diskette for Windows 95 or Windows 98 has been run. (see page 6)*

***i** The Setup Utility included on the setup diskette is for displaying do patterns. They do not replace or modify the display driver.*

***i** The Auto Setup instructions require the monitor to be warmed up for 15 minutes. This is not required for normal operation.*

When you first use your monitor you must perform Auto Setup. This procedure sets up your monitor to process the video signals from your computer without image discoloration or smearing. After you perform Auto Setup, the settings are stored and used each time you turn on the monitor.

In order to optimise the displayed image a set-up utility is provided on the IBM Monitor Installation Diskette. Operation of the utility is dependent on the operating system on your PC. For correct operation locate the operating system on your PC from the table below and follow the appropriate instructions. You may choose to run AUTO SETUP for each operating system that you use. This means that if you sometimes use your monitor while running any version of Windows and sometimes also use it from within DOS (not a DOS window), you must run AUTO SETUP for both Windows and DOS. You may run versions of AUTO SETUP in any order.

Operating System	Corresponding Auto Setup procedure
DOS	Auto Setup for DOS on page 9
Windows 3.1	Auto Setup for Windows 3.1, Windows 95, Windows 98, Windows 2000 or Windows NT on page 10
Windows 95	
Windows 98	
Window 2000	
Window NT	

***i** If your PC does not run with the setup diskettes shipped with the monitor, refer to Manual Setup on page 12*

***i** The AUTO SETUP process only applies to the current screen mode. When a new mode is selected, repeat this section to reset the monitor*

Before you begin AUTO SETUP for your PC:

1. Make a backup copy of the setup diskettes supplied with the monitor.
2. Make sure the PC's video mode is set in the range of the supported screen resolution shown in the table on page 18.

You should perform AUTO SETUP for each screen mode you use.

Auto Setup for DOS





***i** If the monitor is in standby mode (STANDBY ON), it may automatically turn off while you are waiting for it to warm up. If this happens, switch off the monitor and switch it on again after a few seconds.*

***i** If you are using PC-DOS/ V, change to U.S. mode by typing 'CHEV US' and pressing ENTER at the command prompt.*

You must use DOS when you run DOS Auto Setup.

***i** The size and diversity of the dot pattern varies with the screen resolution.*

***i** If the screen flickers, repeat the setup several times until the flicker is minimised, or adjust it manually by following **Manual Setup** on page 14.*

1. Turn on the monitor first; then the PC.
If the message CHECK SIGNAL CABLE is displayed, or if nothing is displayed check:
 - that the video interface cable is connected properly.
 - the correct video adapter card is installed.
 - the correct supported display mode is selected for your PC.
2. Wait approximately 15 minutes, until the monitor warms up.
3. Insert the diskette labelled 'IBM Flat Panel Monitor Installation Diskette' into the diskette drive.
4. Display the command prompt screen of the DOS full-screen display.
5. At the command prompt, type 'A:' and press ENTER.
6. Type 'TESTPATD' and press ENTER.
7. Select from the screen the number for the color or text mode you want to setup.
8. Select from the screen the number for the video mode you want to setup.
You may repeat this process for as many of the color and video modes as you need.
9. When the dot pattern appears, press the OSD Enter button  at the bottom of the monitor to display the initial OSD menu.
10. Use an Arrow button (← or →) to select the IMAGE LOCK icon  then press the OSD Enter  button to access the function.
11. Using an Arrow button (← or →), select AUTOMATIC and press the OSD Enter button . This activates the AUTO SETUP procedure, which will optimize the display settings with the provided dot-patterns.
The screen will blink off several times and you may notice small changes to the test pattern.
12. When finished, the OSD main menu returns. Press the Exit button  to exit from the OSD.
13. Press the ESCAPE key to exit the test pattern program.
14. Type 'Exit' at the command prompt to return to Windows.

If you use other operating systems, perform the appropriate AUTO SETUP for those systems, also: see **Auto Setup for Windows 3.1, Windows 95, Windows 98, Windows NT or Windows 2000 on page 10.**

Auto Setup for Windows 3.1, Windows 95, Windows 98, Windows NT or Windows 2000





i If the monitor is in standby mode (STANDBY ON), it may automatically turn off while you are waiting for it to warm up.

i The size and diversity of the dot pattern varies with the screen resolution.

i Position the mouse pointer at the bottom center of the screen. This allows AUTO SETUP to run properly

1. Turn on the monitor first; then the PC.
If the message CHECK SIGNAL CABLE is displayed, or if nothing is displayed check:
 - that the video interface cable is connected properly.
 - the correct video adapter card is installed.
 - the correct supported display mode is selected for your PC.
2. Wait approximately 15 minutes, until the monitor warms up.
3. Drag the icon bar and tool bar, if they are displayed, to the bottom of the screen.
4. Insert the diskette labelled 'IBM Flat Panel Monitor Installation Disk' into the diskette drive.
5. Check the operating system installed on your PC and follow the instructions from the table below.

Operating System	Step1	Step2	Step3	Step4
Windows 3.1	Open PROGRAM MANGER	Select FILE	Select RUN	Type 'A:\TESTPAT' and press ENTER
Windows NT 3.5				
Windows 95	Select START	Select RUN		
Windows 98				
Windows NT 4.0				

6. When the test pattern appears, press the OSD Enter button  at the bottom of the monitor to display the initial OSD menu.
7. Use an Arrow button (← or →) to select the IMAGE LOCK icon  and press the OSD Enter button  to access the function.
8. Using an Arrow button (← or →), select AUTOMATIC and press the OSD Enter button . This activates the AUTO SETUP procedure, which will optimize the display settings with the provided test pattern.
The screen will dim, blink on and off several times, and you may notice small changes to the test pattern.
To abort the AUTO SETUP function, press the Esc key.
9. When finished, the OSD main menu returns. Press the Exit button  once to exit from the OSD.







10. Press the Esc key to return to Windows.

You have completed the monitor setup for Windows. If you use other operating systems, perform the appropriate `AUTO SETUP` for those systems, also: see **Auto Setup for DOS** on page 10.

Manual Setup

***i** If the monitor is in standby mode (STANDBY ON), it might automatically turn off while you are waiting for it to warm up.*

Normally, you can complete the setup procedure using AUTO SETUP, however, if your screen image is still distorted after you perform AUTO SETUP or the setup diskette does not run on your system, perform MANUAL SETUP.

1. Have your monitor turned on for about 15 minutes, until the monitor warms up.
2. Display the image you most frequently use on the screen.
3. Press the OSD Enter button  at the bottom of the monitor to display the initial OSD menu.
4. Use an Arrow button (← or →) to select the IMAGE LOCK icon  and press the OSD Enter button  to access the function.
5. Using an Arrow button (← or →), select MANUAL, press  and then press → once to select COARSE. Left and right arrow adjustment indicators become illuminated (see page 18).
6. Use the Arrow buttons to manually adjust to correct (as much as possible) for noise in the video signal then press  to save the changes.
7. Use an Arrow button to select FINE and press the  button.
8. Use the Arrow buttons again to tune the image to your liking.
9. When finished, press the Exit button  four times to exit from the OSD.

You have completed the monitor setup.

Adjusting Your LCD Monitor

User controls



User control features

Icon	Control	Description
	Exit	OSD inactive: Switches the video input source OSD active: Exits from menus and sub-menus Exits the OSD
	Left Arrow	Displays the OSD main menu Moves the cursor to highlight icons and other options
	Right Arrow	Displays the OSD main menu Moves the cursor to highlight icons and other options
	OSD Enter	Displays the OSD main menu Enters menus and sub-menus and selects the highlighted option
	Power Switch	Switches the monitor on and off

Operation

i The image is already optimized for many display modes, however the user controls can be used to adjust the image to your liking.

- Press any of the OSD control buttons to display the main OSD menu.
- Use the Arrow buttons to move among the icons. Select an icon and press OSD Enter to access that function. If there is a sub-menu, you can move between options using the Arrow buttons, then press OSD Enter to select that function. Use the Arrow buttons to make adjustments.

i The settings are saved after adjustment and when exiting the OSD and will be effective thereafter.

- Press the Exit button to move backwards through the sub-menus and exit from the OSD.

Note: After making adjustments, the Power indicator LED will briefly turn amber to indicate that the new value has been saved.

OSD Lock / Unlock

This feature allows you to secure the current control settings, while allowing the user to adjust Brightness and Contrast, so that they cannot be inadvertently changed. You can unlock the OSD controls at any time by using the same procedure.

Push and hold the OSD Enter button for 10 seconds to Lock or to Unlock. When locked, a "LOCKED" message will be displayed.

On-screen display (OSD) controls

The settings adjustable with the user controls are viewed through the On-Screen Display (OSD). Press any of the OSD buttons to activate the OSD.





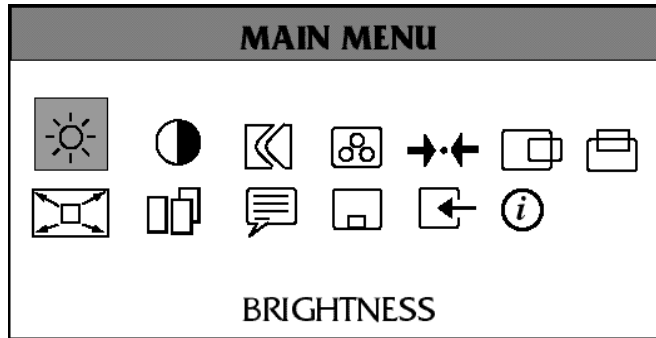





i The LCD monitor needs time to become thermally stable the first time you turn it on each day. Thus, to achieve more accurate adjustments for parameters, allow the LCD monitor to warm up (be On) for at least 15 minutes before making any screen adjustments.







Initial appearance of OSD



OSD functions

OSD Icon	Description	Sub-menu(s)	Controls and Adjustments(Analog)		Controls and Adjustments(Digital)
 BRIGHTNESS	Adjusts brightness				Same as Analog
 CONTRAST	Adjusts contrast				Controls Locked
 IMAGE LOCK	The image lock function is used to adjust the level of noise in the video signal which causes horizontal lines or areas on the screen where the image appears to be unstable and jitters or shimmers. This can be done automatically or manually.	AUTOMATIC	Automatic adjusts the monitor.		Controls Locked

OSD Icon	Description	Sub-menu(s)	Controls and Adjustments(Analog)	Controls and Adjustments(Digital)
 IMAGE LOCK <i>(continued)</i>		MANUAL - • Fine • Coarse	Use the Arrow buttons to adjust away the interference. If satisfactory results are not obtained using the Fine adjustment, use the Coarse adjustment and then use Fine again. This function may change the width of the display image. Use the H-Position function to center the display image on the screen.	Controls Locked
 COLOR	Select the preset Color mode you find most comfortable and then fine tune the colors using the User submenu, if necessary.	PRESET	1 - (Cool White) 2 - (Normal White) 3 - (Warm White)	Controls Locked
		USER • Red • Green • Blue	Increases or decreases redness Increases or decreases greenness Increases or decreases blueness	
 RESET	Resets the Brightness, Contrast, Image Lock Fine and Coarse, Color, H-Position, V-Position, and Display Size settings.		NO - Does not make the adjustment YES - Resets the settings	Controls Locked
 H-POSITION	Moves the screen left and right.		 	Controls Locked
 V-POSITION	Moves the screen down and up.		 	Controls Locked
 DISPLAY SIZE	If your computer or video board supplies a signal rate and addressability lower than 1280 x 1024, this LCD monitor provides a scaling processor that can expand the addressability up to 1280 x 1024.	EXPANDED	1 - Image enlarged to fill the entire screen. 2 - Image enlarged to fill the width of the screen only.	Same as Analog
		NORMAL	Image at normal size.	

OSD Icon	Description	Sub-menu(s)	Controls and Adjustments(Analog)	Controls and Adjustments(Digital)
 IMAGE EFFECT	Select this icon to optimize the display for the type of software you are using. Scaling smooths an image which may help the eye to see more detail. Filtering sharpens text by adding a fine, contrasting line around each character so that it is easier to recognize.	SCALING	ON - Turns Scaling on. OFF - Turns Scaling off.	Same as Analog
		FILTER	ON - Turns Filtering on. OFF - Turns Filtering off.	
 LANGUAGE	The language chosen affects only the language of the OSD. It has no effect on any software running on the computer.	Select one of the five languages to use for the OSD.		Same as Analog
 OSD MENU POSITION	Changes the position of the OSD on the screen.	H-POSITION		Same as Analog
		V-POSITION		
 INPUT SELECTION	This monitor can accept video signals through two different connectors. Most desktop computers use a D-SUB connector. Select DVI-D among OSD controls when you use DVI connector.	1 - selects D-SUB (Analog) 2 - selects DVI-Analog 3 - selects DVI-Digital		Same as Analog
 INFORMATION	Shows information about the addressability and the horizontal and vertical frequencies available. The current setting for the images received from the computer or video board is displayed along the bottom of both submenus.	USER MODES	Lists all modes which you have defined by making changes using the OSD controls	Same as Analog
		PRESET MODES	Lists all modes that have been defined during manufacture	

Further Information

Display modes

The display mode the monitor uses is controlled by the computer. Therefore, you should refer to your computer documentation for details on how to change display modes.

The image size, position and shape may change when the display mode changes. This is normal and the image can be readjusted using AUTO SETUP and the monitor controls.

Unlike CRT monitors, which require a high refresh rate to minimize flicker, TFT technology is inherently flicker-free. If possible, configure your computer for 1280 × 1024 addressability at 60Hz vertical refresh rate.

For the display modes listed below, the screen image has been optimized during manufacture.

Factory Set Display Modes

i For image problems, you may want to run **AUTO Setup** again before consulting to this section. In most cases, **AUTO SETUP** can fix the problems. See **Auto Setup** on page 8 for details.

Addressability	Refresh Rate	Horizontal Frequency	Analog	Digital
640 × 350	70 Hz	31.5 kHz	O	O
640 × 480	75 Hz	37.5 kHz	O	O
640 × 480	72 Hz	37.8 kHz	O	O
640 × 480	66 Hz	35.0 kHz	O	O
640 × 480	60 Hz	31.5 kHz	O	O
720 × 400	70 Hz	31.4 kHz	O	O
800 × 600	56 Hz	35.1 kHz	O	O
800 × 600	60 Hz	37.8 kHz	O	O
800 × 600	72 Hz	48.0 kHz	O	O
800 × 600	75 Hz	46.8 kHz	O	O
832 × 624	75 Hz	49.7 kHz	O	O
1024 × 768	60 Hz	48.4 kHz	O	O
1024 × 768	70 Hz	56.5 kHz	O	O
1024 × 768	75 Hz	60.0 kHz	O	O
1280 × 1024†	60 Hz	64.0 kHz	O	O
1280 × 1024	70 Hz	74.4 kHz	O	X
1280 × 1024	75 Hz	80.0 kHz	O	X
1280 × 1024	76 Hz	81.1 kHz	O	X
1152 × 864	75 Hz	67.5 kHz	O	X
1152 × 870	75 Hz	68.7 kHz	O	X
1152 × 900	60 Hz	61.8 kHz	O	O

† Recommended

‘Note: VESA timings are as detailed in the VESA “Display Monitor Timing Specification”. Version 1.0, Revision 0.8, dated 09/17/98.’

Power Management

If your computer has previously been used with a CRT monitor and is currently configured to a display mode outside the range that the Flat Panel monitor can display, you may need to re-attach the CRT monitor temporarily until you have re-configured the computer, preferably to 1280 x 1024 at 60Hz.

To benefit from power management, the monitor must be used in conjunction with a computer that implements the Video Electronics Standards Association (VESA) Display Power Management Signalling (DPMS) Standard.

The power management feature is invoked when the computer recognizes that you have not used your mouse or keyboard for a user-definable period. There are several states as described in the table below.

As an ENERGY STAR® Partner, IBM has determined that this product meets the ENERGY STAR® guidelines for energy efficiency.

IBM recommends that you switch off your monitor at the end of each working day, or whenever you expect to leave it unused for long periods during the day.

State	Power Indicator	Screen	Restoring Operation	Compliance
On	Steady green	Normal		
DPMS Standby	Steady amber	Blank	Press a key or move the mouse.	ENERGY STAR® and NUTEK
DPMS Suspend	Flashing amber (0.5 sec. interval)	Blank	Press a key or move the mouse. ‡	ENERGY STAR® and NUTEK
DPMS Off	Flashing amber (1 sec. interval)	Blank	Press a key or move the mouse. ‡	ENERGY STAR® and NUTEK

‡ There may be a slight delay before the picture reappears.

Product Disposal

The fluorescent lamp in the liquid crystal display contains mercury. Dispose of it as required by local ordinances and regulations.

Troubleshooting

If you have a problem setting up or using your monitor, you may be able to solve it yourself. Before calling your retailer or IBM, try the suggested actions that are appropriate to your problem.

Problem	Possible Cause	Suggested Action	Reference
Computer doesn't boot after the graphics adapter is installed	There is another graphics adapter in the computer	<ul style="list-style-type: none">◆ Remove the other graphics adapter plugged into one of the expansion slot.◆ If the card is built-in to the motherboard, check your system manual for instructions on how to disable the built-in adapter.	Connecting your Monitor for Analog section on page 5
The screen image is garbled or unusable (rolling screen images, overlapping screen images or a blank screen)	The display driver is trying to use a setting your monitor doesn't support	<ul style="list-style-type: none">◆ Select the correct monitor again.	Connecting your Monitor for Analog section on page 5

Problem	Possible Cause	Suggested Action	Reference
Screen is blank and power indicator is off	No power to monitor	<ul style="list-style-type: none"> ◆ Ensure that the electrical outlet and the monitor are both switched on. ◆ Check that the power cord is firmly plugged into the electrical outlet and the power supply unit. ◆ If the power cord plug has a removable fuse, replace it. ◆ Try another power cord. ◆ Try another electrical outlet. 	Connecting your Monitor for Analog section on page 5
Screen is blank and power indicator is steady green	Brightness and Contrast may be too low	<ul style="list-style-type: none"> ◆ Adjust brightness and contrast. 	User controls section on page 15
Screen is blank and power indicator is steady amber	The monitor is in the Power Management Standby state	<ul style="list-style-type: none"> ◆ Press any key on the keyboard or move the mouse to restore operation. ◆ Check the Power Management software on your computer 	Power Management section on page 19
Screen is blank and power indicator is Flashing green every 0.5 second	The monitor is not receiving a video signal	<ul style="list-style-type: none"> ◆ Check that the signal cable is firmly connected to the computer. ◆ Check that no pins are bent in the signal cable connector. 	Connecting your Monitor for Analog section on page 5
	Display mode of the computer is outside the range of the monitor	<ul style="list-style-type: none"> ◆ Reconfigure the computer to use a supported display mode. 	Further Information section on page 20

Problem	Possible Cause	Suggested Action	Reference
Screen is blank and power indicator is flashing amber every 0.5 or 1 second	The monitor is in the Power Management Suspend or Off state	<ul style="list-style-type: none"> ◆ Press any key on the keyboard or move the mouse to restore operation. ◆ Check the Power Management software on your computer. 	Power Management section on page 19
Image appears to be smeared	There are noises in the video signal	<ul style="list-style-type: none"> ◆ Select IMAGE LOCK menu in the OSD. Then select MANUAL to adjust FINE/COARSE settings. 	User controls section on page 15
Image appears to be discolored	The Color setting may be incorrect	<ul style="list-style-type: none"> ◆ Adjust the Color settings. 	User controls section on page 15
A few dots are missing, discolored, or inappropriately lighted.	<ul style="list-style-type: none"> ◆ The LCD contains over 3,900,000 thin-film transistors (TFTs). A small number of missing, discolored, or lighted dots may be present on the screen, which is an intrinsic characteristic of the TFT LCD technology and is not an LCD defect. 		

i *Power consumption figures are for the monitor and the power supply combined.*

Further Help

If you are unable to correct the problem yourself, you may seek further help as follows:

Call the IBM HelpCenter(R).

In the US call 1-800-772-2227

In Canada (Toronto Only) call 416-383-3344

In Canada (all others) call 1-800-565-3344

In other countries contact your dealer, retailer, or other IBM authorized Servicer.

***i** If possible, stay by your computer. Your Technical Support Representative may wish to go through the problem with you during the call.*

Before calling, please have available as much of the following information as possible:

1. Model and serial number from the label on your monitor.
2. Purchase receipt.
3. Description of problem.
4. Computer type and model.
5. System configuration (hardware fitted, etc.).
6. System BIOS version number.
7. Operating System and version number.
8. Display driver version number.
9. Video Adapter Type.

***i** More help, late-breaking news and details of the latest accessories for these products may be found on the worldwide web at:*

<http://www.pc.ibm.com/us/accessories>

Information about the Video Electronics Standards Association can be found on the worldwide web at:

<http://www.vesa.org>

Removing the stand and cables

Alternative stands for your IBM Flat Panel Monitor may be available from specialist suppliers.

This product is equipped with mounting facilities that conform to the VESA Flat Panel Monitor Physical Mounting Interface Standard (FPMPMI).

This product is shipped with the signal cable and the power cord attached to the monitor. If you want to use other cables for reasons such as having the monitor wall-mounted, follow the instructions below:

1. Disconnect the power cord from the wall outlet.

- Carefully insert the head of a flathead (–) screwdriver into the slot visible along either side of the cable cover (a) and pry it off.

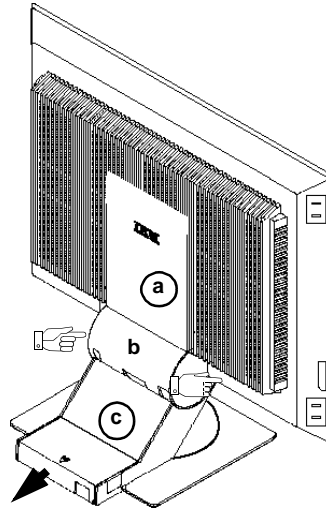

- Squeeze the sides of the hinge cover (b) and pull it off.
- Gently lift the stand cover (c) along the top and then slide it backwards and off the stand.
- Remove the signal cable and the power cord from the monitor by disconnecting the corresponding adapters. Carefully cut the plastic tie to free the power cord and remove the screw holding the power cord clamp.
- Lay the monitor facedown on a cushion and remove the six screws holding the hinge mechanism on the monitor. Lift off the hinge and base assembly.
- If you are installing an arm or wall-mounting device, follow the directions included with the device. If you are just changing your cables, continue with Step 8.
- Connect the signal cable and the power cord, then refit the power cord clamp in its original screwpost.
- Slide the stand cover back on the stand.
- Put the hinge cover back on, making sure that the straight side is at the top.
- Insert the three tabs at the top of the cable cover into the slots in the back of the monitor and push the cover into place.

To obtain the correct cables and/or to get further instructions on installing them, call the IBM HELPCENTER at the above numbers or contact your dealer, retailer, or other IBM authorized Servicer.

Specifications

This color monitor (Type-model 6658-Hxx) uses a 18.1-inch TFT LCD

Dimensions	Width: Depth: Height:	462 mm (18 in.) 233 mm (9 in.) 458 mm (18 in.)
Weight	Unpackaged: Packaged:	9.0 Kg (19.8 lb) 12.0 Kg (30.5 lb)
Tilt / Swivel	Tilt: Swivel:	- 4° / + 41° - 230° / + 90°
Image	Viewable Image Size: Maximum Height: Maximum Width: Pixel Pitch:	459.7 mm (18.1 in.) 287 mm (11 in.) 359 mm (14 in.) 0.281 mm (.011 in.) (H) × 0.281 mm (.011 in.) (V)
Power Input	Supply Voltage: Max Supply Current:	90 - 260 Vac, 60/50 ± 3 Hz 1.5 A at 120 Vac
Power Consumption	Normal Operation: DPMS Stand-by: DPMS Suspend: DPMS off:	< 48 W < 3 W for Analog, < 4 W for Digital < 3 W for Analog, < 4 W for Digital < 3 W for Analog, < 4 W for Digital
Video Input(Analog)	Input Signal: Horiz. Addressability: Vert. Addressability: Clock Frequency:	Analog Direct Drive, 75 ohm 0.7 V 1280 pixels (max) 1024 lines (max) 135 MHz
Video Input(Digital)	Interface: Input Signal: Horiz. Addressability: Vert. Addressability: Clock Frequency:	DVI VESA TMDS (Panel Link ™) 1280 pixels (max) 1024 lines (max) 106 MHz
Communications	VESA DDC:	2 B
Supported Display Modes	VESA Standard modes between Horiz. Frequency: Vert. Frequency:	IBM, VESA, HP, Sun, Mac 30 kHz - 64 kHz for Digital 30 kHz - 82 kHz for Analog 56 Hz - 75 Hz

Environment	Temperature:	
	Operating:	10 to 35° C (50 to 95° F)
	Storage:	- 20 to 60° C (-4 to 140° F)
	Shipping:	- 20 to 60° C (-4 to 140° F)
	Humidity:	
	Operating:	10 to 80%
Storage:	5 to 95%	
Shipping:	5 to 95%	

Warranty Statements

Warranty period - Three (3) years

Your Installation Diskette includes translation of IBM's Statement of
Warranty in following languages:

Worldwide Statement of Warranty (Except Turkiye, U.S., Puerto Rico and Canada):	
Arabic	Z1255697.ara.html
Brazilian portuguese	Z1255697.bra.html
Bulgarian	Z1255697.bul.html
Chinese	Z1255697.chi.html
Croatian	Z1255697.cro.html
Czech	Z1255697.cze.html
Danish	Z1255697.dan.html
Dutch	Z1255697.dut.html
English	Z1255697.eng.html
Finnish	Z1255697.fin.html
French	Z1255697.fre.html
German	Z1255697.ger.html
Greek	Z1255697.gre.html
Hebrew	Z1255697.heb.html
Hungarian	Z1255697.hun.html
Italian	Z1255697.ita.html
Japanese	Z1255697.jap.html
Korean	Z1255697.kor.html
Norwegian	Z1255697.nor.html
Polish	Z1255697.pol.html
Portuguese	Z1255697.por.html
Russian	Z1255697.rus.html
Slovakian	Z1255697.sla.html

Slovenian	Z1255697.sle.html
Spanish	Z1255697.spa.html
Swedish	Z1255697.swe.html
Taiwanese	Z1255697.tai.html

Turkiye Statement of Warranty:

Turkish	Z1255698.tur.html
English	Z1255698.eng.html

United States, Puerto Rico and Candada Statement of Limited Warranty:

English	Z1254753.eng.html
French Canadian	Z1254753.fca.html